



# **XP-960 User's Guide**



---

# Contents

<b>XP-960 User's Guide</b> .....	<b>13</b>
<b>Product Basics</b> .....	<b>14</b>
Using the Control Panel .....	14
Control Panel Buttons and Lights .....	15
Using the LCD Screen .....	16
Adjusting Control Panel Position .....	16
Changing LCD Screen Language.....	17
Turning Off Control Panel Sounds.....	17
Turning Off Auto Selection Mode.....	17
Turning Off the Document Alert.....	18
Turning On Quiet Mode .....	19
Product Parts Locations .....	19
Product Parts - Top.....	20
Product Parts - Front .....	22
Product Parts - Inside .....	23
Product Parts - Back.....	23
The Power Off and Sleep Timers .....	24
Changing the Power Off Timer Setting From the Control Panel .....	24
Changing the Sleep Timer Setting From the Control Panel .....	25
Changing the Power and Sleep Timer Settings - Windows.....	27
Changing the Power and Sleep Timer Settings - OS X.....	28
Epson Connect Solutions for Smartphones, Tablets, and More .....	29
Using Epson Email Print .....	29
Using the Epson iPrint Mobile App .....	30
Using Epson Remote Print .....	30
Using Epson Scan to Cloud.....	30
Using AirPrint .....	31
Using Google Cloud Print.....	32
Setting Up Google Cloud Print on a Chromebook .....	33
Using the Mopria Print Service .....	34

<b>Wi-Fi or Wired Networking</b> .....	<b>35</b>
Wi-Fi Infrastructure Mode Setup.....	35
Selecting Wireless Network Settings From the Control Panel .....	36
Wi-Fi Direct Mode Setup .....	39
Enabling Wi-Fi Direct Mode .....	40
Wi-Fi Protected Setup (WPS).....	43
Using WPS to Connect to a Network .....	43
Wired Network Setup .....	45
Printing a Network Status Sheet.....	46
Changing or Updating Network Connections .....	46
Accessing the Web Config Utility .....	46
Changing a USB Connection to a Wi-Fi Connection.....	47
Changing a Wi-Fi Connection to a Wired Network Connection.....	47
Connecting to a New Wi-Fi Router .....	48
Disabling Wi-Fi Features .....	48
<b>Loading Paper</b> .....	<b>50</b>
Loading Paper in Cassette 1 (Upper Cassette) .....	50
Loading Paper in Cassette 2 (Lower Cassette) .....	54
Loading Paper in the Rear Paper Feed Slot .....	58
Loading Envelopes.....	63
Selecting the Paper Settings for Each Source - Control Panel .....	66
Printing on Thick Paper .....	68
Turning Off the Paper Setting Alert.....	68
Paper Loading Capacity .....	69
Available Epson Papers .....	70
Borderless Paper Type Compatibility .....	73
Paper or Media Type Settings - Control Panel .....	74
Paper or Media Type Settings - Printer Software .....	74
<b>Placing Originals on the Product</b> .....	<b>76</b>
Placing Originals on the Scanner Glass .....	76
<b>Copying</b> .....	<b>79</b>
Copying Documents or Photos.....	79
Paper Type Settings - Copying .....	80

Paper Size Settings - Copying .....	81
Copying Options .....	81
Copying and Restoring Photos .....	84
<b>Printing from a Computer .....</b>	<b>86</b>
Printing with Windows .....	86
Selecting Basic Print Settings - Windows .....	86
Paper Source Options - Windows .....	89
Print Quality Options - Windows .....	89
Multi-Page Printing Options - Windows .....	90
Selecting Double-sided Printing Settings - Windows .....	90
Double-sided Printing Options - Windows .....	92
Print Density Adjustments - Windows .....	93
Selecting Additional Layout and Print Options - Windows .....	94
Custom Color Correction Options - Windows .....	96
Image Options and Additional Settings - Windows .....	97
Header/Footer Settings - Windows .....	98
Selecting a Printing Preset - Windows .....	99
Selecting Extended Settings - Windows .....	100
Extended Settings - Windows .....	102
Printing Your Document or Photo - Windows .....	103
Checking Print Status - Windows .....	105
Selecting Default Print Settings - Windows .....	105
Changing the Language of the Printer Software Screens .....	106
Changing Automatic Update Options .....	107
Printing with OS X .....	108
Selecting Basic Print Settings - OS X .....	109
Paper Source Options - Mac OS X .....	113
Print Quality Settings - OS X .....	113
Print Options - OS X .....	113
Selecting Page Setup Settings - OS X .....	114
Selecting Print Layout Options - OS X .....	115
Selecting Double-sided Printing Settings - OS X .....	116
Double-sided Printing Options and Adjustments - OS X .....	117

Managing Color - OS X.....	118
Color Matching and Color Options - OS X.....	119
Selecting Printing Preferences - OS X.....	120
Printing Preferences - OS X.....	121
Printing Your Document or Photo - OS X.....	122
Checking Print Status - OS X.....	123
Cancelling Printing Using a Product Button.....	123
<b>Scanning.....</b>	<b>124</b>
Starting a Scan.....	124
Starting a Scan Using the Product Control Panel.....	124
Scan to Memory Card Options.....	126
Changing Default Scan Button Settings.....	127
Starting a Scan Using the Epson Scan Icon.....	127
Starting a Scan from a Scanning Program.....	130
Selecting Epson Scan Settings.....	132
Scan Modes.....	132
Selecting the Scan Mode.....	133
Scanning in Full Auto Mode.....	133
Available Image Adjustments - Full Auto Mode.....	136
Scanning in Home Mode.....	136
Selecting a Scan Area - Home Mode.....	139
Available Image Adjustments - Home Mode.....	142
Selecting a Scan Size - Home Mode.....	143
Scanning in Office Mode.....	146
Selecting a Scan Area - Office Mode.....	147
Available Image Adjustments - Office Mode.....	149
Scanning in Professional Mode.....	150
Available Image Types - Professional Mode.....	153
Selecting a Scan Area - Professional Mode.....	153
Available Image Adjustments - Professional Mode.....	156
Selecting a Scan Size - Professional Mode.....	158
Image Preview Guidelines.....	161
Scan Resolution Guidelines.....	161

Selecting Scan File Settings .....	163
Available Scanned File Types and Optional Settings .....	164
Scanning with OS X Using Image Capture .....	165
Available Scan Settings - OS X Image Capture .....	167
Scanning Special Projects.....	167
Scanning to a PDF File .....	167
Restoring Photo Colors as You Scan .....	170
Scanning to Online Destinations Using Easy Photo Scan .....	171
Scanning Using Easy Photo Scan .....	171
Uploading Scanned Images to Facebook .....	173
Uploading Scanned Images to Picasa .....	175
Uploading Scanned Images to Evernote.....	177
Uploading Scanned Images to SugarSync .....	179
Uploading Scanned Images to a Web Folder.....	181
Uploading Scanned Images to Email .....	183
Saving Scanned Images to a Folder .....	184
Epson JPEG File Settings.....	185
Epson TIFF and Multi-TIFF File Settings .....	186
<b>Using Memory Cards With Your Product .....</b>	<b>188</b>
Inserting a Memory Card .....	188
Memory Card Types .....	189
Memory Card File Specifications .....	190
Removing a Memory Card.....	190
Printing from a Memory Card .....	191
Viewing and Printing Photos.....	191
Viewing and Printing Photos From the LCD Screen.....	191
Cropping Photos Displayed on the LCD Screen .....	193
Photo Adjustment Options - Memory Card.....	193
Print Setting Options - Memory Card .....	194
Paper Type Settings - Memory Card.....	196
Printing Photo Layouts from a Memory Card.....	197
Photo Layout Options .....	198
Printing Photo Greeting Cards.....	199

Creating and Printing a Greeting Card Template .....	199
Printing a Greeting Card from a Template.....	200
Transferring Photos on a Memory Card .....	202
Setting Up File Sharing for Photo Transfers From Your Computer .....	202
Transferring Photos from a Memory Card to Your Computer .....	202
<b>Using an External Device with Your Product .....</b>	<b>204</b>
Printing from a Camera .....	204
Selecting Print and Photo Adjustment Settings .....	204
Print Settings - Camera.....	207
Photo Adjustments - Camera.....	209
Connecting and Printing from a Camera.....	211
Printing from a Camera Wirelessly .....	211
Viewing or Printing from a USB Flash Drive or External Device .....	212
USB Device File Specifications .....	213
Connecting and Using a USB Flash Drive or External Device .....	213
<b>Printing Personalized Projects.....</b>	<b>215</b>
Printing Coloring Book Pages .....	215
Printing Personalized Note Paper .....	217
Printing Lined Paper, Graph Paper, and Music Sheets .....	219
Printing Calendar Pages .....	221
<b>Printing on CDs/DVDs.....</b>	<b>223</b>
CD/DVD Printing Features .....	223
Loading a CD/DVD.....	223
Removing a Printed CD/DVD .....	226
Placing a CD/DVD on the Scanner Glass.....	227
Copying onto a CD/DVD .....	227
Printing Photos from a Memory Card Onto a CD/DVD .....	229
Printing a Jewel Case Insert from a Memory Card .....	231
Printing on CDs/DVDs from a Computer .....	233
Starting Epson Print CD - Windows .....	233
Printing Your CD/DVD Design - Windows .....	234
Starting Epson Print CD - OS X .....	235
Printing Your CD/DVD Design - OS X.....	236

<b>Replacing Ink Cartridges .....</b>	<b>237</b>
Check Cartridge Status .....	237
Checking Cartridge Status on the LCD Screen.....	237
Checking Cartridge Status with Windows.....	238
Checking Cartridge Status with OS X.....	241
Purchase Epson Ink Cartridges.....	242
Ink Cartridge Part Numbers .....	242
Removing and Installing Ink Cartridges.....	243
Printing with Black Ink and Expended Color Cartridges .....	247
Printing with Expended Color Cartridges - Windows .....	247
Printing with Expended Color Cartridges - OS X .....	248
Conserving Low Black Ink with Windows .....	250
<b>Adjusting Print Quality.....</b>	<b>251</b>
Print Head Maintenance.....	251
Print Head Nozzle Check.....	251
Checking the Nozzles Using the Product Control Panel .....	251
Checking the Nozzles Using a Computer Utility .....	253
Print Head Cleaning .....	255
Cleaning the Print Head Using the Product Control Panel .....	256
Cleaning the Print Head Using a Computer Utility.....	257
Print Head Alignment .....	260
Aligning the Print Head Using the Product Control Panel .....	260
Aligning the Print Head Using a Computer Utility.....	261
Cleaning the Paper Path .....	263
<b>Cleaning and Transporting Your Product .....</b>	<b>264</b>
Cleaning Your Product .....	264
Transporting Your Product .....	264
<b>Solving Problems .....</b>	<b>267</b>
Checking for Software Updates.....	267
Product Status Messages .....	268
Running a Product Check .....	269
Resetting Control Panel Defaults .....	271
Solving Setup Problems .....	272

Noise After Ink Installation .....	272
Software Installation Problems .....	272
Control Panel Setup Problems .....	273
Solving Network Problems .....	273
Product Cannot Connect to a Wireless Router or Access Point .....	274
Network Software Cannot Find Product on a Network.....	275
Product Does Not Appear in OS X Printer Window.....	276
Cannot Print Over a Network.....	276
Cannot Scan Over a Network .....	277
Solving Copying Problems .....	278
Product Makes Noise, But Nothing Copies.....	279
Product Makes Noise When It Sits for a While.....	279
Solving Paper Problems.....	279
Paper Feeding Problems.....	279
Paper Jam Problems Inside the Product .....	280
Paper Jam Problems in the Paper Cassette.....	282
Paper Jam Problems in the Auto Duplexer or Rear Cover.....	282
Paper Ejection Problems .....	285
Solving Problems Printing from a Computer.....	285
Nothing Prints .....	285
Product Icon Does Not Appear in Windows Taskbar .....	286
Error After Cartridge Replacement .....	287
Printing is Slow .....	287
Solving Page Layout and Content Problems .....	288
Inverted Image.....	289
Too Many Copies Print .....	289
Blank Pages Print .....	289
Incorrect Margins on Printout.....	290
Border Appears on Borderless Prints .....	290
Incorrect Characters Print.....	291
Incorrect Image Size or Position .....	291
Slanted Printout.....	292
Solving Print Quality Problems .....	292

White or Dark Lines in Printout .....	293
Blurry or Smearred Printout .....	293
Faint Printout or Printout Has Gaps .....	295
Grainy Printout.....	296
Incorrect Colors .....	297
Solving Scanning Problems .....	297
Scanning Software Does Not Operate Correctly .....	298
Cannot Start Epson Scan .....	298
Solving Scanned Image Quality Problems .....	299
Image Consists of a Few Dots Only.....	300
Line of Dots Appears in All Scanned Images.....	300
Straight Lines in an Image Appear Crooked .....	300
Image is Distorted or Blurry .....	301
Image Colors are Patchy at the Edges .....	301
Image is Too Dark .....	301
Back of Original Image Appears in Scanned Image .....	302
Ripple Patterns Appear in an Image .....	302
Scanned Image Colors Do Not Match Original Colors.....	302
Scan Area is Not Adjustable in Thumbnail Preview .....	303
Scanned Image Edges are Cropped .....	303
Solving Memory Card Problems.....	303
Memory Card Does Not Fit Into a Slot .....	303
Cannot View or Print Photos from a Memory Card .....	304
Cannot Transfer Photos To or From a Memory Card.....	304
Uninstall Your Product Software.....	305
Uninstalling Product Software - Windows.....	305
Uninstalling Product Software - OS X .....	306
Where to Get Help.....	307
<b>Technical Specifications .....</b>	<b>308</b>
Windows System Requirements .....	308
OS X System Requirements.....	309
Scanning Specifications .....	309
Paper Specifications .....	310

Printable Area Specifications .....	311
Ink Cartridge Specifications.....	313
Memory Card Specifications .....	313
External USB Device Specifications.....	314
Dimension Specifications .....	315
Electrical Specifications .....	315
Environmental Specifications .....	316
Interface Specifications .....	316
Network Interface Specifications .....	317
Safety and Approvals Specifications .....	318
<b>Notices .....</b>	<b>319</b>
Important Safety Instructions.....	319
General Product Safety Instructions .....	319
Ink Cartridge Safety Instructions.....	321
Wireless Connection Safety Instructions .....	322
LCD Screen Safety Instructions.....	322
FCC Compliance Statement.....	322
Trademarks .....	323
Copyright Notice.....	324
A Note Concerning Responsible Use of Copyrighted Materials.....	324
Default Delay Times for Power Management for Epson Products .....	324
Copyright Attribution .....	325

---

## **XP-960 User's Guide**

Welcome to the XP-960 *User's Guide*.

For a printable PDF copy of this guide, [click here](#).

---

## Product Basics

See these sections to learn about the basic features of your product.

[Using the Control Panel](#)

[Product Parts Locations](#)

[The Power Off and Sleep Timers](#)

[Epson Connect Solutions for Smartphones, Tablets, and More](#)

[Using AirPrint](#)

[Using Google Cloud Print](#)

[Using the Mopria Print Service](#)

## Using the Control Panel

See these sections to learn about the control panel and select control panel settings.

[Control Panel Buttons and Lights](#)

[Using the LCD Screen](#)

[Adjusting Control Panel Position](#)

[Changing LCD Screen Language](#)

[Turning Off Control Panel Sounds](#)

[Turning Off Auto Selection Mode](#)





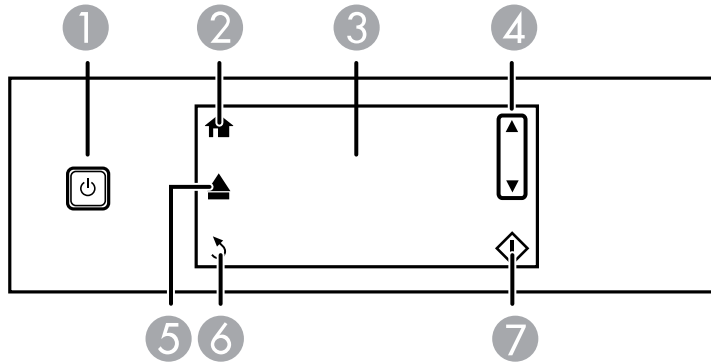

[Turning Off the Document Alert](#)

[Turning On Quiet Mode](#)

**Parent topic:** [Product Basics](#)

## Control Panel Buttons and Lights



- 1 The  power button and the  power light
- 2 The  home button
- 3 The LCD screen
- 4 The up and down arrow buttons (you can also scroll by swiping up and down on the LCD screen with your finger)
- 5 The  **Output Tray** button
- 6 The  **Back** button
- 7 The  **Start** button

Parent topic: [Using the Control Panel](#)

## Using the LCD Screen

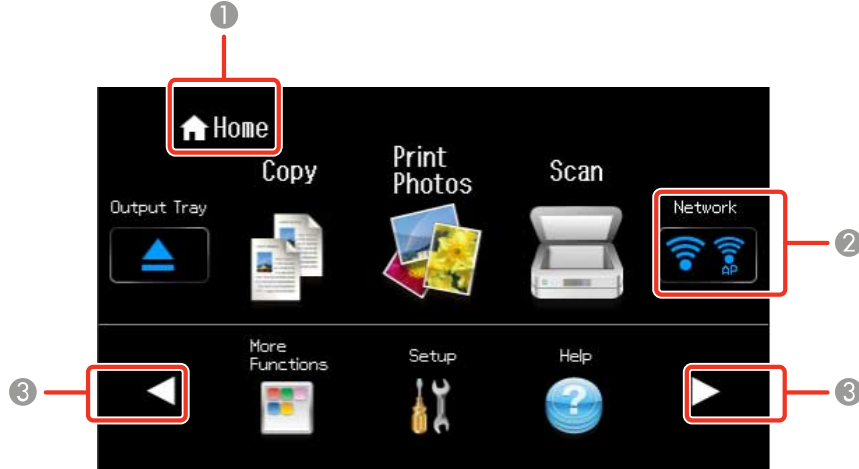

- 1 Displays the screen name
- 2 Displays network status; tap the icons to check the current status
- 3 Tap the arrows to display other features or menus

To view a list of the icons and a description of their use, select **Help > Icon List**.

**Parent topic:** [Using the Control Panel](#)

## Adjusting Control Panel Position

You can adjust the position of the control panel to make it easier to access. Raise or lower it to the desired angle as shown.

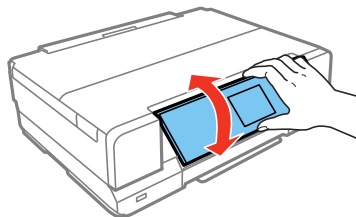



**Note:** The control panel rises and the output tray slides out automatically when printing starts.

**Parent topic:** [Using the Control Panel](#)

## Changing LCD Screen Language



You can change the language used on the LCD screen.

1. Press the  home button, if necessary.
2. Select **Setup**.
3. Scroll down and select **Basic Setup**.
4. Select **Language**.
5. Select a language.
6. Press the  home button to exit.

**Parent topic:** [Using the Control Panel](#)

## Turning Off Control Panel Sounds

You can turn off the sound heard when you press buttons on the control panel.

1. Press the  home button, if necessary.
2. Select **Setup**.
3. Select **Printer Setup**.
4. Select **Sound**.
5. Select **Button Press**.
6. Select the **Off** setting.
7. Press the  home button to exit.

**Parent topic:** [Using the Control Panel](#)

## Turning Off Auto Selection Mode

Auto Selection Mode changes the menu options on the LCD screen automatically depending on the action you perform. For instance, loading a memory card displays memory card-related menu options on the screen. You can turn off this feature from the control panel.

1. Press the  home button, if necessary.

2. Select **Setup**.
3. Select **Guide Functions**.
4. Select **Auto Selection Mode**.
5. Turn off the desired options displayed on the screen.
6. Press the 🏠 home button to exit.

**Parent topic:** [Using the Control Panel](#)

## Turning Off the Document Alert

The Document Alert warns you that an original has been left on the scanner glass. You can turn off this feature from the product's control panel.

1. Press the 🏠 home button, if necessary.
2. Select **Setup**.
3. Scroll down and select **Guide Functions**.

You see this screen:

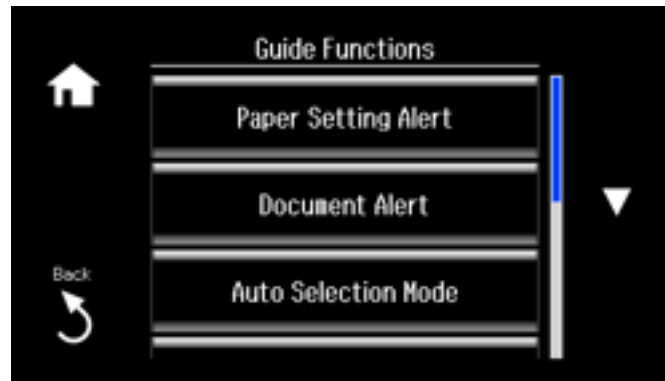



4. Select **Document Alert**.
5. Select **Off**.
6. Press the 🏠 home button to exit.

**Parent topic:** [Using the Control Panel](#)

## Turning On Quiet Mode

You can reduce the noise the product makes by turning on the Quiet Mode option.

**Note:** Turning on this setting may reduce print speed.

1. Press the  home button, if necessary.
2. Select **Setup**.
3. Select **Printer Setup**.
4. Select **Quiet Mode**.
5. Select the **On** setting.
6. Press the  home button to exit.

**Parent topic:** [Using the Control Panel](#)

## Product Parts Locations

See these sections to identify the parts on your product.

[Product Parts - Top](#)

[Product Parts - Front](#)

[Product Parts - Inside](#)

[Product Parts - Back](#)

**Parent topic:** [Product Basics](#)

## Product Parts - Top

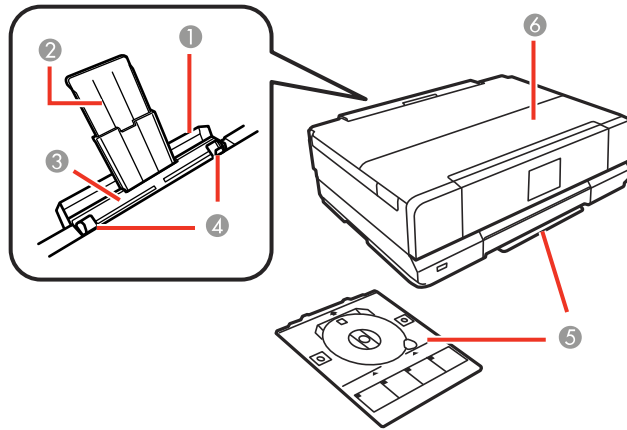

- 1 Rear paper feed slot cover
- 2 Paper support and extension
- 3 Rear paper feed slot
- 4 Edge guides
- 5 CD/DVD tray (shown removed and in storage position)
- 6 Document cover

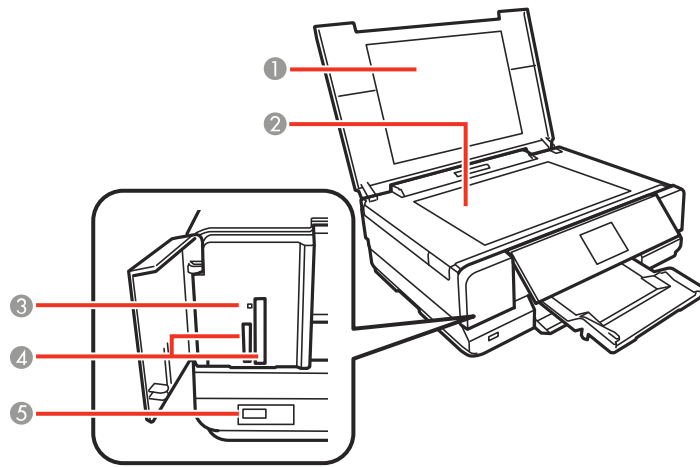

- 1 Document cover
- 2 Scanner glass
- 3 Memory card access light
- 4 Memory card slots
- 5  USB Type A port for external devices

**Parent topic:** [Product Parts Locations](#)

## Product Parts - Front

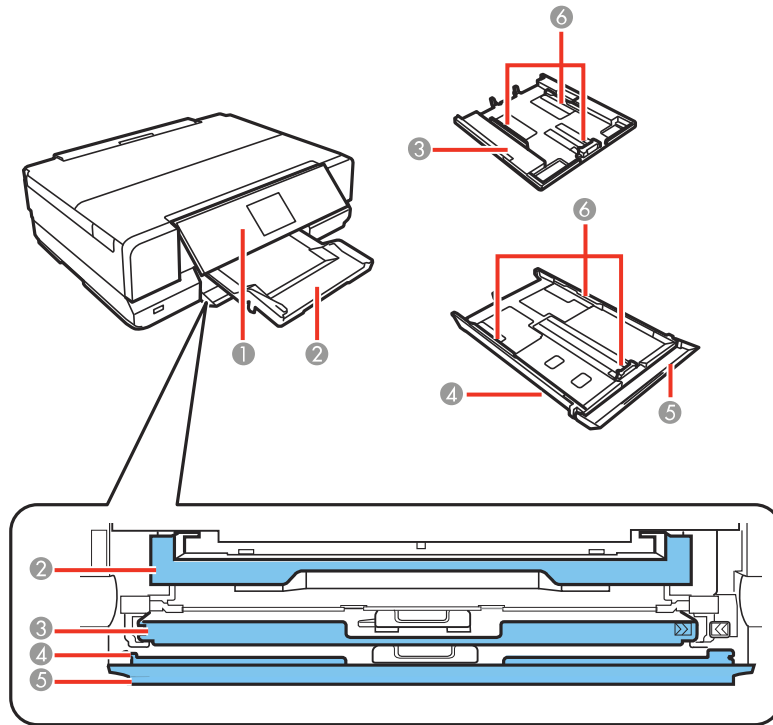

- 1 Control panel
- 2 Output tray
- 3 Cassette 1 (upper cassette)
- 4 Cassette 2 (lower cassette)
- 5 Front cover (attached to Cassette 2)
- 6 Cassette edge guides

Parent topic: [Product Parts Locations](#)

## Product Parts - Inside

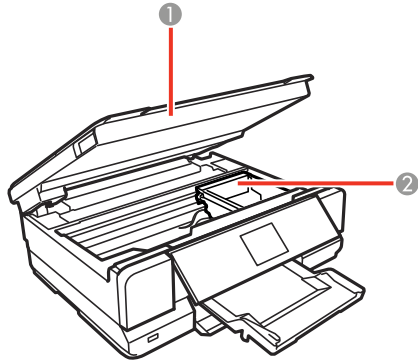

- 1 Scanner unit
- 2 Print head/ink cartridge holder

Parent topic: [Product Parts Locations](#)

## Product Parts - Back

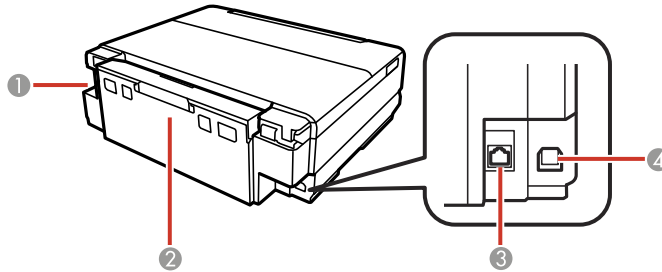

- 1 AC inlet
- 2 Rear cover
- 3 **LAN** port
- 4 **USB** port

Parent topic: [Product Parts Locations](#)

## The Power Off and Sleep Timers

The product enters sleep mode or turns off automatically if it is not used for a period of time. You can adjust the time period before power management, but increasing the time reduces the product's energy efficiency.

[Changing the Power Off Timer Setting From the Control Panel](#)

[Changing the Sleep Timer Setting From the Control Panel](#)

[Changing the Power and Sleep Timer Settings - Windows](#)

[Changing the Power and Sleep Timer Settings - OS X](#)

Parent topic: [Product Basics](#)

### Changing the Power Off Timer Setting From the Control Panel

You can use the product's control panel to change the time period before the printer turns off automatically.

1. Press the  home button, if necessary.
2. Select **Setup**.
3. Select **Printer Setup**.

You see this screen:



4. Press the up or down arrow button to select **Power Off Timer**.

You see this screen:

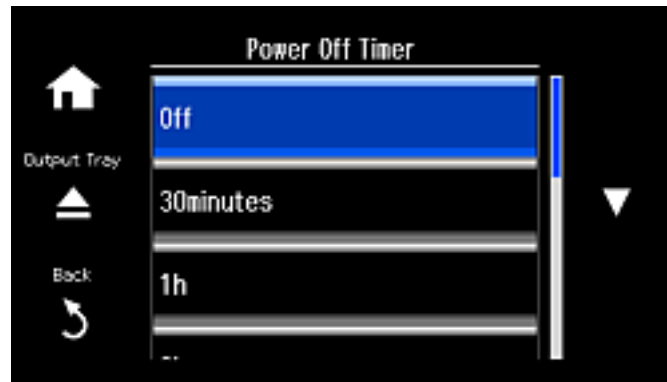

5. Press the up or down arrow button to select the length of time after which you want the product to automatically turn off when it is not in use.
6. Press the  home button to exit.

**Parent topic:** [The Power Off and Sleep Timers](#)

## Changing the Sleep Timer Setting From the Control Panel

You can use the product's control panel to change the time period before the product enters sleep mode.

1. Press the  home button, if necessary.
2. Select **Setup**.
3. Select **Printer Setup**.

You see this screen:



4. Press the up or down arrow button to select **Sleep Timer**.

You see this screen:



5. Press the up or down arrow button to select the time period you want before the product goes to sleep.
6. Press the  home button to exit.

**Parent topic:** [The Power Off and Sleep Timers](#)

## Changing the Power and Sleep Timer Settings - Windows

You can use the printer software to change the time period before the product enters sleep mode or turns off automatically.

1. Make sure your product is turned on.
2. Access the Windows Desktop and right-click the product icon in the Windows taskbar.
3. Select **Printer Settings**.
4. Click the **Maintenance** tab.
5. Click the **Printer and Option Information** button.

You see this screen:

Printer and Option Information

Power Off Timer  
Current Printer Setting : Off  
Off Send

Sleep Timer  
Current Printer Setting : 10 minutes  
10 minutes Send

Printer ID  
ID 221 Settings Sheet

Option information has already been stored. Therefore, you do not need to enter any information.

Check paper width before printing  
 Thick paper and envelopes

OK Cancel Help

6. Select the length of time after which you want the product to automatically turn off when it is not in use as the **Power Off Timer** setting.

7. Click **Send**.
8. Select the time period you want before the product goes to sleep as the **Sleep Timer** setting.
9. Click **Send**.
10. Click **OK** to close the open program windows.

Parent topic: [The Power Off and Sleep Timers](#)

## Changing the Power and Sleep Timer Settings - OS X

You can use the printer software to change the time period before the product enters sleep mode or turns off automatically.

1. Make sure your product is turned on.
2. In the Apple menu or the Dock, select **System Preferences**. Select **Print & Fax**, **Print & Scan**, or **Printers & Scanners**, select your product, and select **Options & Supplies**. Select **Utility** and select **Open Printer Utility**.
3. Select **Printer Settings**.

You see this window:

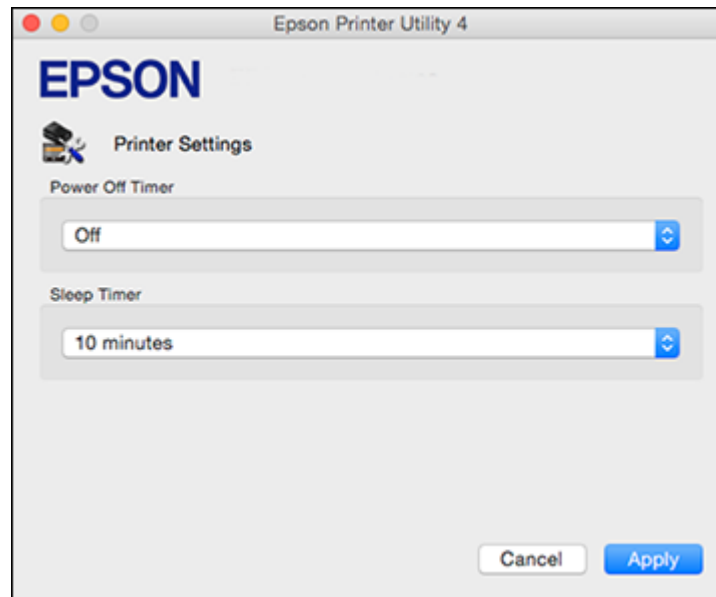

4. Select the length of time after which you want the product to automatically turn off when it is not in use as the **Power Off Timer** setting.
5. Select the time period you want before the product goes to sleep as the **Sleep Timer** setting.
6. Click **Apply**.
7. Close the Printer Settings window.

**Parent topic:** [The Power Off and Sleep Timers](#)

## Epson Connect Solutions for Smartphones, Tablets, and More

You can print documents, photos, emails, and web pages from your home, office, or even across the globe. You can use your smartphone, tablet, or computer. Epson offers these solutions to print from anywhere: Epson Email Print, Epson iPrint Mobile App, Epson Remote Print, and Epson Scan to Cloud.

[Using Epson Email Print](#)

[Using the Epson iPrint Mobile App](#)

[Using Epson Remote Print](#)

[Using Epson Scan to Cloud](#)

**Parent topic:** [Product Basics](#)

## Using Epson Email Print

With Epson Email Print, you can print from any device that can send email, such as your smartphone, tablet, or laptop. Just activate your product's unique email address. When you want to print, attach a PDF, Microsoft Office document, or photo to an email and send it to your product.

1. Set up your product for network printing. See the link below.
2. If you did not already set up Email Print when you installed your product software, visit [epson.com/connect](http://epson.com/connect) to learn more about Email Print, check compatibility, and get detailed setup instructions.
3. Send an email with attachments to your product's Email Print address.

**Note:** Both the email and any attachments print by default. You can change these printing options by logging into your Epson Connect account.

**Parent topic:** [Epson Connect Solutions for Smartphones, Tablets, and More](#)

### Related topics

[Wi-Fi or Wired Networking](#)

## Using the Epson iPrint Mobile App

Use this free Apple and Android app to print to nearby Epson networked products. The Epson iPrint Mobile App lets you print PDFs, Microsoft Office documents, photos, and web pages over a wireless network. You can even scan and save a file on your device, send it as an email, or upload it to an online service such as Box, Dropbox, Evernote, or Google Drive.

1. Set up your product on a network. See the link below.
2. Visit [epson.com/connect](http://epson.com/connect) to learn more about Epson iPrint and check the compatibility of your mobile device.
3. Download Epson iPrint from the Apple App Store or Google Play.
4. Connect your mobile device to the same wireless network that your product is using.
5. Print from your mobile device to your Epson product.

**Parent topic:** [Epson Connect Solutions for Smartphones, Tablets, and More](#)

### Related topics

[Wi-Fi or Wired Networking](#)

## Using Epson Remote Print

With Epson Remote Print software, you can print to an Epson Email-enabled product anywhere in the world.

1. Set up your product for network printing. See the link below.
2. Visit [epson.com/connect](http://epson.com/connect) to learn more about Remote Print and how to download the software.
3. Download and install the Remote Print software.
4. Obtain the email address and optional access key of the Epson product you want to use for printing, and enter this address during Remote Print setup.
5. Select the print command in your application and choose the Remote Print driver for your Epson product.

**Parent topic:** [Epson Connect Solutions for Smartphones, Tablets, and More](#)

### Related topics

[Wi-Fi or Wired Networking](#)

## Using Epson Scan to Cloud

The Epson Scan to Cloud service sends your scanned files to a destination that you have registered with Epson Connect.

1. Set up your product for network scanning. See the link below.
2. Visit [epson.com/connect](https://epson.com/connect) for instructions on registering an account and your product with Epson Connect.
3. After registering, sign in to the Epson Connect web page with the email address and password you selected.
4. Select **Destination List** for Scan to Cloud.
5. Click **Add**, then follow the instructions on the screen to create your destination list.
6. When you're ready to scan, select the setting for the Scan to Cloud service on your product control panel.

**Parent topic:** [Epson Connect Solutions for Smartphones, Tablets, and More](#)

**Related topics**

[Wi-Fi or Wired Networking](#)

## Using AirPrint

AirPrint enables instant wireless printing from iPhone, iPad, and iPod touch with the latest version of iOS, and Mac with the latest version of OS X.



**Note:** If you disabled paper configuration messages on your product control panel, you cannot use AirPrint. See the link below to enable the messages, if necessary.

1. Load paper in your product.
2. Set up your product for wireless printing. See the link below.
3. Connect your Apple device to the same wireless network that your product is using.
4. Print from your device to your product.

**Note:** For details, see the AirPrint page on the Apple website.

**Parent topic:** [Product Basics](#)

## Related topics

[Wi-Fi or Wired Networking](#)

# Using Google Cloud Print

With a Google Account, you can print from your Apple or Android device to your Epson product. You can also print from Chromebooks and the Google Chrome browser without drivers or cables.

Set up your Epson product for network printing. See the link below.

**Note:** Make sure your Epson printer and computer are connected to the same network before starting the Google Cloud Print setup.

1. Connect your device to the same network that your Epson product is using.
2. Print a network status sheet.
3. Locate your product's IP address on the network status sheet.
4. Enter the IP address into the address bar of a web browser.
5. Select the **Google Cloud Print Services** option.

**Note:** If you don't see the **Google Cloud Print Services** option, turn your product off and back on. If the option still doesn't appear, select the **Firmware Update** option and follow the on-screen instructions to update your product.

6. Click **Register**.
7. Select the checkbox to agree to the Usage Advisory and click **Next**.
8. Click **OK** to launch the sign-in page.  
A separate browser window opens.
9. Enter your Google Account username and password and click **Sign in**, or, if you don't have an account, click **Sign up for a new Google Account** and follow the on-screen instructions.
10. Click **Finish printer registration** to complete setup and print a test page.

Your product is now linked to your Google Account and can be accessed from any Chromebook, computer, Apple or Android device with Internet access. Visit [Epson Support](#) for more information on using Google Cloud Print, or the [Google Cloud Print](#) website for a list of [supported apps](#).

[Setting Up Google Cloud Print on a Chromebook](#)

**Parent topic:** [Product Basics](#)

### Related tasks

[Printing a Network Status Sheet](#)  
[Accessing the Web Config Utility](#)

### Related topics

[Wi-Fi or Wired Networking](#)

## Setting Up Google Cloud Print on a Chromebook

With a Google Account, you can print from a Chromebook without drivers or cables.

Set up your Epson product for network printing. See the link below.

**Note:** Make sure your Epson product is connected to your wireless network before starting the Google Cloud Print setup.

1. Turn on your Chromebook and connect it to the same wireless network as your product.

**Note:** See your Chromebook's documentation for details on connecting to a network.

2. Do one of the following:

- Click **Add to Cloud Print** in the notification that appears in the corner of your Chromebook screen.

**Note:** If you do not see a notification, check to see if a number appears in the status area at the lower-right corner of the screen. Click this number to open the notifications menu, then click **Add to Cloud Print**.

- Open a web browser and enter **chrome://devices** in the address bar. Skip to step 4.
- If you see a registration confirmation screen instead, click **Register**.

3. Click **Add Device**.
4. Click the **Register** button that appears next to your product.
5. Click **Register** on the confirmation screen. Your product's LCD screen displays a confirmation message.
6. Select **OK** or press the **OK** button on your product to confirm the Google Cloud Print connection and print a test page.

Your product is now linked to your Google Account and can be accessed from any Chromebook, iPhone, or Android phone with Internet access. For more information on using Google Cloud Print, visit [Epson Support](#).

**Parent topic:** [Using Google Cloud Print](#)

**Related topics**

[Wi-Fi or Wired Networking](#)

## Using the Mopria Print Service

You can use the Mopria Print Service to print from your Android phone or tablet (Android v4.4 or later) to your Epson product or any Mopria-certified product from other manufacturers. You can download the Mopria Print Service from Google Play.

**Note:** For details on the Mopria Print Service, [click here](#) .

**Parent topic:** [Product Basics](#)

---

# Wi-Fi or Wired Networking

See these sections to use your product on a Wi-Fi or wired network.

[Wi-Fi Infrastructure Mode Setup](#)

[Wi-Fi Direct Mode Setup](#)

[Wi-Fi Protected Setup \(WPS\)](#)

[Wired Network Setup](#)

[Printing a Network Status Sheet](#)

[Changing or Updating Network Connections](#)

## Wi-Fi Infrastructure Mode Setup

You can set up your product to communicate with your computer using a wireless router or access point. The wireless router or access point can be connected to your computer over a wireless or wired network.

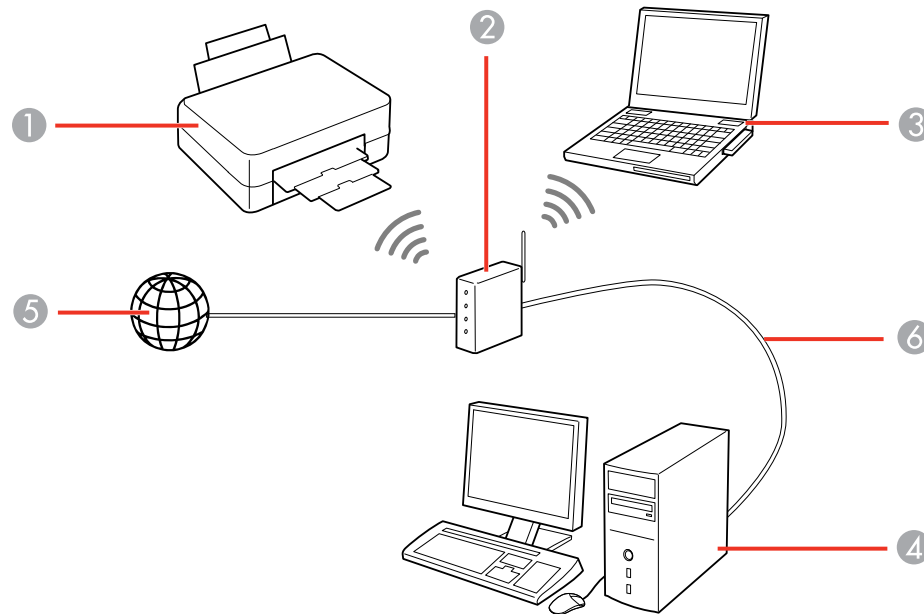

1 Epson product

- 2 Wireless router or access point
- 3 Computer with a wireless interface
- 4 Computer
- 5 Internet
- 6 Ethernet cable (used only for wired connection to the wireless router or access point)

### Selecting Wireless Network Settings From the Control Panel

Parent topic: [Wi-Fi or Wired Networking](#)

## Selecting Wireless Network Settings From the Control Panel

You can select or change wireless network settings using your product control panel.

To install your product on a wireless network, follow the instructions on the *Start Here* sheet and install the necessary software from the product CD. The installer program guides you through network setup.

**Note:** Breakdown or repair of this product may cause loss of network data and settings. Epson is not responsible for backing up or recovering data and settings during or after the warranty period. We recommend that you make your own backup or print out your network data and settings.

1. Press the  home button, if necessary.
2. Select **Setup**.
3. Select **Network Settings**.
4. Select **Wi-Fi Setup**.

You see this screen:



5. Select **Wi-Fi Setup Wizard**.

**Note:** If you need to disable the wireless network to set up your product on an Ethernet network, scroll down and select **Disable Wi-Fi** instead. Then follow the instructions on changing to a wired network connection in this guide.



6. Select the name of your wireless network or enter the name manually.

**Note:** To enter the wireless network name manually, scroll down and then select **Other Networks**. Use the displayed keypad to enter your network name, as described in the next step.

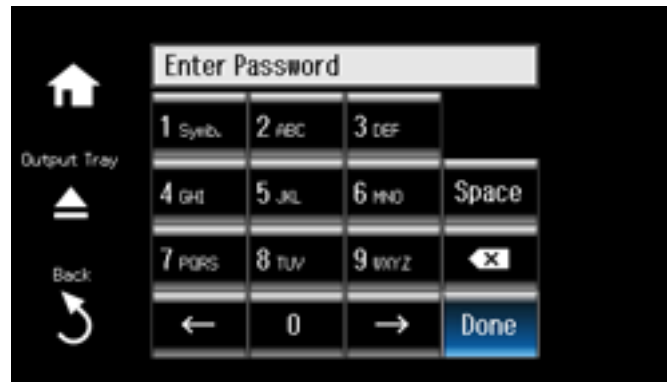
7. Enter your wireless password (or network name and then password) using the displayed keypad.



**Note:** The network name and password are case sensitive. Be sure to correctly enter uppercase and lowercase letters, and numeric or special characters.

- Press the touch screen buttons repeatedly to scroll through characters.
  - Press  or  to move the cursor.
  - Press **1 Symb.** to enter symbols.
  - Press  to delete the previous character.
8. Press **Done** when you finish entering your password.
  9. Confirm the displayed network settings and select **Proceed** to save them.

**Note:** If you need to change a setting, press the  **Back** button.

10. If you want to print a network setup report, press the  **Start** button. (Otherwise, select **Done**.)

If the network connection is successful, a Wi-Fi antenna icon with blue connection bars is displayed in the **Network** area on the right-hand side of the LCD screen.



Parent topic: [Wi-Fi Infrastructure Mode Setup](#)

Related tasks

[Changing a Wi-Fi Connection to a Wired Network Connection](#)

## Wi-Fi Direct Mode Setup

You can set up your product to communicate directly with your computer or another device without requiring a wireless router or access point.

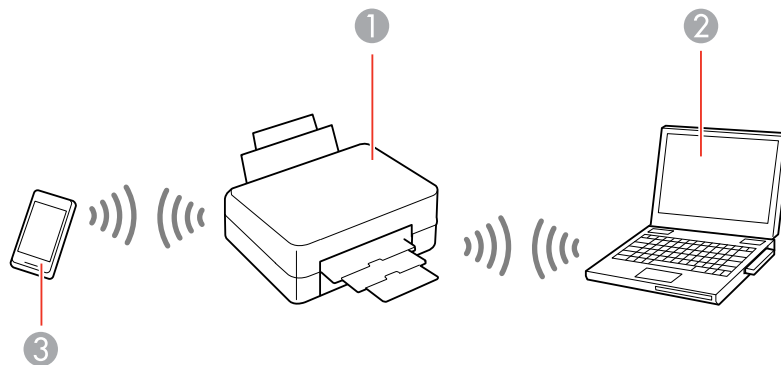

- 1 Epson product
- 2 Computer with a wireless interface
- 3 Other wireless device

You can select one of these modes to communicate with your computer or device:

#### **Access point mode**

The product itself acts as the network access point for up to 4 devices. When operating in this mode, your product displays an **AP** connection symbol on the LCD screen.

#### **Peer-to-peer mode**

The product communicates one-to-one with another Wi-Fi Direct capable device. When operating in this mode, your product displays a **Direct** or **D** connection symbol on the LCD screen.

To disconnect a peer-to-peer mode connection, release the connection to your product from your computer or other device.

To enable peer-to-peer mode, you must select it from the Web Config Utility, under **WiFi/Network Settings > Services > Wi-Fi Direct**.

[Enabling Wi-Fi Direct Mode](#)

**Parent topic:** [Wi-Fi or Wired Networking](#)

## **Enabling Wi-Fi Direct Mode**

You can enable Wi-Fi Direct mode to allow direct communication between your product and computer or other devices without a wireless router or access point.

1. Press the  home button, if necessary.
2. Select **Setup**.
3. Select **Network Settings**.
4. Select **Wi-Fi Setup**.
5. Select **Wi-Fi Direct Setup**.

You see this screen:



6. Select **Connection Setup**.
7. Select **Change Password** and select **OK**.

**Note:** If you have already connected devices or computers to your product via Wi-Fi Direct, they will be disconnected when you change the password.

8. Enter your Wi-Fi Direct password.

**Note:** Your password must be at least 8 and no more than 22 characters long.

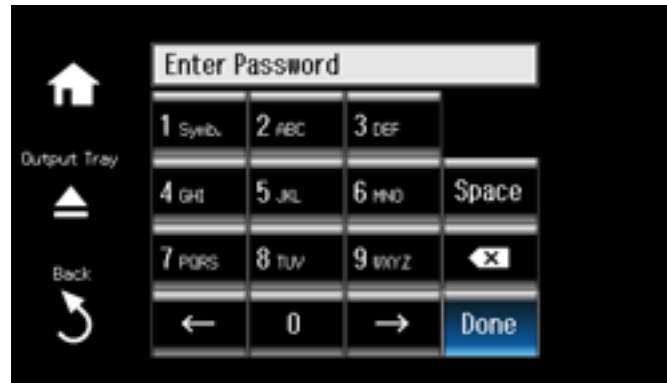

- Press the touch screen buttons repeatedly to scroll through characters.
- Press **←** or **→** to move the cursor.
- Press **1 Symb.** to enter symbols.
- Press **X** to delete the previous character.

9. Press **Done** when you finish entering your password.

You see this screen:

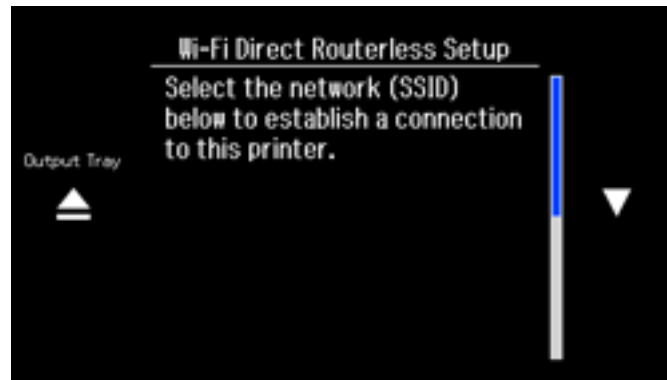

10. Scroll down to view the SSID (Wi-Fi network name) and password.
11. Use your computer or wireless device to select the Wi-Fi network name (SSID) displayed on the LCD screen, then enter the password shown.
12. Press the  home button to exit.  
You see either an **AP** or **Direct** Wi-Fi symbol on the LCD screen and should be able to print directly to your product from your computer or device.

**Note:** If the **AP** or **Direct** Wi-Fi symbol is not displayed on the LCD screen, Wi-Fi Direct mode is not enabled. Repeat these steps to try again.

**Parent topic:** [Wi-Fi Direct Mode Setup](#)

## Wi-Fi Protected Setup (WPS)

If your network uses a WPS-enabled wireless router or access point, you can quickly connect your product to the network using Wi-Fi Protected Setup (WPS).

**Note:** To check if your router is WPS-enabled, look for a button labeled **WPS** on your router or access point. If there is no hardware button, there may be a virtual WPS button in the software for the device. Check your network product documentation for details.

[Using WPS to Connect to a Network](#)

**Parent topic:** [Wi-Fi or Wired Networking](#)

## Using WPS to Connect to a Network

If you have a WPS-enabled wireless router or access point, you can use Wi-Fi Protected Setup (WPS) to connect your product to the network.

1. Press the  home button, if necessary.
2. Select **Setup**.
3. Select **Network Settings**.
4. Select **Wi-Fi Setup**.

You see this screen:



5. Select **Push Button Setup (WPS)**.
6. Follow the instructions on the LCD screen to complete WPS setup.
7. Select **OK** if necessary.

If the network connection is successful, the **Network** icon on the right side of the LCD screen is blue as shown:



Parent topic: [Wi-Fi Protected Setup \(WPS\)](#)

## Wired Network Setup

You can set up your product to communicate with your computer over a wired network by connecting it to the router or hub using an Ethernet cable.

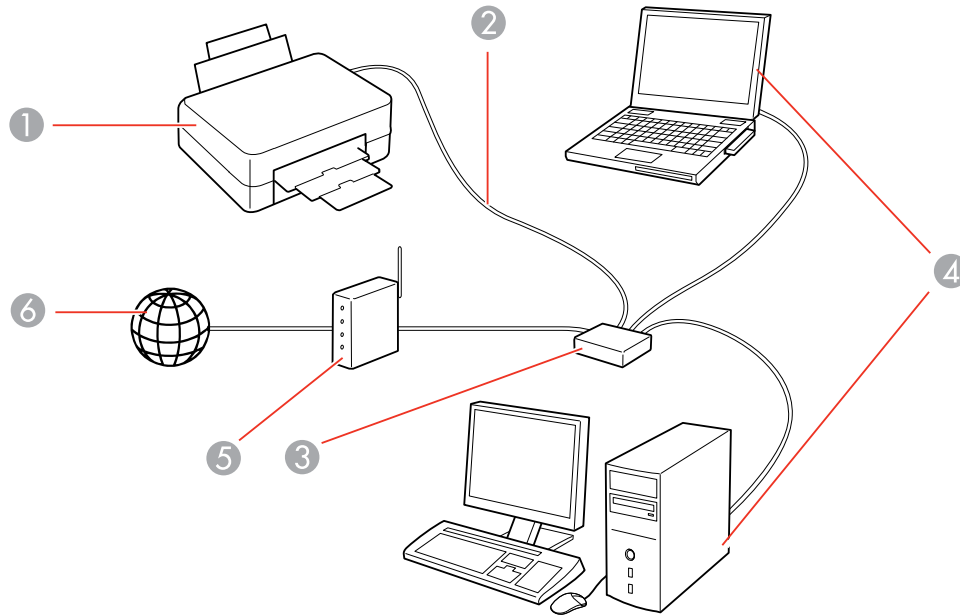



- 1 Epson product
- 2 Ethernet cable
- 3 Ethernet hub
- 4 Computers with a wired network interfaces
- 5 Router
- 6 Internet

Parent topic: [Wi-Fi or Wired Networking](#)

## Printing a Network Status Sheet

You can print a network status sheet to help you determine the causes of any problems you may have using your product on a network.

1. Press the  home button, if necessary.
2. Select **Network**.
3. Select **See Connection Details**.
4. Select **Details**.
5. Scroll down and select **Print Status Sheet**.
6. Press the  **Start** button to print the network status sheet.

(Select **Cancel** if you want to cancel the operation.)

Examine the settings shown on the network status sheet to diagnose any problems you have.

**Parent topic:** [Wi-Fi or Wired Networking](#)

## Changing or Updating Network Connections

See these sections to change or update how your product connects to a network.

[Accessing the Web Config Utility](#)

[Changing a USB Connection to a Wi-Fi Connection](#)

[Changing a Wi-Fi Connection to a Wired Network Connection](#)

[Connecting to a New Wi-Fi Router](#)

[Disabling Wi-Fi Features](#)

**Parent topic:** [Wi-Fi or Wired Networking](#)

### Related tasks

[Printing a Network Status Sheet](#)

[Accessing the Web Config Utility](#)

## Accessing the Web Config Utility

You can select your product's network settings and confirm its operating status using a web browser. You do this by accessing your product's built-in Web Config utility from a computer or other device that is connected to the same network as your product.

1. Print a network status sheet.
2. Locate the IP Address for your product that is listed on the network status sheet.

3. On a computer or other device connected to the same network as your product, open a web browser.
4. Enter your product's IP address into the address bar.  
You see the available Web Config utility options.

**Parent topic:** [Changing or Updating Network Connections](#)

## Changing a USB Connection to a Wi-Fi Connection

If you have already connected your product to your computer using a USB connection, you can change to a Wi-Fi connection.

1. Disconnect the USB cable from your product.
2. Uninstall your product software.
3. Download and install your product software from the Epson website using the instructions on the *Start Here* sheet.

**Parent topic:** [Changing or Updating Network Connections](#)

## Changing a Wi-Fi Connection to a Wired Network Connection

If you have already connected your product to your computer wirelessly, you can change to a wired network connection if necessary.

1. Disable your product's Wi-Fi features.
2. Connect one end of an Ethernet network cable to the product's **LAN** port.
3. Connect the other end to any available LAN port on your router or access point.
4. Uninstall your product software.
5. Download and install your product software from the Epson website.
6. Follow the on-screen instructions to install the software.
7. When you see the Select Your Connection screen, select **Wired network connection**.
8. If you see a Select Setup Option screen, select **Set up printer for the first time**.
9. Continue following the rest of the on-screen instructions.

**Parent topic:** [Changing or Updating Network Connections](#)

## Connecting to a New Wi-Fi Router

If you change the wireless router you have been using on your network, you need to update your product's Wi-Fi connection to the new router.

**Note:** If you switch to a 5 GHz wireless router, set the router to operate in dual band (2.4 GHz and 5 GHz) mode. See your router documentation for instructions.

1. Do one of the following:
  - **Windows:** Uninstall your product software.
  - **OS X:** Go to the next step.
2. Download and install your product software from the Epson website using the instructions on the *Start Here* sheet.

**Parent topic:** [Changing or Updating Network Connections](#)

## Disabling Wi-Fi Features

You may need to disable your product's Wi-Fi features if you change your network connection type or need to solve a problem with your network connection.

**Note:** Before disabling Wi-Fi features, make a note of your product's SSID (network name) and password, and any network settings selected for the Epson Connect services you may use.

1. Press the  home button, if necessary.
2. Select **Setup**.
3. Select **Network Settings**.
4. Select **Wi-Fi Setup**.

You see this screen:



5. Scroll down and select **Disable Wi-Fi**.

6. Select **Yes** to disable Wi-Fi.

**Parent topic:** [Changing or Updating Network Connections](#)

---

# Loading Paper

Before you print, load paper for the type of printing you will do.

[Loading Paper in Cassette 1 \(Upper Cassette\)](#)

[Loading Paper in Cassette 2 \(Lower Cassette\)](#)

[Loading Paper in the Rear Paper Feed Slot](#)

[Loading Envelopes](#)

[Selecting the Paper Settings for Each Source - Control Panel](#)

[Printing on Thick Paper](#)

[Turning Off the Paper Setting Alert](#)

[Paper Loading Capacity](#)

[Available Epson Papers](#)

[Borderless Paper Type Compatibility](#)

[Paper or Media Type Settings - Control Panel](#)

[Paper or Media Type Settings - Printer Software](#)

## Loading Paper in Cassette 1 (Upper Cassette)

You can load photo paper and other media in these sizes in the upper paper cassette:

- 4 × 6 inches (102 × 152 mm)
- 5 × 7 inches (127 × 178 mm)

**Note:** Do not remove or insert the paper cassette during operation.

1. Close the output tray by pressing the  **Output Tray** button on the LCD screen or by hand, if necessary.

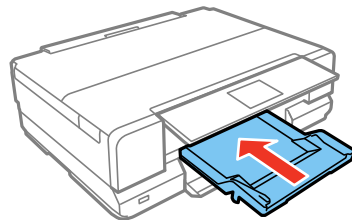

**Note:** If you slide in the output tray by hand, there may be slight resistance and noise. This is normal.

2. Open the front cover.

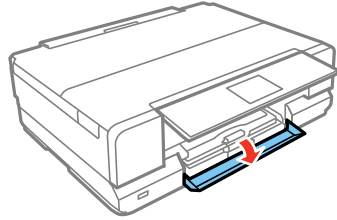

3. Pull out the upper paper cassette. (The upper cassette has a ► label on the right side.)

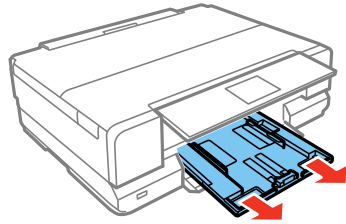

**Note:** If the cassette is too far inside the product to reach, turn the product off and on again.

4. Slide the edge guides outward.

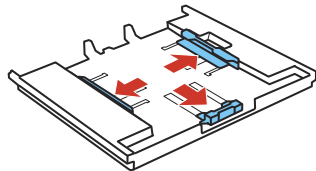

5. Set the front edge guide to the position for the paper size you are using.

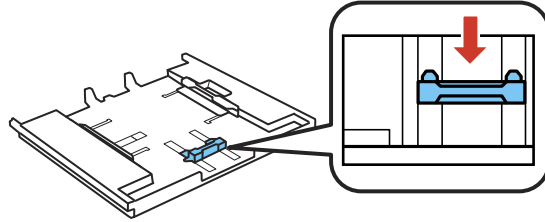

**Note:** Various paper sizes are marked on the tray.

6. Insert paper with the glossy or printable side facedown.

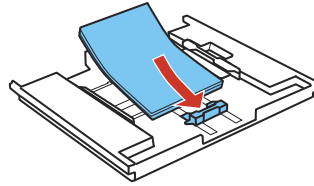

**Note:** Make sure the paper is loaded against the front edge guide and not sticking out from the end of the cassette.

7. Slide the side edge guides against the paper, but not too tightly.

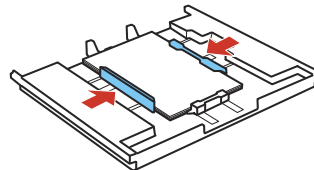

**Note:** Make sure the paper is under the tabs on the edge guides.

8. Keep the cassette flat as you insert it until the left and right arrow marks on the tray and product line up.

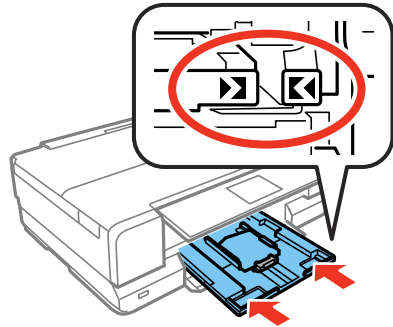

**Note:** The output tray opens automatically when you print. Leave enough space in front of the product for the paper to be fully ejected. Do not remove or insert the paper cassette while the product is operating.

9. If prompted by the product's LCD screen, select the size and type of the paper you loaded, and select **Done**.

Always follow these paper loading guidelines:

- Load only the recommended number of sheets.
- Load paper short edge first and printable side facedown.
- Make sure the paper is under the tabs on the edge guides and not sticking out from the end of the cassette.
- Check the paper package for any additional loading instructions.

**Parent topic:** [Loading Paper](#)

#### **Related references**

[Paper Loading Capacity](#)

[Paper or Media Type Settings - Printer Software](#)

[Paper or Media Type Settings - Control Panel](#)

#### **Related tasks**

[Selecting the Paper Settings for Each Source - Control Panel](#)

[Loading Paper in Cassette 2 \(Lower Cassette\)](#)

## Loading Paper in Cassette 2 (Lower Cassette)

You can load paper up to this size in the lower paper cassette: Legal (8.5 × 14 inches [216 × 356 mm]).

**Note:** Do not remove or insert the paper cassette while the product is operating.

1. Close the output tray by pressing the ▲ **Output Tray** button or by hand, if necessary.

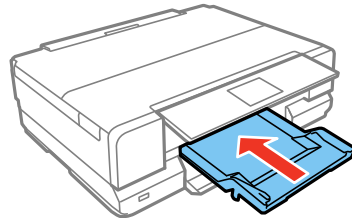

**Note:** As you slide in the output tray, there may be slight resistance and noise. This is normal.

2. Open the front cover.

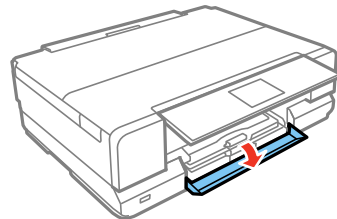

3. Pull on the front cover to remove the lower paper cassette.

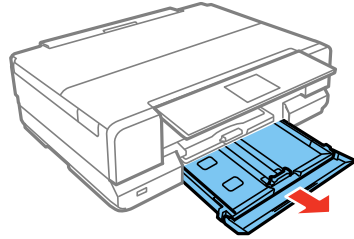

4. Slide the edge guides outward.

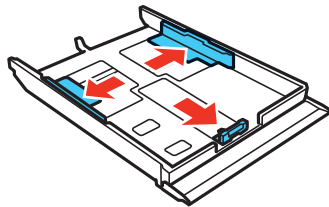

**Note:** If you are using legal-size paper, remove the CD/DVD tray from under the lower cassette. Press the button on the lower cassette and extend it as shown.

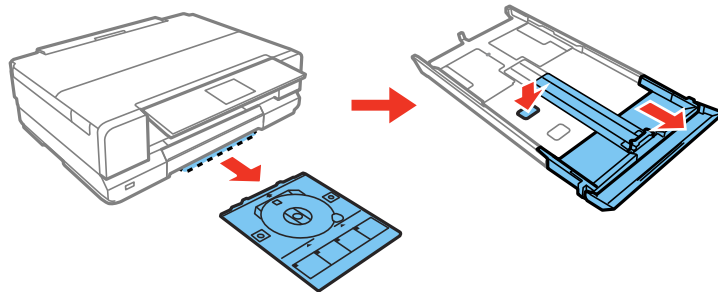

5. Set the front edge guide to the paper size you are using.

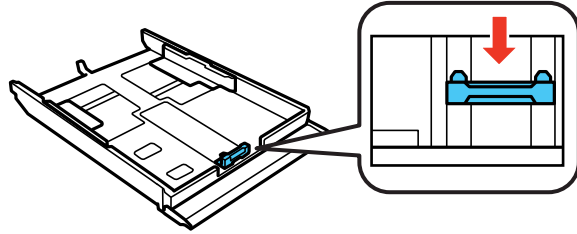

**Note:** Various paper sizes are marked on the tray.

6. Insert paper with the glossy or printable side down.

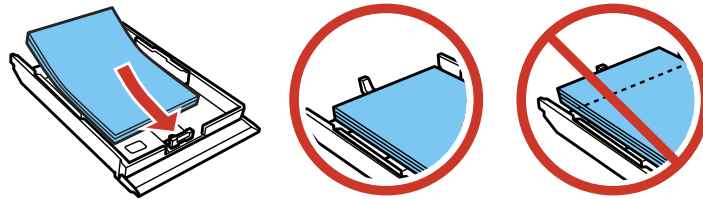

**Note:** Make sure the paper is loaded against the front edge guide and not sticking out from the end of the cassette.

- Slide the side edge guides against the paper, but not too tightly.

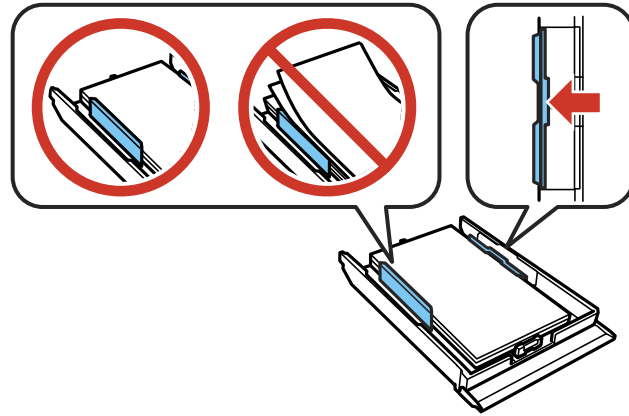

**Note:** Make sure the paper is under the tabs on the edge guides.

- Keep the cassette flat as you insert it.

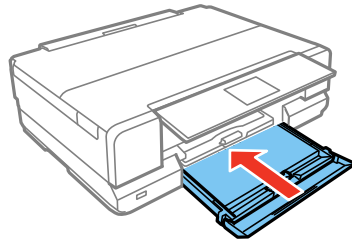

**Note:** The output tray opens automatically when you print. Leave enough space in front of the product for the paper to be fully ejected. Do not remove or insert the paper cassette while the product is operating.

- If prompted by the product's LCD screen, select the size and type of the paper you loaded, and select **Done**.

Always follow these paper loading guidelines:

- Load only the recommended number of sheets.

- Load paper short edge first and printable side facedown.
- Make sure the paper is under the tabs on the edge guides and not sticking out from the end of the cassette.
- Check the paper package for any additional loading instructions.

**Parent topic:** [Loading Paper](#)

**Related references**

[Paper Loading Capacity](#)

[Paper or Media Type Settings - Printer Software](#)

[Paper or Media Type Settings - Control Panel](#)

**Related tasks**

[Selecting the Paper Settings for Each Source - Control Panel](#)

[Loading Paper in Cassette 1 \(Upper Cassette\)](#)

[Loading Paper in the Rear Paper Feed Slot](#)

[Loading Envelopes](#)

## Loading Paper in the Rear Paper Feed Slot

You can load one sheet of paper, card stock, other thick media, or one envelope in the rear paper feed slot. You can load paper up to 11 × 17 inches (279 × 432 mm) / A3 (11.7 × 16.5 inches [297 × 420 mm]).

**Note:** Paper that is too stiff may not load correctly even if it is within the paper specifications.

1. Send your print job from a computer or using the product's touch screen.
  - If printing from a computer, select **Rear Paper Feed Slot** for the **Source** (Windows) or **Paper Source** (OS X) setting.
  - If printing from the product's touch screen, select **Rear Paper Feed Slot** for the **Paper Source** setting.

2. Flip open the rear paper feed slot cover.

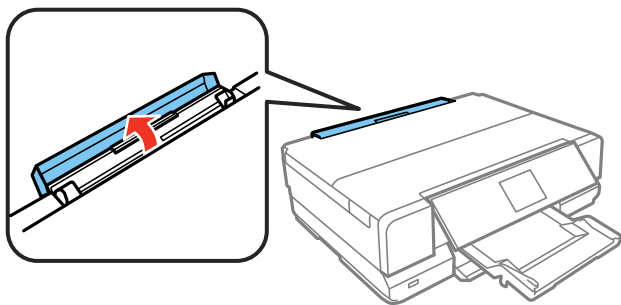

3. Fully extend the paper support and tilt it back, as shown.

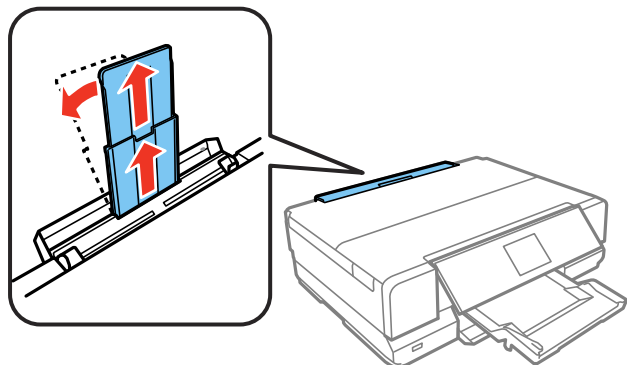

4. Slide the edge guides outward.

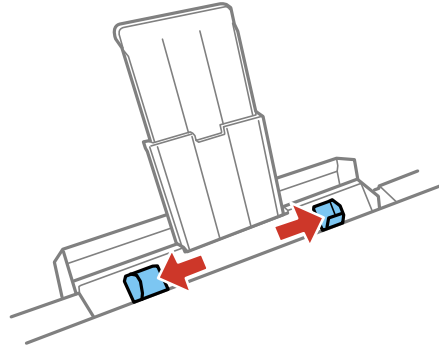

5. Do one of the following:

- Load a single sheet of paper or thick media, printable side up and short edge first, in the center of the rear paper feed slot until you hear a beep. Slide the edge guides against the paper, but not too tightly.

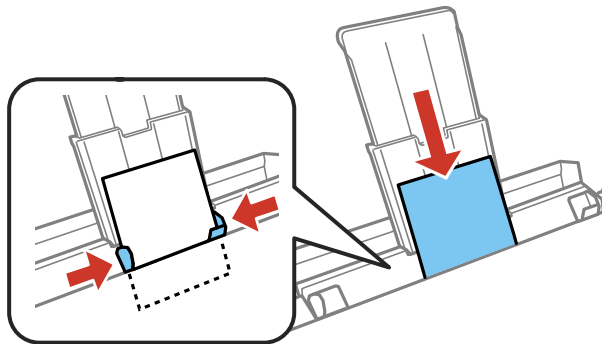

**Note:** If the **Button Press** setting is turned off, you will not hear a beep when inserting paper.

- Load an envelope, short edge first with the flap facing down and to the left, in the center of the rear paper feed slot until you hear a beep. Slide the edge guides against the envelope, but not too tightly.

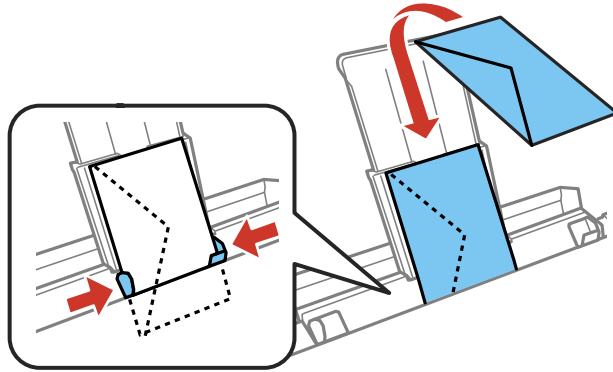

6. When you are ready to print, press the **Start** button.

**Note:** The output tray opens automatically when you print. Leave enough space in front of the product for the paper to be fully ejected. To cancel printing, select **Cancel**.

7. If prompted by the product's LCD screen, select the size and type of the paper you loaded, and select **Done**.

Always follow these loading guidelines:

- Load one sheet or envelope at a time.

- Be careful not to insert paper too far or not far enough. Feed about 2 inches (5 cm) of paper into the printer as shown.

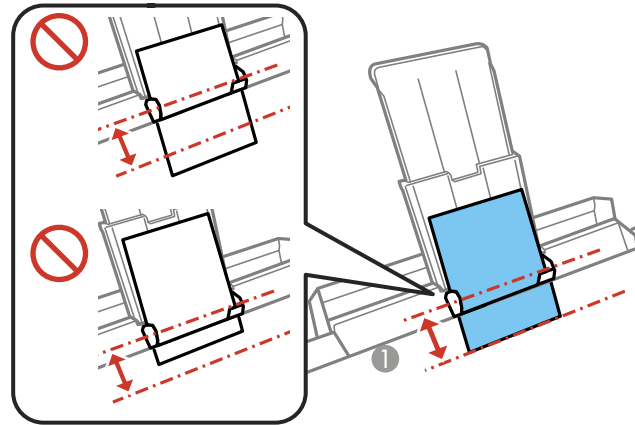

1 2 inches (5 cm)

- Do not insert paper at an angle or the paper may jam or wrinkle.

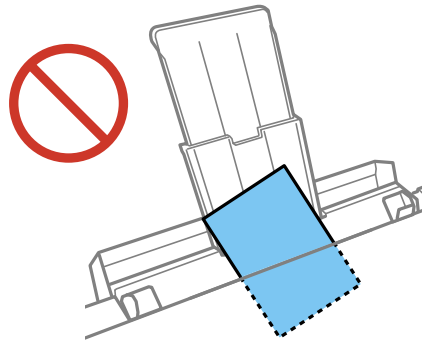

- You can load hole-punched paper with holes on either side, but you may need to adjust the margins in your print file to avoid printing over the holes.

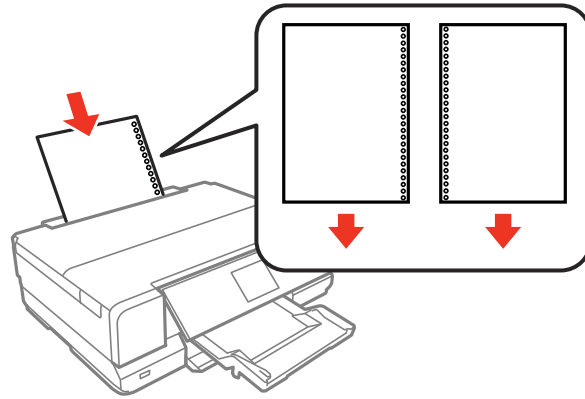

- Check the paper package for any additional loading instructions.

**Parent topic:** [Loading Paper](#)

**Related references**

[Paper Loading Capacity](#)

[Paper or Media Type Settings - Printer Software](#)

[Paper or Media Type Settings - Control Panel](#)

**Related tasks**

[Selecting the Paper Settings for Each Source - Control Panel](#)

[Loading Paper in Cassette 1 \(Upper Cassette\)](#)

[Loading Paper in Cassette 2 \(Lower Cassette\)](#)

[Loading Envelopes](#)

## Loading Envelopes

You can load envelopes in Cassette 2 (lower cassette) as described here. You can print on plain paper envelopes in this size: No. 10 (4.1 × 9.5 inches [105 × 241 mm]).

You can also load a single envelope in the rear paper feed slot, as described in that section.

**Note:** Do not remove or insert the paper cassette during printing.

1. Close the output tray by pressing the ▲ **Output Tray** button or by hand, if necessary.

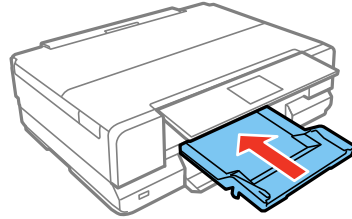

**Note:** As you slide in the output tray, there may be slight resistance and noise. This is normal.

2. Open the front cover.

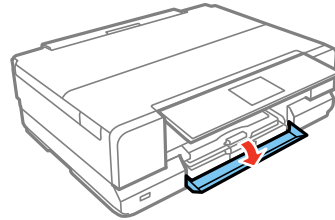

3. Pull on the front cover to remove the lower paper cassette.

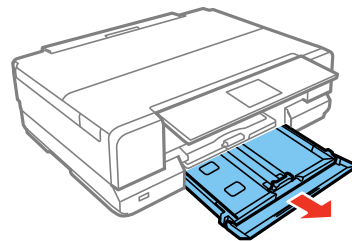

- Slide the edge guides outward.

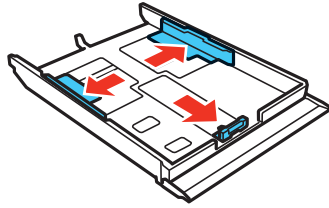

- Insert up to 10 envelopes, printable side down and flap edge left, as shown.

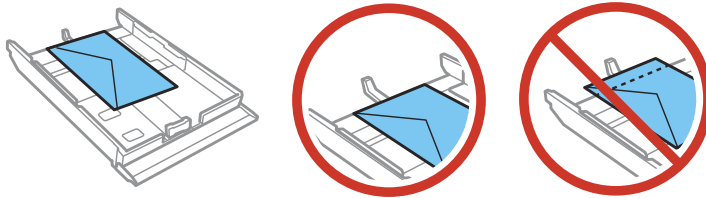

**Note:** Make sure the envelopes are not sticking out from the end of the cassette.

- Slide the edge guides against the envelopes, but not too tightly.

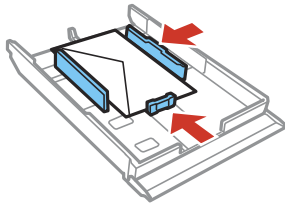

**Note:** Make sure the envelopes are under the tabs on the edge guides.

7. Keep the cassette flat as you insert it.

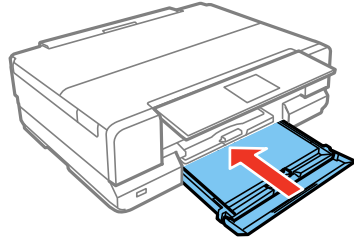

**Note:** The output tray opens automatically when you print. Leave enough space in front of the product for the paper to be fully ejected. Do not remove or insert the paper cassette while the product is operating.

8. If prompted by the product's LCD screen, select the size and type of the envelope you loaded, and select **Done**.

Always follow these envelope loading guidelines:

- If you have trouble loading a stack of envelopes, press each envelope flat before loading it or load one envelope at a time.
- Do not load envelopes that are curled, folded, or too thin.

**Parent topic:** [Loading Paper](#)

#### **Related references**

[Paper Loading Capacity](#)

[Paper or Media Type Settings - Printer Software](#)

[Paper or Media Type Settings - Control Panel](#)

#### **Related tasks**

[Selecting the Paper Settings for Each Source - Control Panel](#)

[Loading Paper in Cassette 2 \(Lower Cassette\)](#)

[Loading Paper in Cassette 1 \(Upper Cassette\)](#)

[Loading Paper in the Rear Paper Feed Slot](#)

## **Selecting the Paper Settings for Each Source - Control Panel**



You can change the default paper size and paper type for each source using the control panel on the product.

1. Press the  home button, if necessary.
2. Select **Setup**.
3. Select **Printer Setup**.
4. Select **Paper Source Setting**.

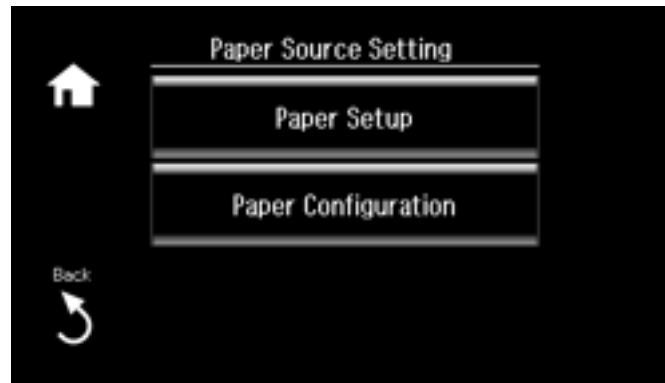
You see this screen:



**Note:** To turn off the automatic display of the paper settings selection screen after paper is loaded in the cassettes, set the **Paper Configuration** setting to **Off**. If you do this, you will not be able to use AirPrint.

5. Select **Paper Setup**.
6. Select the paper source you want to change.
7. Select **Paper Size**.
8. Select the paper size you loaded.
9. Select **Paper Type**.
10. Select the paper type you loaded.
11. Press the  **Back** button to select another paper source to change, or press the  home button to exit.

**Parent topic:** [Loading Paper](#)

## Printing on Thick Paper

If ink smears when you print on thick paper, you can select the Thick Paper setting to improve print quality. Printing is slower with this setting.

1. Press the **⬆️** home button, if necessary.
2. Select **Setup**.
3. Select **Printer Setup**.

You see this screen:



4. Select **Thick Paper**.
5. Select **On**.
6. Press the **⬆️** home button to exit.

Parent topic: [Loading Paper](#)

## Turning Off the Paper Setting Alert

The Paper Setting Alert warns you when the paper settings do not match the paper you loaded. You can turn off this feature from the control panel.

1. Press the **⬆️** home button, if necessary.
2. Select **Setup**.
3. Scroll down and select **Guide Functions**.

You see this screen:

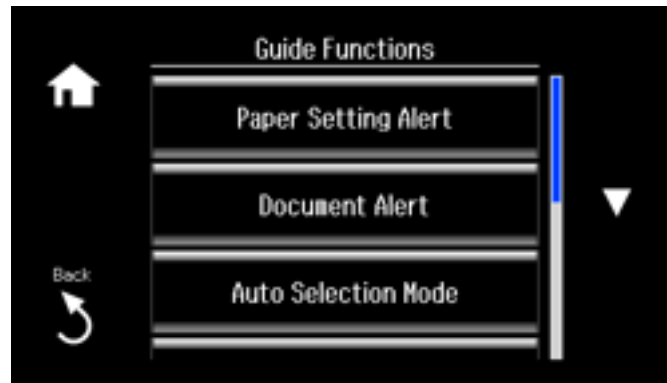

4. Select **Paper Setting Alert**.
5. Select **Off**.
6. Press the  home button to exit.

Parent topic: [Loading Paper](#)

## Paper Loading Capacity

Load one sheet of paper or one envelope at a time in the rear paper feed slot. See the table here for the loading capacity of the paper cassettes.

Paper type	Load up to this many sheets	
	Cassette 2 (lower cassette)	Cassette 1 (upper cassette)
Plain paper	Letter (8.5 × 11 inches [216 × 279 mm]), A4 (8.3 × 11.7 inches [210 × 297 mm]), or Legal (8.5 × 14 inches [216 × 356 mm]) size: 100 sheets	—
Epson Bright White Paper Epson Presentation Paper Matte	80 sheets	—

Paper type	Load up to this many sheets	
	Cassette 2 (lower cassette)	Cassette 1 (upper cassette)
Epson Premium Presentation Paper Matte Epson Ultra Premium Presentation Paper Matte	20 sheets	—
Epson Photo Paper Glossy Epson Premium Photo Paper Glossy Epson Ultra Premium Photo Paper Glossy Epson Premium Photo Paper Semi-gloss Epson Ultra Premium Photo Paper Luster	20 sheets	20 sheets
Epson Premium Presentation Paper Matte Double-sided Epson Photo Quality Self-adhesive Sheets Epson Iron-on Cool Peel Transfer paper Epson Velvet Fine Art Paper Epson Brochure & Flyer Paper Matte Double-sided	1 sheet	—
Envelopes	10 envelopes	—

Parent topic: [Loading Paper](#)

## Available Epson Papers

You can purchase genuine Epson ink and paper at [epson.com/ink3](http://epson.com/ink3) (U.S. sales) or [epson.ca](http://epson.ca) (Canadian sales). You can also purchase supplies from an Epson authorized reseller. To find the nearest one, call 800-GO-EPSON (800-463-7766).

<b>Paper Type</b>	<b>Size</b>	<b>Part number</b>	<b>Sheet count</b>
Epson Bright White Paper	Letter (8.5 × 11 inches [216 × 279 mm])	S041586	500
Epson Photo Paper Glossy	4 × 6 inches (102 × 152 mm)	S041809	50
		S042038	100
	Letter (8.5 × 11 inches [216 × 279 mm])	S041141	20
		S041649	50
		S041271	100
	11 × 17 inches (279 × 432 mm)	S041156	20
Epson Premium Photo Paper Glossy	4 × 6 inches (102 × 152 mm)	S041808	40
		S041727	100
	5 × 7 inches (127 × 178 mm)	S041464	20
	8 × 10 inches (203 × 254 mm)	S041465	20
	Letter (8.5 × 11 inches [216 × 279 mm])	S042183	25
		S041667	50
	11 × 14 inches (279 × 356 mm)	S041466	20
11 × 17 inches (279 × 432 mm)	S041290	20	
A3 (11.7 × 16.5 inches [297 × 420 mm])	S041288	20	
Epson Ultra Premium Photo Paper Glossy	4 × 6 inches (102 × 152 mm)	S042181	60
		S042174	100
	5 × 7 inches (127 × 178 mm)	S041945	20
	8 × 10 inches (203 × 254 mm)	S041946	20
	Letter (8.5 × 11 inches [216 × 279 mm])	S042182	25
		S042175	50

<b>Paper Type</b>	<b>Size</b>	<b>Part number</b>	<b>Sheet count</b>
Epson Ultra Premium Photo Paper Luster	Letter (8.5 × 11 inches [216 × 279 mm])	S041405	50
	A3 (11.7 × 16.5 inches [297 × 420 mm])	S041406	50
Epson Premium Photo Paper Semi-gloss	4 × 6 inches (102 × 152 mm)	S041982	40
	Letter (8.5 × 11 inches [216 × 279 mm])	S041331	20
Epson Presentation Paper Matte	Letter (8.5 × 11 inches [216 × 279 mm])	S041062	100
	Legal (8.5 × 14 inches [216 × 356 mm])	S041067	100
	11 × 17 inches (279 × 432 mm)	S041070	100
Epson Premium Presentation Paper Matte	8 × 10 inches (203 × 254 mm)	S041467	50
	Letter (8.5 × 11 inches [216 × 279 mm])	S041257	50
		S042180	100
	11 × 14 inches (279 × 356 mm)	S041468	50
Epson Premium Presentation Paper Matte Double-sided	Letter (8.5 × 11 inches [216 × 279 mm])	S041568	50
	Letter (8.5 × 11 inches [216 × 279 mm])	S041341	50
Epson Ultra Premium Presentation Paper Matte	A3 (11.7 × 16.5 inches [297 × 420 mm])	S041343	50
	Letter (8.5 × 11 inches [216 × 279 mm])	S042384	150
Epson Brochure & Flyer Paper Matte Double-sided	Letter (8.5 × 11 inches [216 × 279 mm])	S041106	10
Epson Photo Quality Self-adhesive Sheets	A4 (8.3 × 11.7 inches [210 × 297 mm])		

Paper Type	Size	Part number	Sheet count
Epson Iron-on Cool Peel Transfer paper	Letter (8.5 × 11 inches [216 × 279 mm])	S041153	10
Epson Velvet Fine Art Paper	Letter (8.5 × 11 inches [216 × 279 mm])	S041636	20

Parent topic: [Loading Paper](#)

## Borderless Paper Type Compatibility

You can print borderless photos on compatible paper types in compatible sizes:

### Borderless Paper Types

- Epson Photo Paper Glossy
- Epson Premium Photo Paper Glossy
- Epson Ultra Premium Photo Paper Glossy
- Epson Premium Photo Paper Semi-gloss
- Epson Ultra Premium Photo Paper Luster
- Epson Premium Presentation Paper Matte
- Epson Ultra Premium Presentation Paper Matte

### Borderless Paper Sizes

- 4 × 6 inches (102 × 152 mm)
- 16:9 wide (4 × 7.1 inches [102 × 181 mm])
- 5 × 7 inches (127 × 178 mm)
- 8 × 10 inches (203 × 254 mm)
- Letter (8.5 × 11 inches [216 × 279 mm])
- A4 (8.3 × 11.7 inches [210 × 297 mm])
- A3 (11.7 × 16.5 inches [297 × 420 mm])
- 11 × 17 inches (279 × 432 mm)

Parent topic: [Loading Paper](#)

## Paper or Media Type Settings - Control Panel

For this paper	Select this Paper Type setting
Plain paper Epson Bright White Paper Epson Iron-on Cool Peel Transfer paper Epson Photo Quality Self-adhesive Sheets	<b>Plain Paper</b>
Epson Ultra Premium Photo Paper Glossy	<b>Ultra Glossy</b>
Epson Premium Photo Paper Glossy	<b>Prem. Glossy</b>
Epson Photo Paper Glossy	<b>Glossy</b>
Epson Presentation Paper Matte	<b>Presentation Matte</b>
Epson Premium Photo Paper Semi-gloss	<b>Prem. Semi-Gloss</b>
Epson Ultra Premium Photo Paper Luster	<b>Ultra Luster</b>
Epson Premium Presentation Paper Matte Epson Premium Presentation Paper Matte Double-sided Epson Ultra Premium Presentation Paper Matte Epson Brochure & Flyer Paper Matte Double-sided	<b>Prem. Matte</b>
Epson Velvet Fine Art Paper	<b>Velvet Fine Art Paper</b>
Envelopes	<b>Envelope</b>

Parent topic: [Loading Paper](#)

## Paper or Media Type Settings - Printer Software

For this paper	Select this paper Type or Media Type setting
Plain paper Epson Bright White Paper Epson Iron-on Cool Peel Transfer paper Epson Photo Quality Self-adhesive Sheets	Plain Paper/Bright White Paper

<b>For this paper</b>	<b>Select this paper Type or Media Type setting</b>
Epson Ultra Premium Photo Paper Glossy	Ultra Premium Photo Paper Glossy
Epson Premium Photo Paper Glossy	Premium Photo Paper Glossy
Epson Photo Paper Glossy	Photo Paper Glossy
Epson Presentation Paper Matte	Presentation Paper Matte
Epson Premium Photo Paper Semi-gloss	Premium Photo Paper Semi-Gloss
Epson Ultra Premium Photo Paper Luster	Ultra Premium Photo Paper Luster
Epson Premium Presentation Paper Matte Epson Premium Presentation Paper Matte Double-sided Epson Ultra Premium Presentation Paper Matte Epson Brochure & Flyer Paper Matte Double-sided	Premium Presentation Paper Matte
Epson Velvet Fine Art Paper	Velvet Fine Art Paper
Envelopes	Envelope

**Note:** The settings listed here are available only when printing from your computer; they do not apply to your product's control panel settings.

**Parent topic:** [Loading Paper](#)

---

## Placing Originals on the Product

Follow the instructions here to place your original documents or photos on the product.

**Caution:** Do not place anything on top of your product or use its cover as a writing surface to avoid damaging it.

### Placing Originals on the Scanner Glass

## Placing Originals on the Scanner Glass

You can place originals up to this size on the scanner glass: Letter (8.5 × 11 inches [216 × 279 mm]) or A4 (8.3 × 11.7 inches [210 × 297 mm]).

1. Open the document cover.

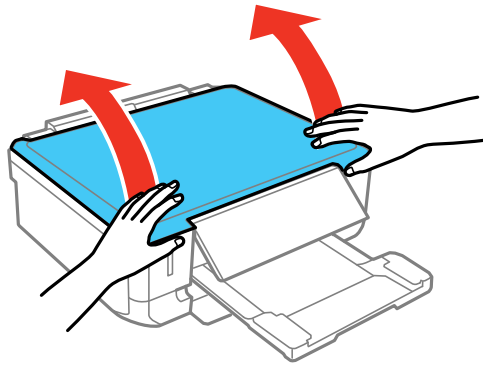

2. Place your original facedown on the scanner glass with the top of the original facing into the corner shown. Slide the original to the edges of the indicated corner.

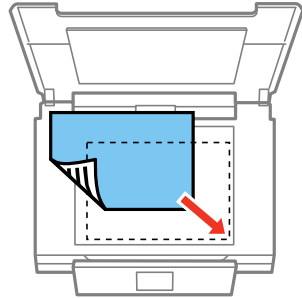

**Note:** You can place multiple originals on the scanner glass. Just make sure they are at least 0.20 inch (5 mm) away from each other and from the edge of the scanner glass.

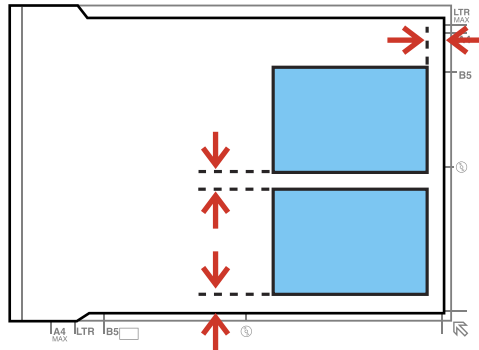

3. If you are copying two book pages onto one sheet, place the book as shown to copy the first page, then turn the book as shown to copy the second page.

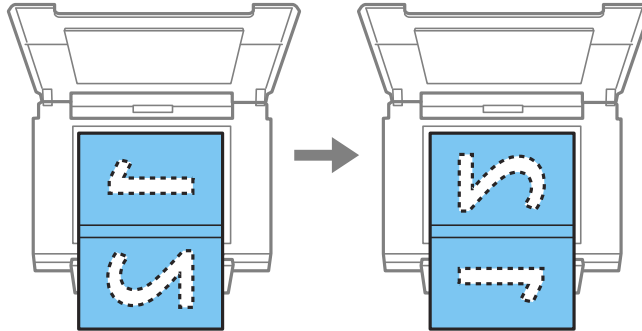

4. Close the document cover gently to keep your original in place.

**Parent topic:** [Placing Originals on the Product](#)

**Related topics**

[Copying](#)

[Scanning](#)

---

# Copying

See the information here to copy documents or photos using your product.

**Note:** Copies may not be exactly the same size as your originals.

[Copying Documents or Photos](#)

[Copying and Restoring Photos](#)

## Related tasks

[Copying onto a CD/DVD](#)

## Copying Documents or Photos

You can copy documents or photos onto various sizes and types of paper, including Epson special papers.

1. Place your original document or photo on the scanner glass.
2. Load the paper you want to print on.

**Note:** Load only the recommended number of sheets.

3. Press the  home button, if necessary.
4. Select **Copy**.



5. To print more than one copy, press the **+** or **-** button to select the number (up to 99).
6. Select **Color** or **B&W**.
7. Scroll down to view and change additional copy settings, if necessary.
8. When you are ready to copy, press the **Start** button.

**Note:** To cancel copying, select **Cancel**.

[Paper Type Settings - Copying](#)

[Paper Size Settings - Copying](#)

[Copying Options](#)

**Parent topic:** [Copying](#)

**Related references**

[Paper Loading Capacity](#)

[Available Epson Papers](#)

**Related tasks**

[Placing Originals on the Scanner Glass](#)

## Paper Type Settings - Copying

Select a **Paper Type** setting that matches the paper you loaded.

Paper type loaded	Paper Type setting
Plain paper Epson Bright White Paper Epson High Quality Ink Jet Paper Epson Iron-on Cool Peel Transfer paper Epson Photo Quality Self-adhesive Sheets	Plain Paper
Epson Presentation Paper Matte	Presentation Matte
Epson Premium Presentation Paper Matte Epson Ultra Premium Presentation Paper Matte Epson Premium Presentation Paper Matte Double-sided	Prem. Matte

Paper type loaded	Paper Type setting
Epson Premium Photo Paper Glossy Epson Ultra Premium Photo Paper Luster	Prem. Glossy
Epson Ultra Premium Photo Paper Glossy	Ultra Glossy
Epson Photo Paper Glossy	Glossy
Epson Premium Photo Paper Semi-gloss	Prem. Semi-Gloss
Epson Velvet Fine Art Paper	Velvet Fine Art paper

Parent topic: [Copying Documents or Photos](#)

## Paper Size Settings - Copying

Select the **Paper Size** setting that matches the paper you loaded.

**Note:** You can copy photos only on these paper sizes.

- 4 × 6 inches (102 × 152 mm)
- 5 × 7 inches (127 × 178 mm)
- 8 × 10 inches (203 × 254 mm)
- Letter (8.5 × 11 inches [216 × 279 mm])
- A4 (8.3 × 11.7 inches [210 × 297 mm])
- A3 (11.7 × 16.5 inches [297 × 420 mm])
- 11 × 17 inches (279 × 432 mm)

Parent topic: [Copying Documents or Photos](#)

## Copying Options

Select the copying options you want to use for your copies.

**Note:** Not all options or settings may be available, depending on other copying settings.

Copying option	Available settings	Description
Density	Varying levels	Adjusts the lightness or darkness of copies

Copying option	Available settings	Description
<b>Remove Background</b>	<b>Off</b>	Removes or lightens the background color. May not remove very dark or vivid colors.
	<b>On</b>	
<b>2-Sided Copying</b>	<b>1&gt;1-Sided</b>	Selects 1-sided or make 2-sided copies
	<b>1&gt;2-Sided</b>	
<b>Layout</b>	<b>With Border</b>	Leaves a small margin around the image
	<b>Borderless</b>	Expands the image to the edge of the paper (slight cropping may occur)
	<b>A4, 2-up Copy</b>	Copies 2 originals onto a single A4-size sheet
	<b>Letter, 2-up Copy</b>	Copies 2 originals onto a single letter-size sheet
	<b>A4, Book/2-up</b>	Copies 2 pages of a book or magazine onto a single A4-size sheet
	<b>Letter, Book/2-up</b>	Copies 2 pages of a book or magazine onto a single letter-size sheet
	<b>Book/2-sided</b>	Copies 2 pages of a book or magazine onto both sides of a single sheet (only available when <b>1&gt;2-Sided</b> is selected)
<b>Reduce/Enlarge</b>	<b>Custom Size</b>	Automatically sizes the image by the percentage you select
	<b>Actual Size</b>	Copies at 100% size
	<b>Auto Fit Page</b>	Automatically sizes the image to fit the selected paper size setting
	<b>Letter-&gt;4x6in</b> and other conversions	Automatically converts from one size to another
<b>Paper Size</b>	Various sizes	Selects the paper size for the copy printout
<b>Paper Type</b>	Various types	Adjusts printer settings for the selected paper type

Copying option	Available settings	Description
<b>Paper Source</b>	<b>Cassette 1</b>	Copies onto paper loaded in Cassette 1 (upper cassette)
	<b>Cassette 2</b>	Copies onto paper loaded in Cassette 2 (lower cassette)
	<b>Rear Paper Feed Slot</b>	Copies onto paper loaded in the rear paper feed slot
<b>Document Type</b>	<b>Text</b>	Copies a text document
	<b>Text &amp; Image</b>	Copies a document that includes text and images
	<b>Photo</b>	Copies a photograph
<b>Quality</b>	<b>Draft</b>	Provides lower quality for draft copies (plain paper only)
	<b>Standard</b>	Provides good quality for most copies
	<b>Best</b>	Provides the highest quality for special copies
<b>Document Orientation</b>	<b>Portrait</b>	Specifies the orientation of your originals (only available when <b>1&gt;2-Sided</b> is selected)
	<b>Landscape</b>	
<b>Binding Margin</b>	<b>Left Edge</b>	Specifies the binding edge of your double-sided copies (only available when <b>1&gt;2-Sided</b> is selected)
	<b>Top Edge</b>	
<b>Expansion</b>	<b>Standard</b>	Adjusts the amount of expansion for printing borderless photos
	<b>Medium</b>	
	<b>Minimum</b>	
<b>Dry Time</b>	<b>Standard</b>	Provides longer drying time for 2-sided copies, if smudges or marks appear on the front of the paper when you print on the second side
	<b>Long</b>	
	<b>Longer</b>	
<b>Clear All Settings</b>	—	Restores the copy settings to the default settings

Parent topic: [Copying Documents or Photos](#)

## Copying and Restoring Photos

You can restore the colors in faded photos as you copy them.

1. Load photo paper in the product.
2. Press the  home button, if necessary.
3. Select **More Functions**.
4. Select **Copy/Restore Photos**.



5. Select **On**.
6. Place up to two original photos on the product.  
**Note:** View the LCD screen for instructions on placing your photos on the product.
7. Press the  **Start** button.
8. Press the **+** or **-** button to select one or more copies of the photo (up to 99).
9. If you placed two originals on the scanner, press the left or right arrow button to view the second original. Then press the **+** or **-** button to select one or more copies of the photo (up to 99).
10. To adjust your print and copy settings, do one or more of the following:
  - To change the print settings, select **Settings** and select the necessary settings.
  - To adjust the copy image, select **Edit > Photo Adjustments** and select your settings.
  - To add a B&W filter to the copy, select **Edit > Filter** and select the **B&W** setting.

- To crop or zoom into your photo, select **Edit > Crop/Zoom** and press the icons displayed on the LCD screen to crop your image.

11. When you are ready to print, press the **Start** button.

**Note:** To cancel copying, select **Cancel**.

**Parent topic:** [Copying](#)

**Related references**

[Paper Loading Capacity](#)

[Available Epson Papers](#)

[Paper Type Settings - Copying](#)

[Paper Size Settings - Copying](#)

[Copying Options](#)

**Related tasks**

[Placing Originals on the Scanner Glass](#)

---

# Printing from a Computer

Before printing from your computer, make sure you have set up your product and installed its software as described on the *Start Here* sheet.

**Note:** If you have an Internet connection, it is a good idea to check for updates to your product software on Epson's support website. If you see a Software Update screen, select **Enable automatic checking** and click **OK**. The update scans your system to see if you have the latest product software. Follow the on-screen instructions.

[Printing with Windows](#)

[Printing with OS X](#)

[Cancelling Printing Using a Product Button](#)

## Printing with Windows

You can print with your product using any Windows application, as described in these sections.

[Selecting Basic Print Settings - Windows](#)

[Selecting Double-sided Printing Settings - Windows](#)

[Selecting Additional Layout and Print Options - Windows](#)

[Selecting a Printing Preset - Windows](#)

[Selecting Extended Settings - Windows](#)

[Printing Your Document or Photo - Windows](#)

[Selecting Default Print Settings - Windows](#)

[Changing Automatic Update Options](#)

**Parent topic:** [Printing from a Computer](#)

## Selecting Basic Print Settings - Windows

Select the basic settings for the document or photo you want to print.

1. Open a photo or document for printing.
2. Select the print command in your application.

**Note:** You may need to select a print icon on your screen, the **Print** option in the **File** menu, or another command. See your application's help utility for details.

3. If necessary, select your product name as the printer you want to use.

**Note:** You may also need to select **Properties** or **Preferences** to view your print settings.

You see the Main tab of your printer settings window:

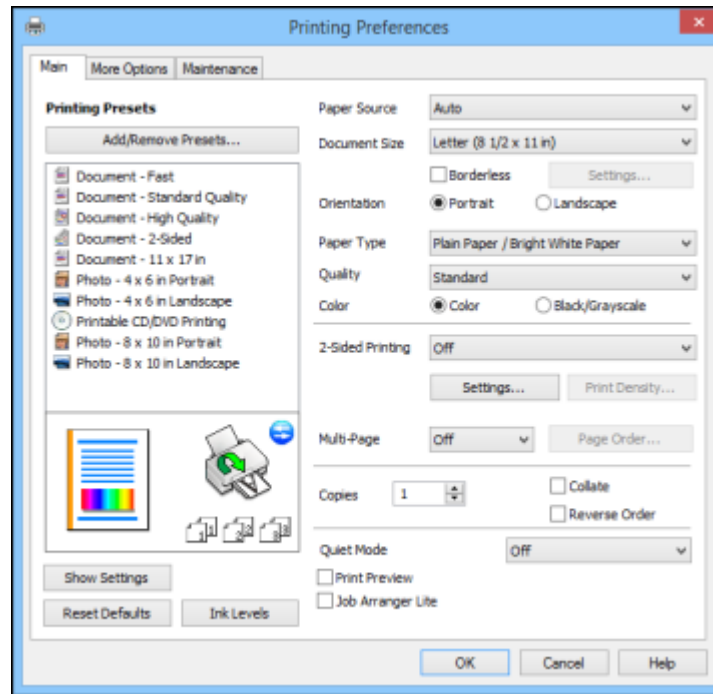

4. For the **Paper Source** setting, select where you loaded the paper you want to print on.
5. Select the size of the paper you loaded as the **Document Size** setting.

**Note:** You can also select the **User-Defined** setting to create a custom paper size, but you will not be able to use the **Borderless** setting.

6. If you are printing a borderless photo, select **Borderless**. You can click **Settings** to access additional options for borderless printing.

**Note:** You must select a compatible borderless paper type and size to print without borders. Check the borderless paper compatibility list for details.

7. Select the orientation of your document.

**Note:** If you are printing an envelope, select **Landscape**.

8. Select the type of paper you loaded as the **Paper Type** setting.

**Note:** The setting may not exactly match the name of your paper. Check the paper type settings list for details.

9. Select the **Quality** setting that matches the print quality you want to use.

10. Select a Color option:

- To print a color document or photo, select the **Color** setting.
- To print text and graphics in black or shades of gray, select the **Black/Grayscale** setting.

11. To print on both sides of the paper, select a **2-Sided Printing** option.

12. To print multiple pages on one sheet of paper, or print one image on multiple sheets of paper, select one of the settings in the **Multi-Page** menu and select the printing options you want.

13. To print multiple copies and arrange their print order, select the **Copies** options.

14. To reduce noise during printing when you select **Plain Paper/Bright White Paper**, select **Quiet Mode** (printing will be slower).

15. To preview your job before printing, select **Print Preview**.

16. To save your print job as a project that can be modified and combined with other print jobs, select **Job Arranger Lite**.

[Paper Source Options - Windows](#)

[Print Quality Options - Windows](#)

[Multi-Page Printing Options - Windows](#)

**Parent topic:** [Printing with Windows](#)

#### **Related references**

[Paper or Media Type Settings - Printer Software](#)

[Borderless Paper Type Compatibility](#)

**Related tasks**

[Selecting Double-sided Printing Settings - Windows](#)

[Turning On Quiet Mode](#)

**Paper Source Options - Windows**

You can select any of the available options in the Paper Source menu to print on the paper loaded in that source.

**Auto Cassette Selection**

Automatically selects the paper source based on the selected paper size.

**Cassette 1**

Selects the paper in cassette 1 as the paper source.

**Cassette 2**

Selects the paper in cassette 2 as the paper source.

**Cassette 1 > Cassette 2**

Selects the paper in cassette 1 as the paper source and automatically switches to cassette 2 when cassette 1 is empty.

**Rear Paper Feed Slot**

Selects the paper in the rear feed slot as the paper source.

**CD/DVD Tray**

Selects the CD or DVD loaded in the CD/DVD tray.

**Parent topic:** [Selecting Basic Print Settings - Windows](#)

**Print Quality Options - Windows**

You can select any of the available Quality options to fine-tune the quality of your print. Some settings may be unavailable, depending on the paper type and border setting you have chosen.

**Draft**

For draft printing on plain paper.

**Standard**

For everyday text and image printing.

**High**

For photos and graphics with high print quality.

**More Settings**

Opens a window that lets you choose among levels of speed and quality.

Parent topic: [Selecting Basic Print Settings - Windows](#)

## Multi-Page Printing Options - Windows

You can select any of the available options in the Multi-Page menu to set up your multi-page print job.

### 2-Up and 4-Up

Prints 2 or 4 pages on one sheet of paper. Click the **Page Order** button to select page layout and border options.

### 2×1 Poster, 2×2 Poster, 3×3 Poster, 4×4 Poster

Prints one image on multiple sheets of paper to create a larger poster. Click the **Settings** button to select image layout and guideline options.

Parent topic: [Selecting Basic Print Settings - Windows](#)

## Selecting Double-sided Printing Settings - Windows

You can print on both sides of the paper by selecting one of the **2-Sided Printing** options on the Main tab.

**Note:** Some options may be pre-selected or unavailable, depending on other settings you have chosen or if you are accessing the product over a network.

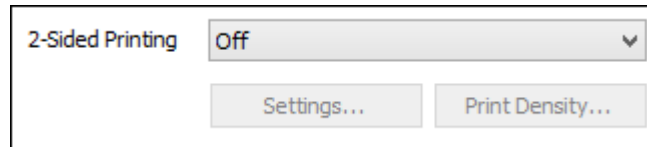

1. Select one of the following options for **2-Sided Printing**:
  - **Auto (Long-edge binding)** to print your double-sided print job by automatically flipping the paper on the long edge.
  - **Auto (Short-edge binding)** to print your double-sided print job by automatically flipping the paper on the short edge.
  - **Manual (Long-edge binding)** to print your double-sided print job by printing one side and prompting you to flip the paper over on the long edge to print the other side (recommended for paper types that do not support automatic duplexing).
  - **Manual (Short-edge binding)** to print your double-sided print job by printing one side and prompting you to flip the paper over on the short edge to print the other side (recommended for paper types that do not support automatic duplexing).

2. Click the **Settings** button.

You see this window:

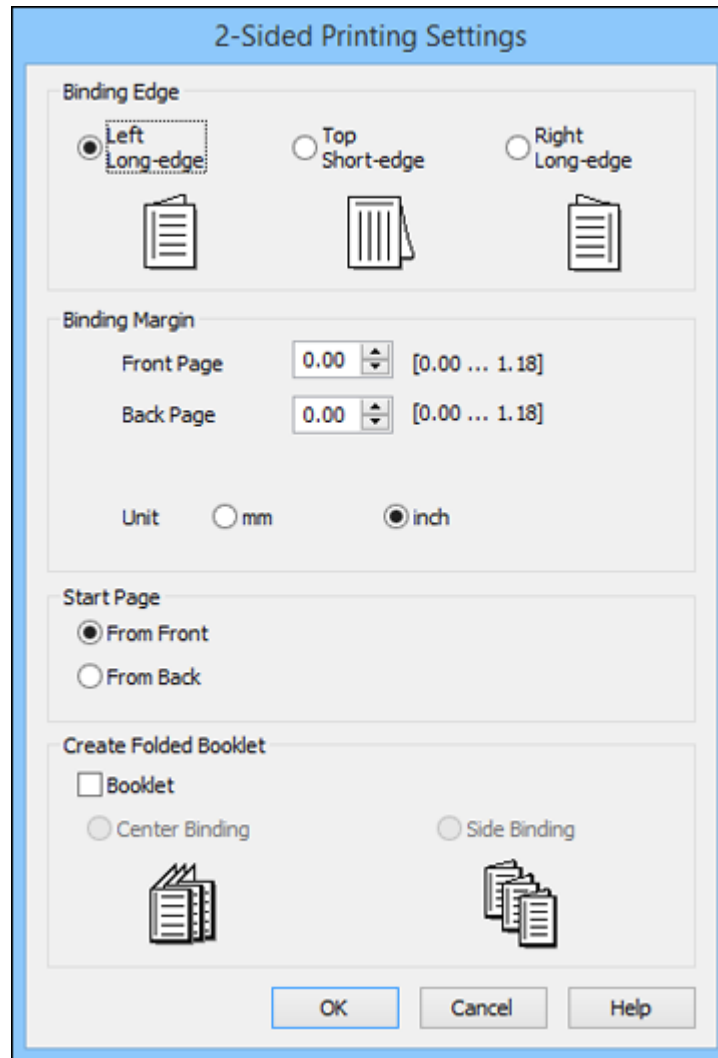

3. Select the double-sided printing options you want to use.
4. Click **OK** to return to the Main tab.

5. Click the **Print Density** button.

You see this window:

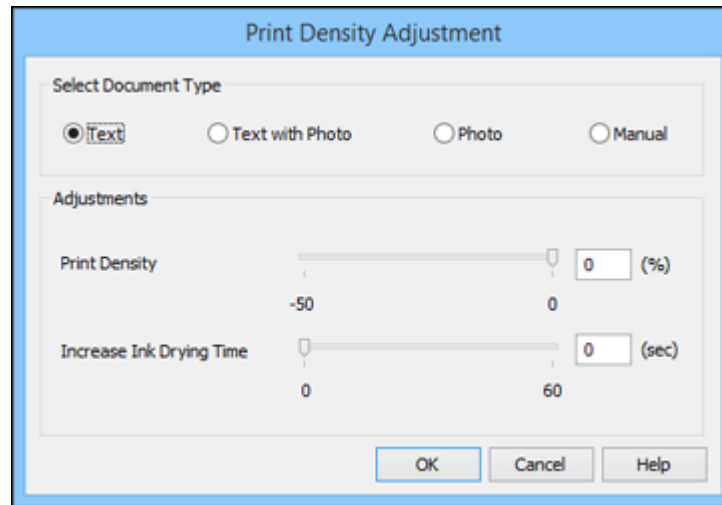

6. Select the type of document you are printing as the Document Type setting. The software automatically sets the **Adjustments** options for that document type.
7. If necessary, select the **Adjustments** options you want to use.
8. Click **OK** to return to the Main tab.
9. Print a test copy of your double-sided document to test the selected settings.
10. Follow any instructions displayed on the screen during printing.

[Double-sided Printing Options - Windows](#)

[Print Density Adjustments - Windows](#)

**Parent topic:** [Printing with Windows](#)

### **Double-sided Printing Options - Windows**

You can select any of the available options on the 2-Sided Printing Settings window to set up your double-sided print job.

#### **Binding Edge Options**

Select a setting that orients double-sided print binding in the desired direction.

**Binding Margin Options**

Select options that define a wider margin to allow for binding.

**Start Page**

Selects whether printing starts on the front or back page.

**Create Folded Booklet Options**

Select the **Booklet** checkbox and a binding option to print double-sided pages as a booklet.

**Parent topic:** [Selecting Double-sided Printing Settings - Windows](#)

**Print Density Adjustments - Windows**

You can select any of the available options on the Print Density Adjustment window to adjust the print quality of your double-sided print job.

**Print Density**

Sets the level of ink coverage for double-sided printing.

**Increase Ink Drying Time**

Sets the amount of time required for drying ink after printing on one side of the paper before printing the other side in double-sided printing to prevent ink smearing.

**Parent topic:** [Selecting Double-sided Printing Settings - Windows](#)

## Selecting Additional Layout and Print Options - Windows

You can select a variety of additional layout and printing options for your document or photo on the More Options tab.

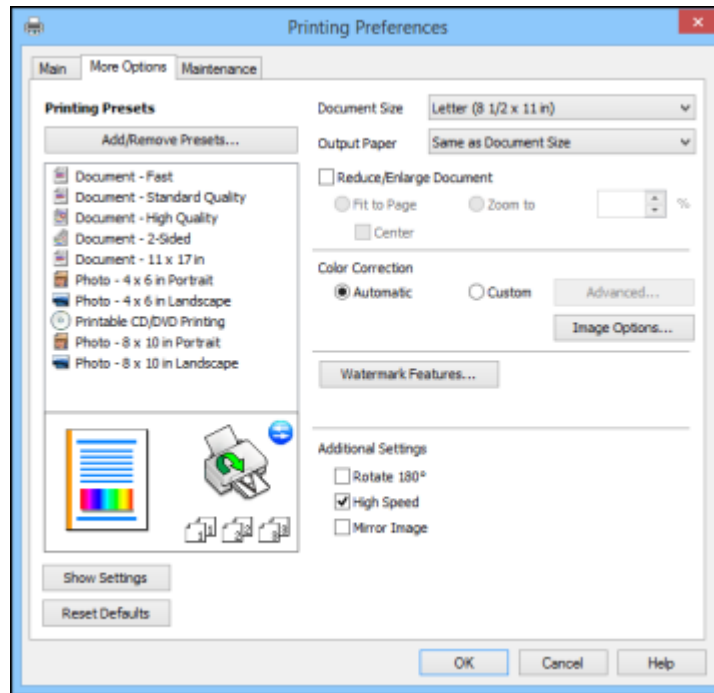

1. To change the size of your printed document or photo, select the **Reduce/Enlarge Document** checkbox and select one of these sizing options:
  - Select the **Fit to Page** option to size your image to fit the paper you loaded. Select the size of the your document or photo as the **Document Size** setting, and the size of your paper as the **Output Paper** setting. If you want to center your image on the paper, select the **Center** option.
  - Select the **Zoom to** option to reduce or enlarge your document or photo by a specific percentage. Select the percentage in the % menu.
2. Select one of the following Color Correction options:
  - Select **Automatic** to automatically adjust the sharpness, brightness, contrast, and color saturation for your image.

- Select **Custom** and click the **Advanced** button to manually adjust the color correction settings or turn off color management in your printer software.
- Select **Image Options** to access additional settings for improving printed images.

**Note:** You can also select **Color Universal Print** settings.

3. To add the following features, click the **Watermark Features** button:

- **Watermark:** adds a visible watermark to your printout.

**Note:** Click the **Add/Delete** button to create your own watermark, and click the **Settings** button to customize the watermark.

- **Header/Footer:** adds information such as the date and time to the top or bottom of your printout.

**Note:** Click the **Settings** button to customize the text and location of the header or footer.

4. Select any of the Additional Settings options to customize your print.

[Custom Color Correction Options - Windows](#)

[Image Options and Additional Settings - Windows](#)

[Header/Footer Settings - Windows](#)

**Parent topic:** [Printing with Windows](#)

## Custom Color Correction Options - Windows

You can select any of the available options in the Color Correction window to customize the image colors for your print job.

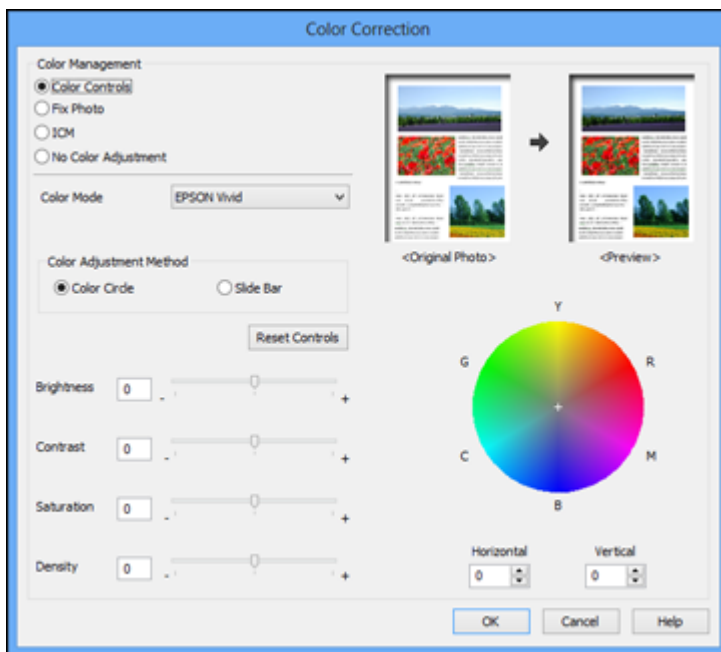

### Color Controls

Lets you select a **Color Mode** setting, individual settings for **Brightness**, **Contrast**, **Saturation**, and **Density**, and individual color tones. Depending on the selected color mode, you can also adjust the midtone density using the **Gamma** setting.

### Fix Photo

Improves the color, contrast, and sharpness of flawed photos.

**Note:** Fix Photo uses a sophisticated face recognition technology to optimize photos that include faces. For this to work, both eyes and the nose must be visible in the subject's face. If your photo includes a face with an intentional color cast, such as a statue, you may want to turn off **Fix Photo** to retain the special color effects.

**ICM**

Lets you manage color using installed color printing profiles.

**No Color Adjustment**

Turns off color management in your printer software so you can manage color using only your application software.

**Parent topic:** [Selecting Additional Layout and Print Options - Windows](#)

**Image Options and Additional Settings - Windows**

You can select any of the Image Options and Additional Settings to customize your print. Some options may be pre-selected or unavailable, depending on other settings you have chosen.

**Image Options****Emphasize Text**

Adjusts the weight of printed text to increase readability.

**Emphasize Thin Lines**

Adjusts the weight of printed lines to increase visibility.

**Edge Smoothing**

Smooths jagged edges in low-resolution images such as screen captures or images from the Web.

**Fix Red-Eye**

Reduces or removes red-eye in photos.

**Print Text in Black**

Prints colored text in black.

**For Color Text**

Prints colored text on a background pattern or underlined.

**For Color Graphs and Images**

Prints colored graphics and images with overlay patterns.

**For Color Text, Graphs, and Images**

Prints colored text, graphics, and images with overlay patterns.

**Enhancement Options**

Specifies Color Universal Print enhancement settings for text, graphics, and images.

**Additional Settings Options****Rotate 180°**

Prints the image rotated 180° from its original orientation.

**High Speed**

Speeds up printing but may reduce print quality.

**Mirror Image**

Flips the printed image left to right.

**Parent topic:** [Selecting Additional Layout and Print Options - Windows](#)

**Header/Footer Settings - Windows**

You can select any of the Header/Footer Settings options to add headers or footers when you print. The items are available to print at the top or bottom of your pages, in either the left, right, or center of the page.

**Note:** These settings are not saved with your document.

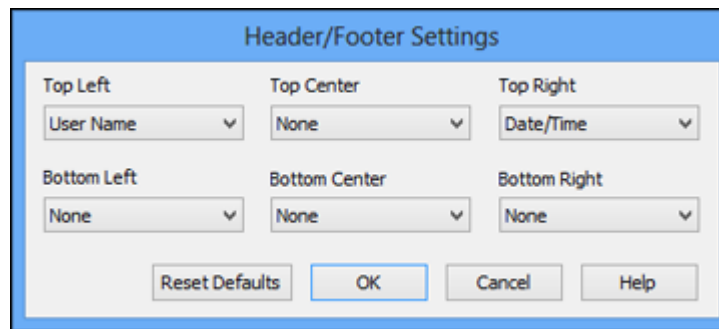

You can select to print the following information:

- User Name
- Computer Name
- Date
- Date/Time
- Collate Number (copy number)

**Note:** The user name, computer name, date, and time come from the Windows Control Panel on your computer.

**Parent topic:** [Selecting Additional Layout and Print Options - Windows](#)

## Selecting a Printing Preset - Windows

For quick access to common groups of print settings, you can select a printing preset on the Main or More Options tab.

**Note:** You can create your own preset by clicking the **Add/Remove Presets** button.

1. Click the **Main** or **More Options** tab.

You see the available **Printing Presets** on the left:

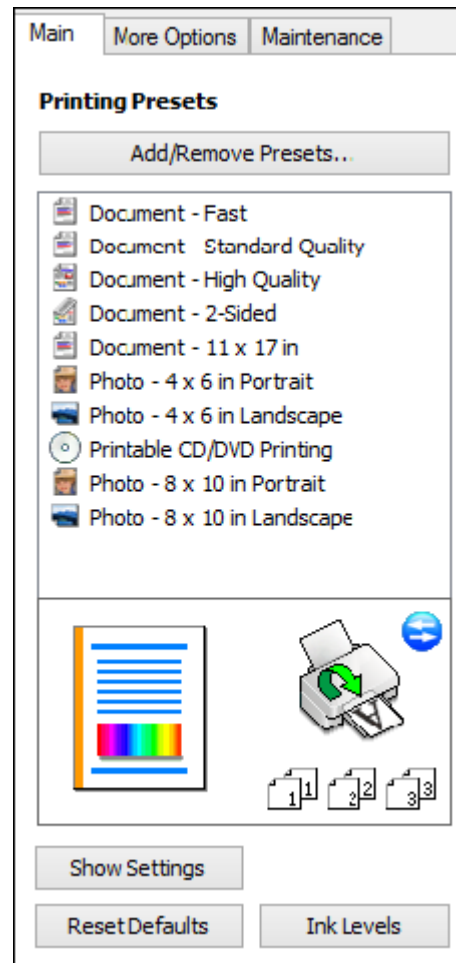

2. Place your cursor over one of the **Printing Presets** to view its list of settings.
3. Click on a preset to change its settings, or use any of the available options on the screen to control your printing presets.
4. To choose a preset for printing, select it.
5. Click **OK**.

**Parent topic:** [Printing with Windows](#)

**Related tasks**

[Selecting Basic Print Settings - Windows](#)

[Selecting Additional Layout and Print Options - Windows](#)

## Selecting Extended Settings - Windows

You can select additional settings that apply to all the print jobs you send to your product.

1. Access the Windows Desktop and right-click the product icon in the Windows taskbar.
2. Select **Printer Settings**.
3. Click the **Maintenance** tab.

You see the maintenance options:

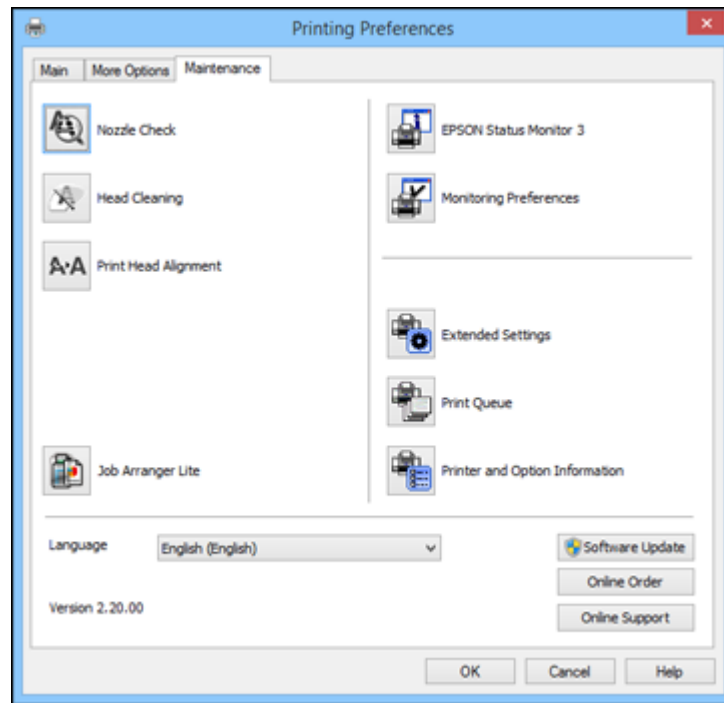

4. Click the **Extended Settings** button.

You see this window:

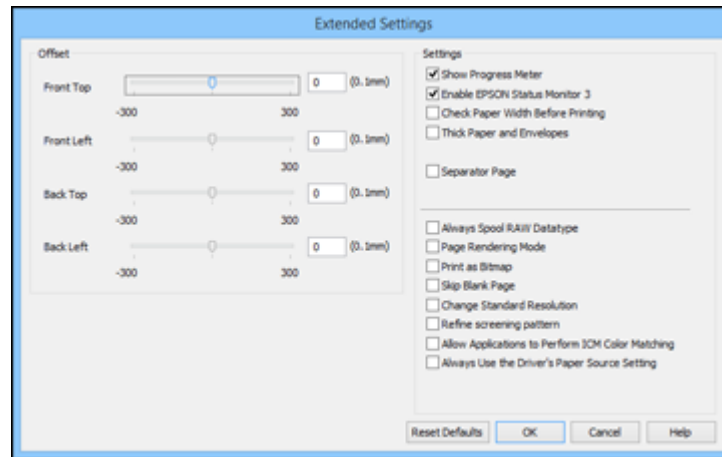

5. Select any of the extended settings to customize your print.
6. Click **OK** to close the Extended Settings window.
7. Click **OK** to close the printer software window.

[Extended Settings - Windows](#)

**Parent topic:** [Printing with Windows](#)

### **Extended Settings - Windows**

You can select from these settings on the Extended Settings window.

#### **Show Progress Meter**

Displays the progress of print jobs as they are being printed.

#### **Enable EPSON Status Monitor 3**

Enables product monitoring for ink and paper supplies and other issues.

#### **Check Paper Width Before Printing**

Prevents printing beyond the edges of the paper if the paper size setting is incorrect; may reduce print speed.

#### **Thick Paper and Envelopes**

Prevents ink from smearing when you print on envelopes or other thick paper.

**Separator Page**

Before each document, prints a separator page containing the title, user, date, and time.

**Always Spool RAW Datatype**

Increases print speed and may solve other printing problems.

**Page Rendering Mode**

Increases print speed when printing is extremely slow or the print head stops during printing.

**Print as Bitmap**

Increases print speed when printing is extremely slow or the print head stops during printing, and other settings do not help.

**Skip Blank Page**

Ensures that your product does not print pages that contain no text or images.

**Change Standard Resolution**

Reduces the resolution of print data to correct printing problems.

**Refine screening pattern**

Prints graphics with a finer screening pattern.

**Allow Applications to Perform ICM Color Matching**

Allows applications to perform ICM color matching.

**Always Use the Driver's Paper Source Setting**

Prints using the paper source setting in the printer driver, rather than the setting in your application.

Parent topic: [Selecting Extended Settings - Windows](#)

## Printing Your Document or Photo - Windows

Once you have selected your print settings, you are ready to save your settings and print.

1. Click **OK** to save your settings.

You see your application's Print window, such as this one:

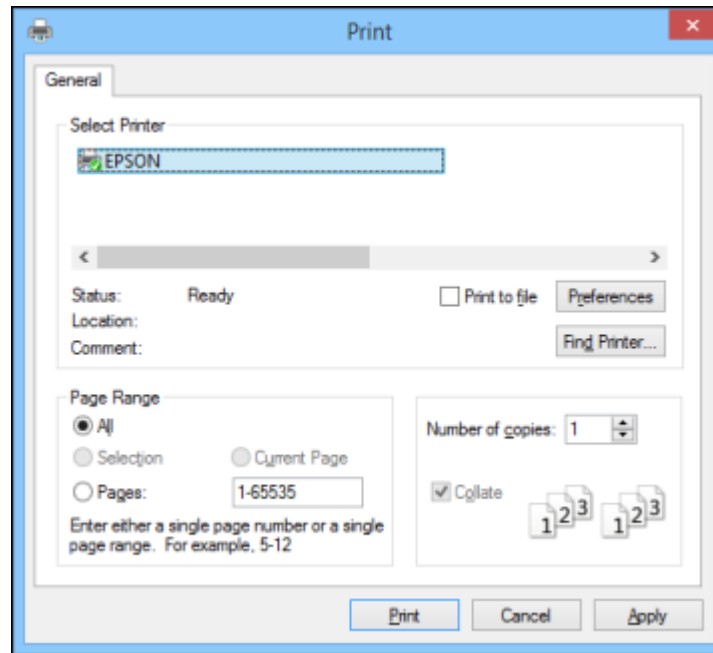

2. Click **OK** or **Print** to start printing.

[Checking Print Status - Windows](#)

**Parent topic:** [Printing with Windows](#)

#### **Related tasks**

[Selecting Basic Print Settings - Windows](#)

[Selecting Additional Layout and Print Options - Windows](#)

## Checking Print Status - Windows

During printing, you see this window showing the progress of your print job. It allows you to control printing and check ink cartridge status.

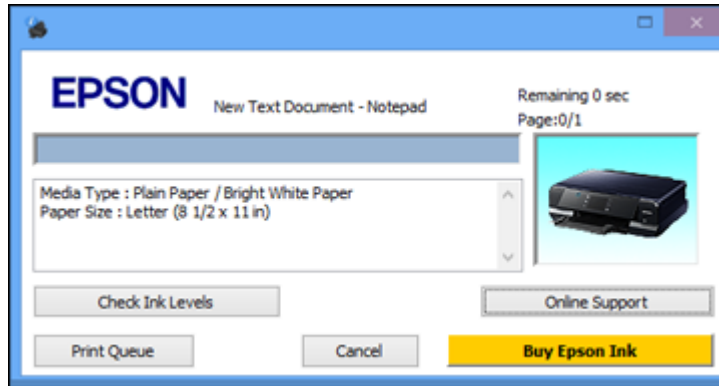

- To cancel printing, click **Cancel**.
- To see print jobs waiting to print, click **Print Queue**.
- To check ink status, click **Consumables Status**.

**Parent topic:** [Printing Your Document or Photo - Windows](#)

## Selecting Default Print Settings - Windows

When you change your print settings in a program, the changes apply only while you are printing in that program session. If you want to change the print settings you use in all your Windows programs, you can select new default print settings.

1. Access the Windows Desktop and right-click the product icon in the Windows taskbar.
2. Select **Printer Settings**.

You see the printer settings window:

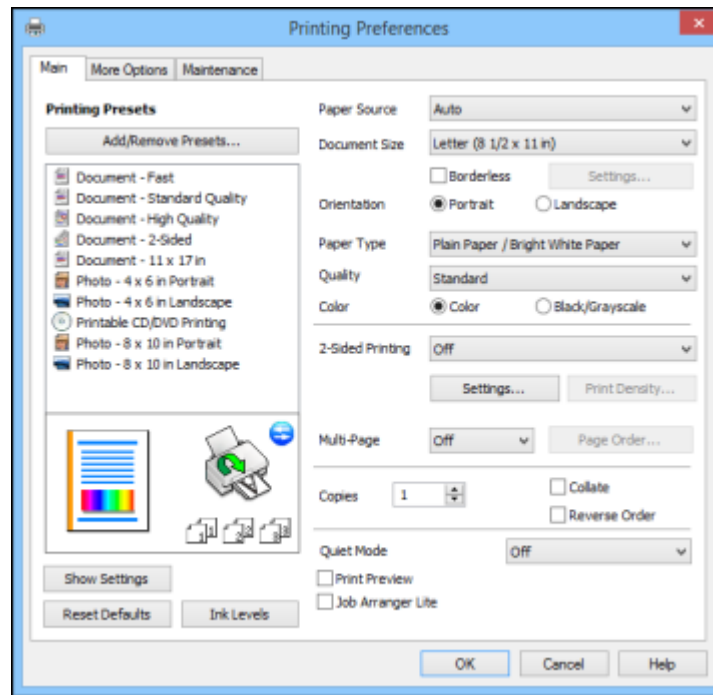

3. Select the print settings you want to use as defaults in all your Windows programs.
4. Click **OK**.

These settings are now the defaults selected for printing. You can still change them as needed for printing in any program session.

#### [Changing the Language of the Printer Software Screens](#)

**Parent topic:** [Printing with Windows](#)

### **Changing the Language of the Printer Software Screens**

You can change the language used on the Windows printer software screens.

1. Access the Windows Desktop and right-click the product icon in the Windows taskbar.
2. Select **Printer Settings**.

You see the printer settings window.

3. Click the **Maintenance** tab.  
You see the maintenance options:

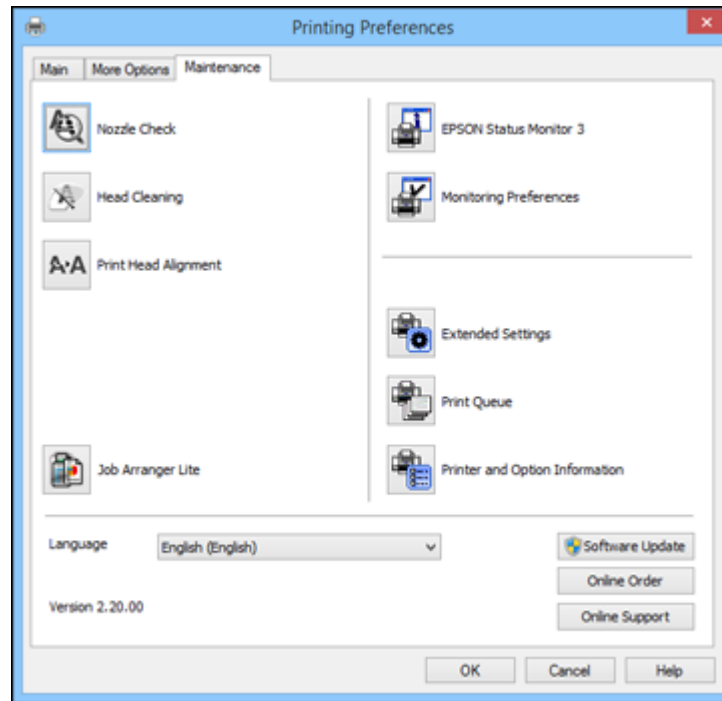

4. Select the language you want to use as the **Language** setting.
5. Click **OK** to close the printer software window.

The printer software screens appear in the language you selected the next time you access them.

**Parent topic:** [Selecting Default Print Settings - Windows](#)

## Changing Automatic Update Options

Your printer software for Windows automatically checks for updates to the product software. You can change how often the software checks for updates or disable this feature.

1. Access the Windows Desktop and right-click the product icon in the Windows taskbar.
2. Select **Software Update Settings**.

You see this window:

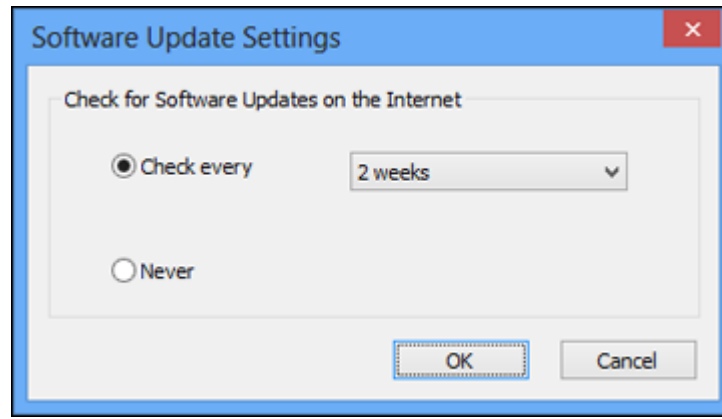

3. Do one of the following:
  - To change how often the software checks for updates, select a setting in the **Check every** menu.
  - To disable the automatic update feature, select the **Never** option.
4. Click **OK** to exit.

**Note:** If you choose to disable the automatic update feature, you can check for updates manually.

**Parent topic:** [Printing with Windows](#)

**Related tasks**

[Checking for Software Updates](#)

## Printing with OS X

You can print with your product using any OS X printing program, as described in these sections.

**Note:** If you have an Internet connection, it is a good idea to check for updates to your product software on Epson's support website.

[Selecting Basic Print Settings - OS X](#)

[Selecting Page Setup Settings - OS X](#)

[Selecting Print Layout Options - OS X](#)

[Selecting Double-sided Printing Settings - OS X](#)

[Managing Color - OS X](#)

[Selecting Printing Preferences - OS X](#)

[Printing Your Document or Photo - OS X](#)

**Parent topic:** [Printing from a Computer](#)

## Selecting Basic Print Settings - OS X

Select the basic settings for the document or photo you want to print.

1. Open a photo or document for printing.
2. Select the print command in your application.

**Note:** You may need to select a print icon on your screen, the **Print** option in the File menu, or another command. See your application's help utility for details.

3. Select your product as the **Printer** setting.

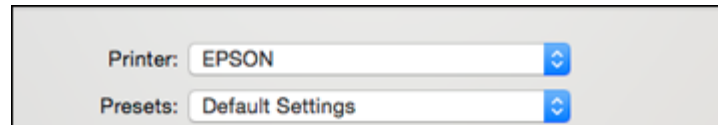

4. If necessary, click the arrow next to the Printer setting or the **Show Details** button to expand the print window.

You see the expanded printer settings window for your product:

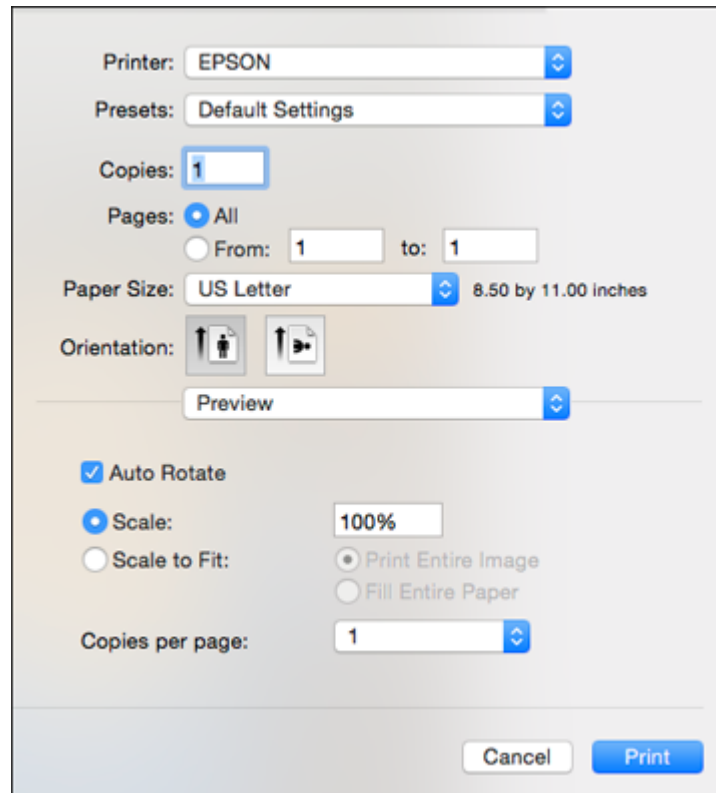

**Note:** The print window may look different, depending on the version of OS X and the application you are using.

5. Select the **Copies** and **Pages** settings as necessary.

**Note:** If you do not see these settings in the print window, check for them in your application before printing.

6. Select the page setup options: **Paper Size** and **Orientation**.

**Note:** If you do not see these settings in the print window, check for them in your application before printing. They may be accessible by selecting **Page Setup** from the File menu.

7. Select any application-specific settings that appear on the screen, such as those shown in the image above for the Preview application.
8. Select **Print Settings** from the pop-up menu.

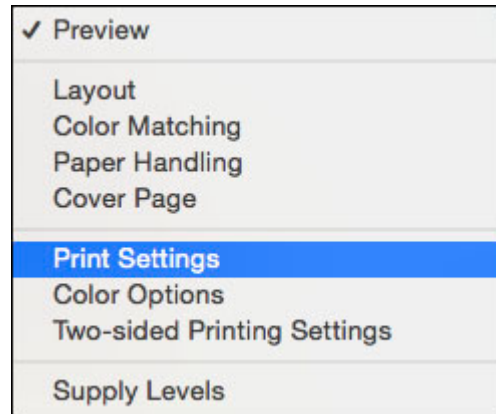

You see these settings:

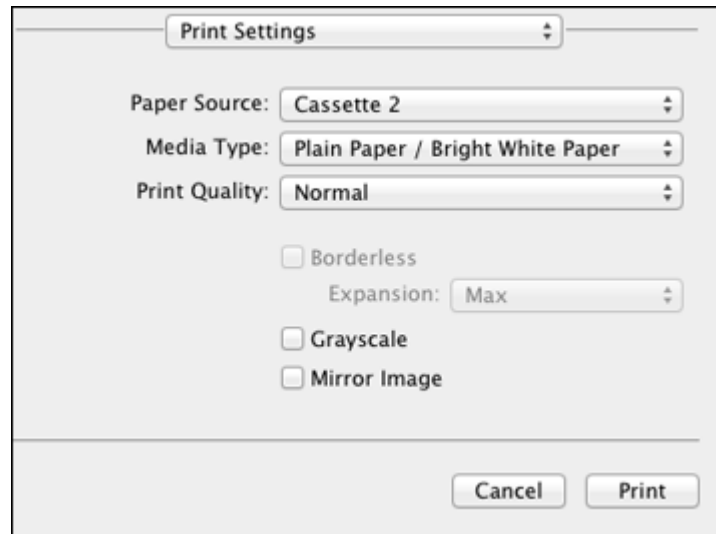

9. Select the **Paper Source** you wish to print from.
10. Select the type of paper you loaded as the **Media Type** setting.

**Note:** The setting may not exactly match the name of your paper. Check the paper type settings list for details.

11. Select the **Print Quality** setting you want to use.
12. Select any of the available print options.

[Paper Source Options - Mac OS X](#)

[Print Quality Settings - OS X](#)

[Print Options - OS X](#)

**Parent topic:** [Printing with OS X](#)

#### **Related references**

[Paper or Media Type Settings - Printer Software](#)

#### **Related tasks**

[Printing Your Document or Photo - Windows](#)

## [Selecting Page Setup Settings - OS X](#)

### **Paper Source Options - Mac OS X**

You can select any of the available options in the Paper Source menu to print from paper loaded in that source.

#### **Cassette 1**

Selects the paper in cassette 1 as the paper source.

#### **Cassette 2**

Selects the paper in cassette 2 as the paper source.

#### **Rear Paper Feed Slot**

Selects the paper in the rear feed slot as the paper source.

**Parent topic:** [Selecting Basic Print Settings - OS X](#)

### **Print Quality Settings - OS X**

You can select any of the print quality settings to fine-tune the quality of your print. Some settings may be unavailable, depending on the paper type and border setting you have chosen.

#### **Draft**

For draft printing on photo paper.

#### **Fast Economy**

For the fastest printing with draft quality.

#### **Economy**

For fast printing with reduced quality.

#### **Normal**

For everyday text and image printing.

#### **Fine**

For text and graphics with good quality and print speed.

#### **Quality**

For photos and graphics with good quality and print speed.

#### **Best Quality**

For the best print quality, but the slowest print speed.

**Parent topic:** [Selecting Basic Print Settings - OS X](#)

### **Print Options - OS X**

You can select any of the print options to customize your print. Some options may be unavailable, depending on other settings you have chosen.

**Expansion**

If you selected a borderless paper size setting, this option adjusts the image expansion settings to control printing at the edges of borderless prints.

**Grayscale**

Prints text and graphics in black or shades of gray.

**Mirror Image**

Lets you flip the printed image horizontally.

**Note:** If you select the **Min** option for the Expansion setting, you may see white borders on your printed photo.

**Parent topic:** [Selecting Basic Print Settings - OS X](#)

## Selecting Page Setup Settings - OS X

Depending on your application, you may be able to select the paper size and orientation settings from the print window.

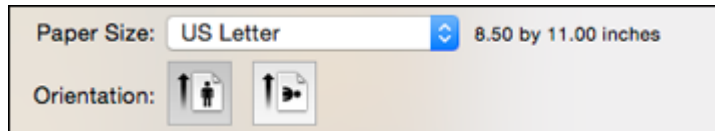

**Note:** If you do not see these settings in the print window, check for them in your application before printing. They may be accessible by selecting **Page Setup** from the File menu.

1. Select the size of the paper you loaded as the **Paper Size** setting. If you are printing a borderless photo, select the **Borderless** checkbox or a paper size with a **Borderless** option. You can also select a custom setting to create a custom paper size, but the Quality setting will be limited to **Normal**.

**Note:** You must select a compatible borderless paper type and size to print without borders. Check the borderless paper compatibility list for details.

2. Select the orientation of your document or photo as shown in the print window.

**Note:** If you are printing an envelope, select the  icon.

**Note:** You can reduce or enlarge the size of the printed image by selecting **Paper Handling** from the pop-up menu and selecting a scaling option.

**Parent topic:** [Printing with OS X](#)

**Related references**

[Borderless Paper Type Compatibility](#)

## Selecting Print Layout Options - OS X

You can select a variety of layout options for your document or photo by selecting **Layout** from the pop-up menu on the print window.

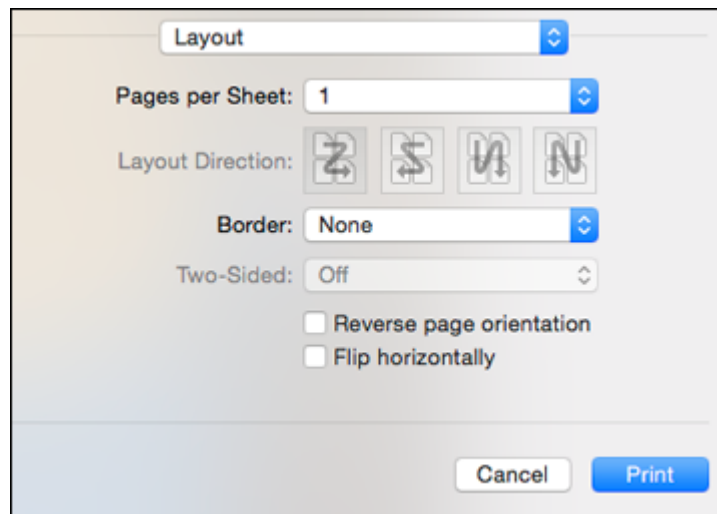

- To print multiple pages on one sheet of paper, select the number of pages in the **Pages per Sheet** pop-up menu. To arrange the print order of the pages, select a **Layout Direction** setting.
- To print borders around each page on the sheet, select a line setting from the **Border** pop-up menu.
- To invert or flip the printed image, select the **Reverse page orientation** or **Flip horizontally** settings.

**Parent topic:** [Printing with OS X](#)

## Selecting Double-sided Printing Settings - OS X

You can print on both sides of the paper by selecting **Two-sided Printing Settings** from the pop-up menu on the print window.

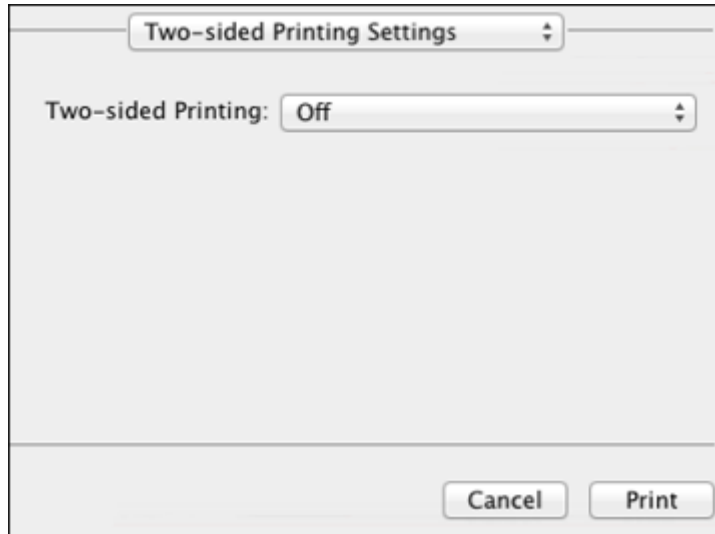

**Note:** Some options may be pre-selected or unavailable, depending on other settings you have chosen or if you are accessing the product over a network. This screen may be different, depending on the version of OS X you are using.

1. Select one of the **Two-sided Printing** options.

2. Select the type of document you are printing as the **Document Type** setting. The software automatically sets the Adjustments options for that document type.

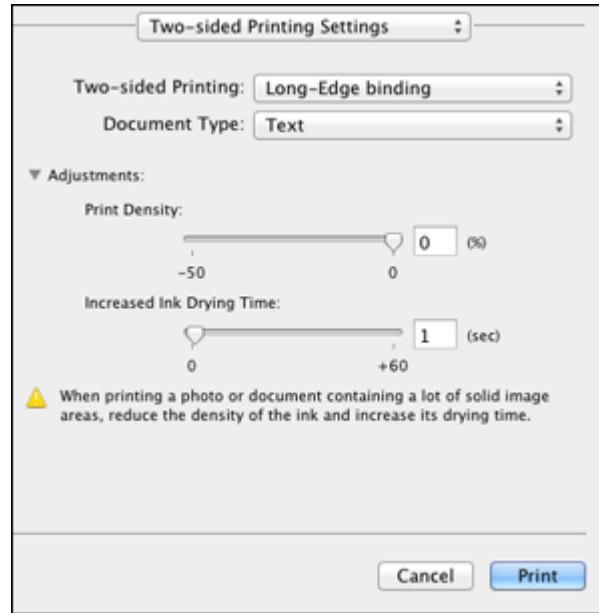

3. If necessary, customize the Adjustments settings as instructed on the screen.
4. Print a test copy of your double-sided document to test the selected settings.
5. Follow any instructions displayed on the screen during printing.

[Double-sided Printing Options and Adjustments - OS X](#)

**Parent topic:** [Printing with OS X](#)

### **Double-sided Printing Options and Adjustments - OS X**

You can select any of the available options in the **Two-sided Printing Settings** or **Output Settings** pop-up menu to set up your double-sided print job.

#### **Two-sided Printing Options**

##### **Long-Edge binding**

Orients double-sided printed pages to be bound on the long edge of the paper.

**Short-Edge binding**

Orients double-sided printed pages to be bound on the short edge of the paper.

**Adjustments****Print Density**

Sets the level of ink coverage for double-sided printing.

**Increased Ink Drying Time**

Sets the amount of time required for drying ink after printing on one side of the paper before printing the other side in double-sided printing.

**Parent topic:** [Selecting Double-sided Printing Settings - OS X](#)

**Managing Color - OS X**

You can adjust the Color Matching and Color Options settings to fine-tune the colors in your printout, or turn off color management in your printer software.

1. Select **Color Matching** from the pop-up menu in the print window.

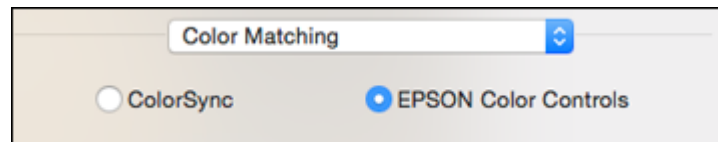

2. Select one of the available options.

3. Select **Color Options** from the pop-up menu in the print window.

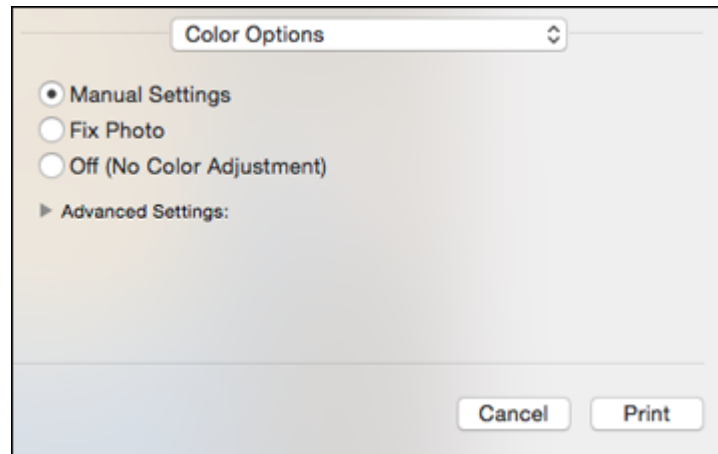

**Note:** The available settings on the Color Options menu depend on the option you selected on the Color Matching menu.

4. Select one of the available options.

[Color Matching and Color Options - OS X](#)

**Parent topic:** [Printing with OS X](#)

### **Color Matching and Color Options - OS X**

You can select from these settings on the **Color Matching** and **Color Options** menus.

#### **Color Matching Settings**

##### **EPSON Color Controls**

Lets you manage color using controls in your printer software or turn off color management.

##### **ColorSync**

Prints using standard color profiles for your product and paper to help match image colors. You can customize the conversion method and filter settings on the ColorSync pop-up menu in the print window.

## Color Options Settings

### Manual Settings

Lets you select manual color adjustments. Click the arrow next to **Advanced Settings** and select settings for **Brightness**, **Contrast**, **Saturation**, and individual color tones. You can also select a color **Mode** setting for printing photos and graphics and the **Fix Red-Eye** setting to reduce or remove red-eye in photos. Depending on the selected color mode, you can also adjust the midtone density using the **Gamma** setting.

### Fix Photo

Improves the color, contrast, and sharpness of flawed photos. Click the arrow next to **Advanced Settings** and select the **Fix Red-Eye** setting to reduce or remove red-eye in photos.

**Note:** Fix Photo uses a sophisticated face recognition technology to optimize photos that include faces. For this to work, both eyes and the nose must be visible in the subject's face. If your photo includes a face with an intentional color cast, such as a statue, you may want to turn off **Fix Photo** to retain the special color effects.

### Off (No Color Adjustment)

Turns off color management in your printer software so you can manage color using only your application software.

**Note:** An ICC profile is required if color management is turned off.

Parent topic: [Managing Color - OS X](#)

## Selecting Printing Preferences - OS X

You can select printing preferences that apply to all the print jobs you send to your product.

1. In the Apple menu or the Dock, select **System Preferences**.
2. Select **Print & Fax**, **Print & Scan**, or **Printers & Scanners**, select your product, and select **Options & Supplies**.
3. Select **Driver** or **Options**.

You see a screen like this:

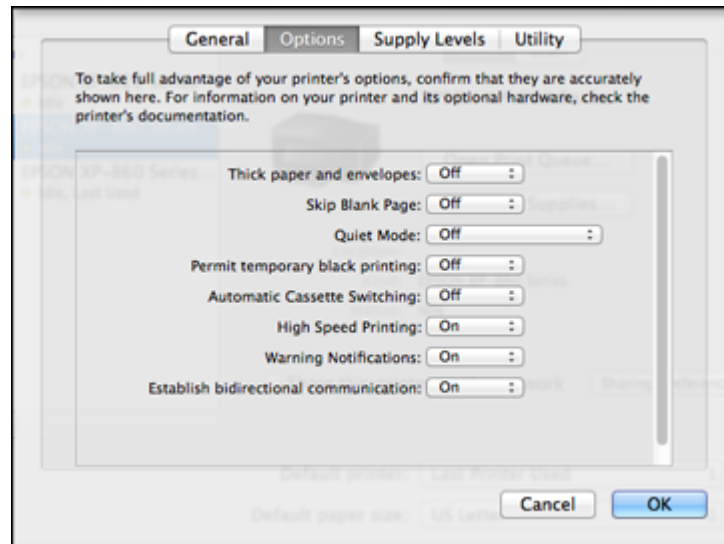

4. Select any of the available printing preferences.
5. Click **OK** or **OK**.

[Printing Preferences - OS X](#)

**Parent topic:** [Printing with OS X](#)

## Printing Preferences - OS X

You can select from these settings on the **Options** or **Driver** tab.

### Thick Paper and Envelopes

Prevents ink from smearing when you print on envelopes or other thick paper.

### Skip Blank Page

Ensures that your product does not print pages that contain no text or images.

### Quiet Mode

Lessens noise during printing but may decrease print speed.

### Permit temporary black printing

Allows you to print using black ink when color ink is expended.

**Automatic Cassette Switching**

Automatically switches to the other cassette when one of the cassettes runs out of paper.

**High Speed Printing**

Speeds up printing but may reduce print quality.

**Warning Notifications**

Lets you choose whether or not to receive warning notifications from the printer software for various operating conditions.

**Establish bidirectional communication**

Allows the product to communicate with the computer. Do not change the default setting unless you experience issues when using a shared printing pool.

Parent topic: [Selecting Printing Preferences - OS X](#)

**Printing Your Document or Photo - OS X**

Once you have selected your print settings, you are ready to print.

Click **Print** at the bottom of the print window.

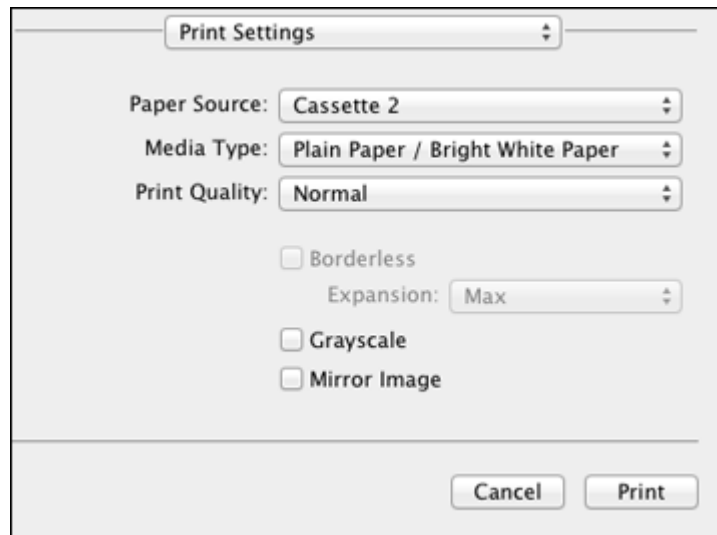

[Checking Print Status - OS X](#)

Parent topic: [Printing with OS X](#)



## Checking Print Status - OS X

During printing, you can view the progress of your print job, control printing, and check ink status.

1. Click the printer icon when it appears in the Dock.

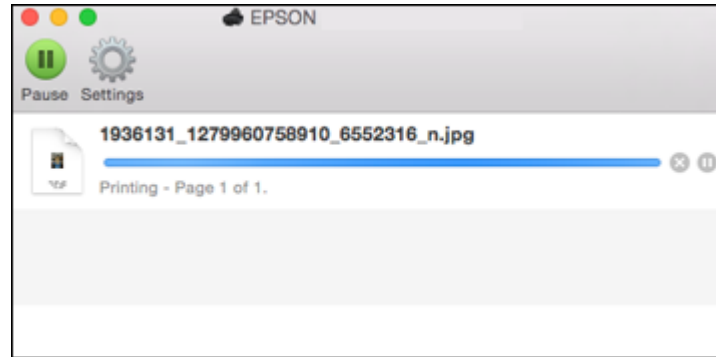
You see the print status window:



2. Select the following options as necessary for your version of OS X:
  - To cancel printing, click the print job and click  or **Delete**.
  - To pause a print job, click the print job and click  or **Hold**. To resume a print job, click the paused print job and click  or **Resume**.
  - To pause printing for all queued print jobs, click **Pause** or **Pause Printer**.
  - To display other printer information, click **Settings** or **Supply Levels**.

**Parent topic:** [Printing Your Document or Photo - OS X](#)

## Cancelling Printing Using a Product Button

If you need to cancel printing, select **Cancel** on the LCD screen.

**Parent topic:** [Printing from a Computer](#)

---

# Scanning

You can scan original documents or photos and save them as digital files.

[Starting a Scan](#)

[Selecting Epson Scan Settings](#)

[Scanning with OS X Using Image Capture](#)

[Scanning Special Projects](#)

## Starting a Scan

After placing your original documents or photos on your product for scanning, start scanning using one of these methods.

[Starting a Scan Using the Product Control Panel](#)

[Starting a Scan Using the Epson Scan Icon](#)

[Starting a Scan from a Scanning Program](#)

**Parent topic:** [Scanning](#)

**Related tasks**

[Placing Originals on the Scanner Glass](#)

## Starting a Scan Using the Product Control Panel

You can scan an image to your computer using your product's touch panel buttons.

Your product automatically selects suitable default scan settings, but you can view or change them as necessary.

1. Make sure you installed the product software and connected the product to your computer or network.

**Note:** Restart your computer after installing the product software to enable scanning from the control panel. Also make sure the Event Manager program is not being blocked by your firewall or security software.

2. Press the  home button, if necessary.
3. Select **Scan**.

The scan options are displayed:

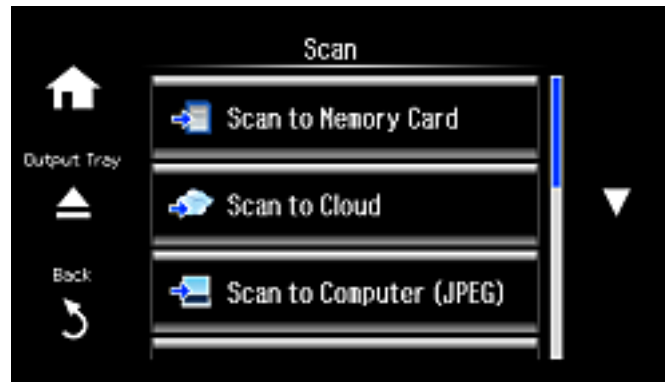

4. Scroll up or down to view additional scan options, then select the one you want.
  - **Scan to Memory Card** saves your scan file on a memory card and lets you select the file format, quality, and other settings.
  - **Scan to Cloud** sends your scanned files to a destination that you have registered with Epson Connect.  
  
**Note:** To use this feature, you must have registered a cloud account with Epson Connect.
  - **Scan to Computer (JPEG)** saves your scan file directly to your computer or as an image capture in OS X .
  - **Scan to Computer (PDF)** saves your scan as a PDF file to your computer or as an image capture in OS X.
  - **Scan to Computer (Email)** scans your original and attaches it to a message in your e-mail program. You can select the e-mail program you want to use and resize your image, if necessary, from an option screen on your computer.  
  
**Note:** This works with MAPI-type email such as Microsoft Outlook, Windows Live Mail, Mac Mail, and Entourage, but not web-based email such as Gmail.
  - **Scan to Computer (WSD)** lets you manage wireless scanning in Windows 8.x, Windows 7, or Windows Vista (English only).

**Note:** To use this feature, you must first set up WSD (Web Services for Devices) on the computer you want to scan to.

5. To scan to your PC, select how you connected your product to your computer:
  - If your product is connected directly to your computer with a USB cable, select **USB Connection**.
  - If your product is connected to your computer over a network, select the computer name from the list.
6. Press the  **Start** button to start scanning.

[Scan to Memory Card Options](#)

[Changing Default Scan Button Settings](#)

**Parent topic:** [Starting a Scan](#)

**Related tasks**

[Using Epson Scan to Cloud](#)

### Scan to Memory Card Options

Select the **Scan to Memory Card** options you want to use.

Scan to Memory Card setting	Available options	Description
<b>JPG</b> <b>PDF</b>	—	<b>JPG:</b> for photos <b>PDF:</b> for documents
<b>Color</b> <b>B&amp;W</b>	—	Select color or black-and-white scans
<b>Contrast</b>	Various levels	Decrease or increase image contrast
<b>Scan Area</b>	<b>Letter</b> <b>A4</b> <b>Auto Cropping</b> <b>Max Area</b>	Selects the page size for documents or special settings for photos. <b>Auto Cropping:</b> for photos with dark edges <b>Max Area:</b> for most photos
<b>Document</b>	<b>Text</b> <b>Photograph</b>	Selects the type of original you are scanning

Scan to Memory Card setting	Available options	Description
Resolution	200 dpi 300 dpi 600 dpi	200 dpi: for e-mailing or posting on the web 300 dpi: for printing or OCR 600 dpi: for highest quality printing
Document Orientation	Portrait Landscape	Specifies the orientation of your originals

Parent topic: [Starting a Scan Using the Product Control Panel](#)

### Changing Default Scan Button Settings

You can view or change the default scan settings your product uses when you scan to your computer using the product buttons. You do this using the Event Manager program.

1. Do one of the following to open Event Manager:
  - **Windows 8.x:** Navigate to the **Apps** screen and select **Event Manager**.
  - **Windows (other versions):** Click  or **Start > All Programs** or **Programs > EPSON Software > Event Manager**.
  - **OS X:** Open the **Applications** folder, click **Epson Software**, and click **Event Manager**.
2. Open the **Scanner** (Windows) or **Select Scanner** (OS X) drop-down list and select your product, if necessary.
3. Click **Make Job Settings**.
4. Open the **Edit Job Settings** drop-down list and select the scan button settings you want to view or change.
5. Change the settings as necessary.
6. Click **OK**.
7. Click **Close** to close the Event Manager window.

Parent topic: [Starting a Scan Using the Product Control Panel](#)

### Starting a Scan Using the Epson Scan Icon

You can start the Epson Scan program to select scan settings, scan, and save the scanned image to a file.

- **Windows 8.x:** Navigate to the **Apps** screen and select **EPSON Scan** under **EPSON** or **EPSON Software**.
- **Windows (other versions):** Click  or **Start**, and select **All Programs** or **Programs**. Select **EPSON** or **EPSON Software** and click **EPSON Scan**.
- **OS X:** Open the **Applications** folder, open the **Epson Software** folder, and double-click the **EPSON Scan** icon.

**Note:** With OS X, in addition to scanning with Image Capture, you can download and install Epson Scan scanning software. Epson Scan provides additional image adjustment and photo correction features for enhancing scanned images, and provides an interface for TWAIN-compliant OCR scanning software. To download Epson Scan, visit Epson's driver download site ([U.S. downloads](#) or [Canadian downloads](#)).

You see an Epson Scan window like this:

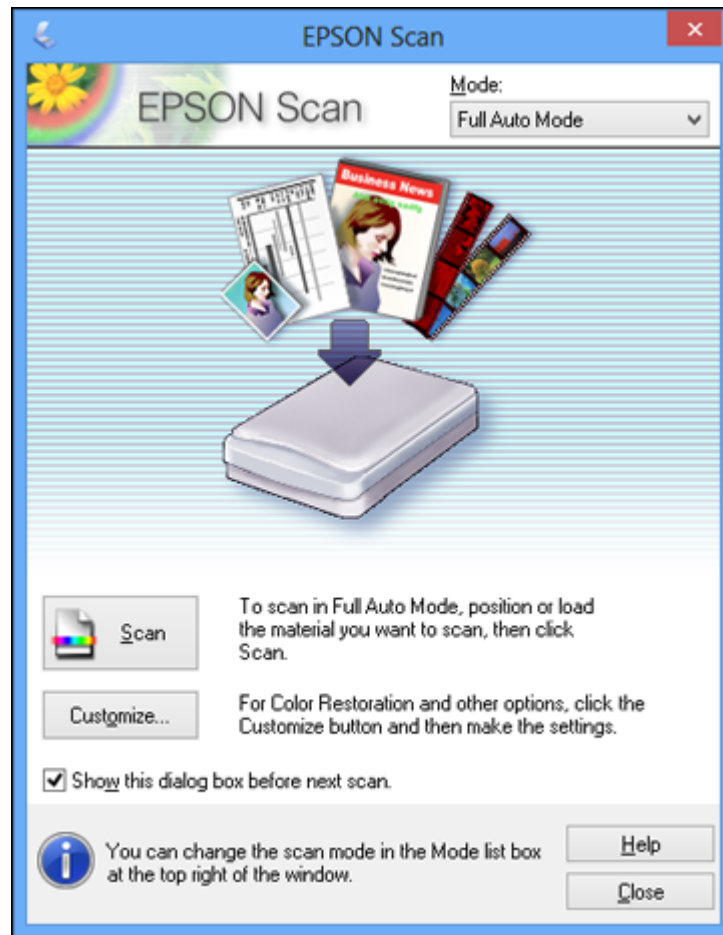

**Parent topic:** [Starting a Scan](#)

**Related tasks**

[Scanning with OS X Using Image Capture](#)

**Related topics**

[Selecting Epson Scan Settings](#)

## **Starting a Scan from a Scanning Program**

You can start Epson Scan from a TWAIN-compliant scanning program to select scan settings, scan, and open the scanned image in the program.

1. Open your scanning program and select its scanning option. (See your scanning program help for instructions.)

2. Select your product.

**Note:** In certain programs, you may need to select your product as the "source" first. If you see a **Select Source** option, choose it and select your product. With Windows, do not select a **WIA** option for your product; it will not work correctly.

You see an Epson Scan window like this:

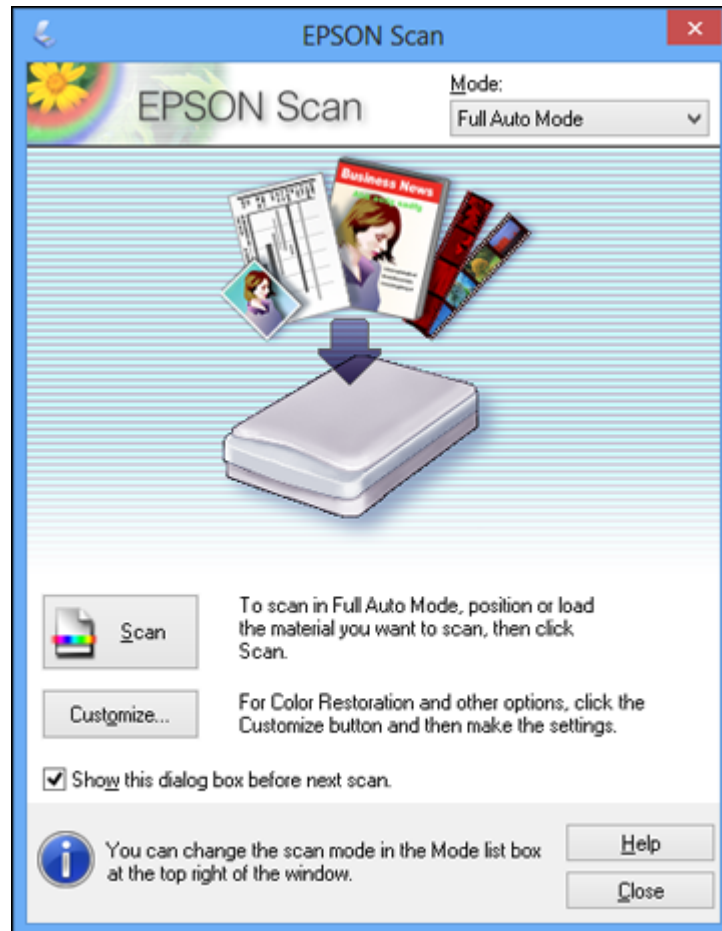

**Note:** In certain programs, you may see the program's scan window instead of the Epson Scan window. Select scanning options as necessary.

**Parent topic:** [Starting a Scan](#)

## Selecting Epson Scan Settings

After starting Epson Scan, you can select settings in various modes to customize your scan.

[Scan Modes](#)

[Selecting the Scan Mode](#)

[Scanning in Full Auto Mode](#)

[Scanning in Home Mode](#)

[Scanning in Office Mode](#)

[Scanning in Professional Mode](#)

[Image Preview Guidelines](#)

[Scan Resolution Guidelines](#)

[Selecting Scan File Settings](#)

**Parent topic:** [Scanning](#)

## Scan Modes

Epson Scan provides a choice of scan modes with different levels of control over your settings.

### **Full Auto Mode**

This mode automatically detects the type of content you are scanning, selects settings for it, and saves your scanned image. You can also select various image adjustment options.

### **Home Mode**

You can select setting groups based on the type of content you are scanning. You can also select various image adjustment options, and preview and size your scanned image.

### **Office Mode**

You can quickly scan text documents and adjust them on a preview screen. You can also select various image adjustment options and preview your scanned image.

### **Professional Mode**

You can manually customize all available settings, and preview and size your scanned image.

**Parent topic:** [Selecting Epson Scan Settings](#)

## Related tasks

[Selecting the Scan Mode](#)

## Selecting the Scan Mode

Select the Epson Scan mode you want to use from the Mode box in the upper right corner of the Epson Scan window:

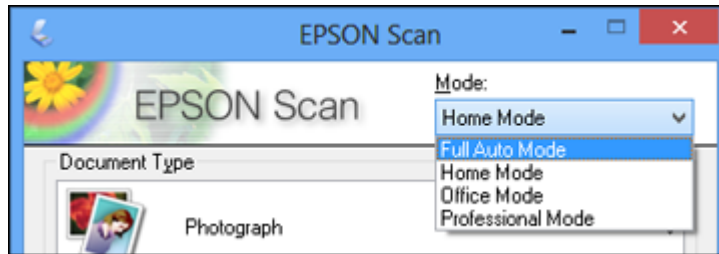

**Parent topic:** [Selecting Epson Scan Settings](#)

## Related tasks

[Scanning in Full Auto Mode](#)

[Scanning in Home Mode](#)

[Scanning in Office Mode](#)

[Scanning in Professional Mode](#)

## Scanning in Full Auto Mode

When you scan in Full Auto Mode, Epson Scan automatically saves your scanned file in JPEG format in your operating system's Pictures or My Pictures folder, or opens it in your scanning program. You can change the scanned file settings and select various image adjustment options before you scan, if necessary.

1. Start Epson Scan and select **Full Auto Mode** as the Mode setting.

You see this window:

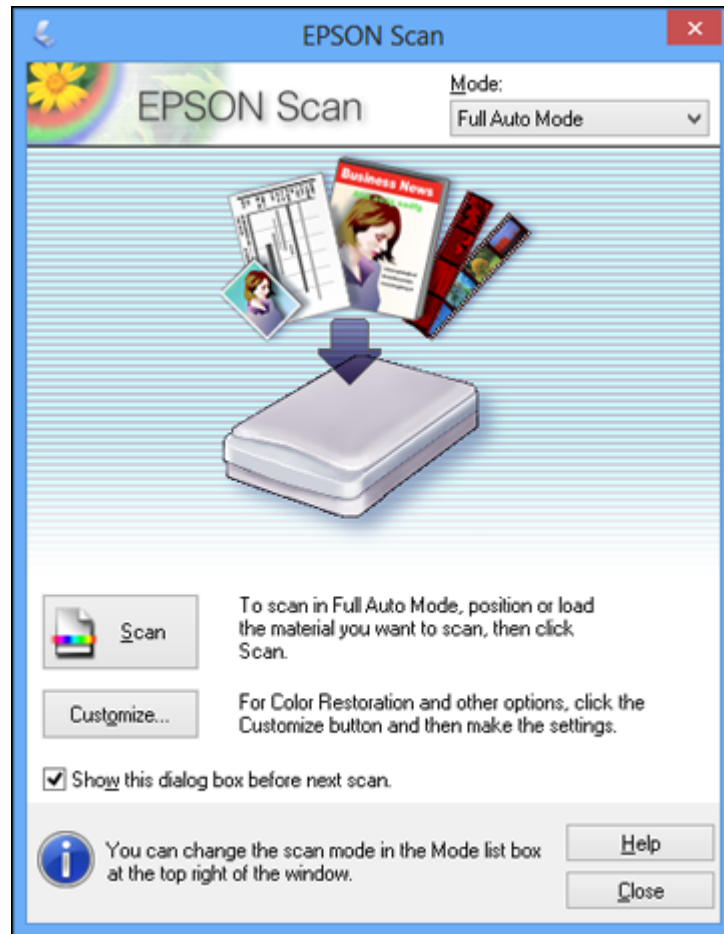

2. To select image adjustment options or change your scanned file settings, click **Customize**, select the settings you want, and click **OK**.

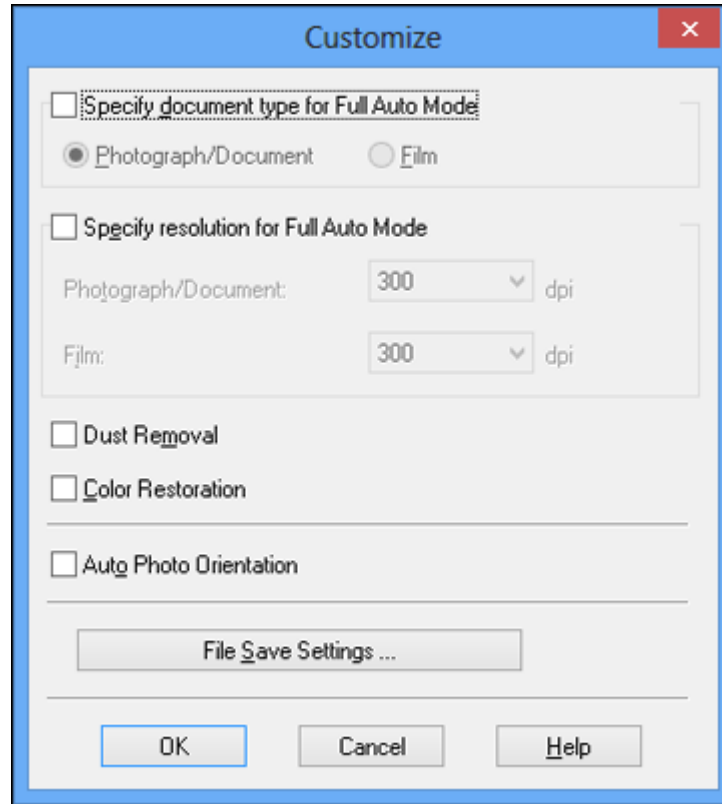

- To choose any of the available image adjustment options, select the checkbox for the option.
- To change the scanned file settings, click **File Save Settings**.

3. Click **Scan**.

Epson Scan scans your original, and saves the file in the selected folder or opens it in your scanning program. If the file was saved directly to your computer, you see the file in the Windows Explorer or OS X Finder, where you can view and print the image, if desired.

[Available Image Adjustments - Full Auto Mode](#)

**Parent topic:** [Selecting Epson Scan Settings](#)

### **Related concepts**

[Scan Resolution Guidelines](#)

### **Related tasks**

[Selecting Scan File Settings](#)

## **Available Image Adjustments - Full Auto Mode**

You can select these image adjustment options in Epson Scan Full Auto Mode.

### **Dust Removal**

Removes dust marks from your originals automatically.

### **Color Restoration**

Restores the colors in faded photos automatically.

### **Auto Photo Orientation**

Checks the preview image for faces, the sky, and other features, and then correctly rotates the photo when it is scanned, if necessary. (If your photo is not oriented correctly using this option, deselect this option and scan again.)

**Parent topic:** [Scanning in Full Auto Mode](#)

## **Scanning in Home Mode**

When you scan in Home Mode, Epson Scan automatically saves your scanned file in JPEG format in your operating system's Pictures or My Pictures folder, or opens it in your scanning program. You can select settings, preview, and change the scanned file settings as necessary.

1. Start Epson Scan and select **Home Mode** as the Mode setting.

You see this window:

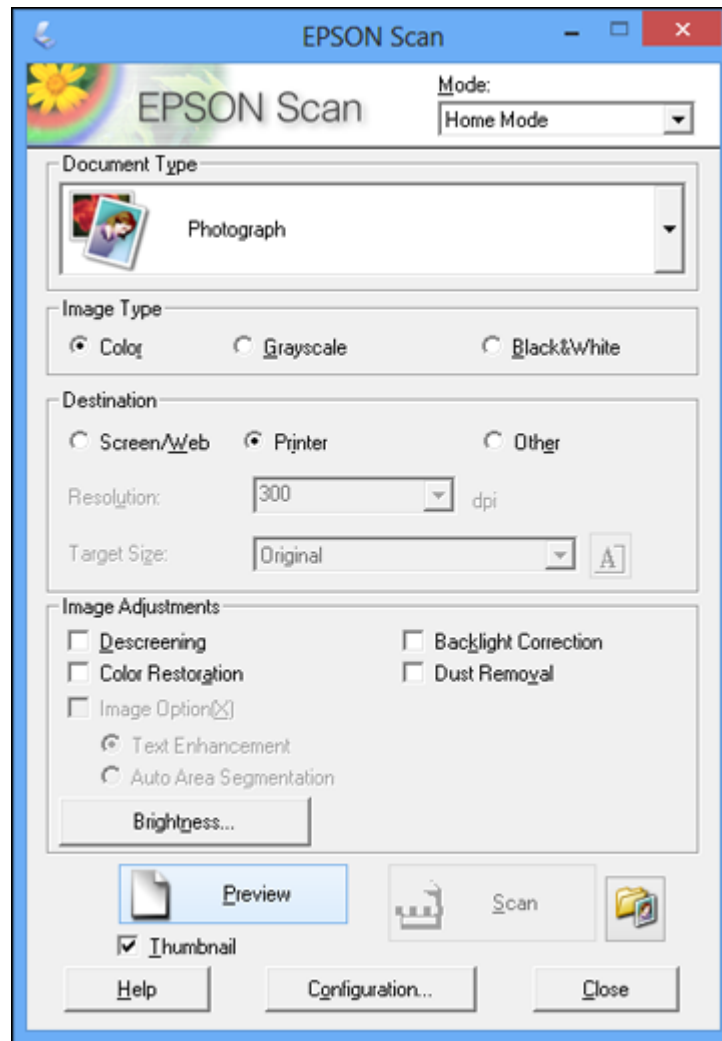

2. Select the **Document Type** setting that matches your original, such as **Photograph** or **Text/Line Art**.
3. Select the **Image Type** setting that matches your original.

4. Select the way you plan to use your scanned image as the **Destination** setting. (The Resolution setting is selected automatically based on the Destination setting you choose.)
  - **Screen/Web**: Select this option for images you will email, view on a computer screen, or post on the web.
  - **Printer**: Select this option for images you will print or documents you will convert to editable text using OCR (Optical Character Recognition) software.
  - **Other**: Select this option if you want to select a custom resolution for your image.
5. If you selected **Other** in the last step, select the **Resolution** setting you want to use for your scan.
6. Click the **Preview** button.

Epson Scan previews your original and displays the result in a separate Preview window.
7. If desired, select the area in your preview image that you want to scan (scan area).
8. Select any of the image adjustment settings you want to use. Before making adjustments, click the image or scan area in the Preview window.
9. If you want to reduce or enlarge your image as you scan, select the **Target Size** setting you want to use.
10. Click **Scan**.

You see the File Save Settings window.
11. Change any of the necessary file save settings and click **OK**.

Epson Scan scans your original, and saves the file in the selected folder or opens it in your scanning program. If the file was saved directly to your computer, you see the file in the Windows Explorer or OS X Finder, where you can view and print the image, if desired.

[Selecting a Scan Area - Home Mode](#)

[Available Image Adjustments - Home Mode](#)

[Selecting a Scan Size - Home Mode](#)

**Parent topic:** [Selecting Epson Scan Settings](#)

#### **Related concepts**

[Image Preview Guidelines](#)

[Scan Resolution Guidelines](#)

#### **Related tasks**

[Selecting Scan File Settings](#)

### **Selecting a Scan Area - Home Mode**

You can select a specific area in your preview image to include in your scanned image. You can select the entire image area or a portion of it. You can even select multiple scan areas to create multiple scanned images of different areas (Normal Preview mode only).

You can also use the scan area to select specific Image Adjustments settings for a scanned image. Just be sure to click inside the scan area before selecting the settings.

1. Do one of the following to select your scan area in the Preview image:

- **Thumbnail preview:** Your scan area is selected automatically, but you can change it. Place your cursor in one corner of the desired scan area, then click and drag the cursor to the opposite corner to create a marquee (dotted line) on the preview image.

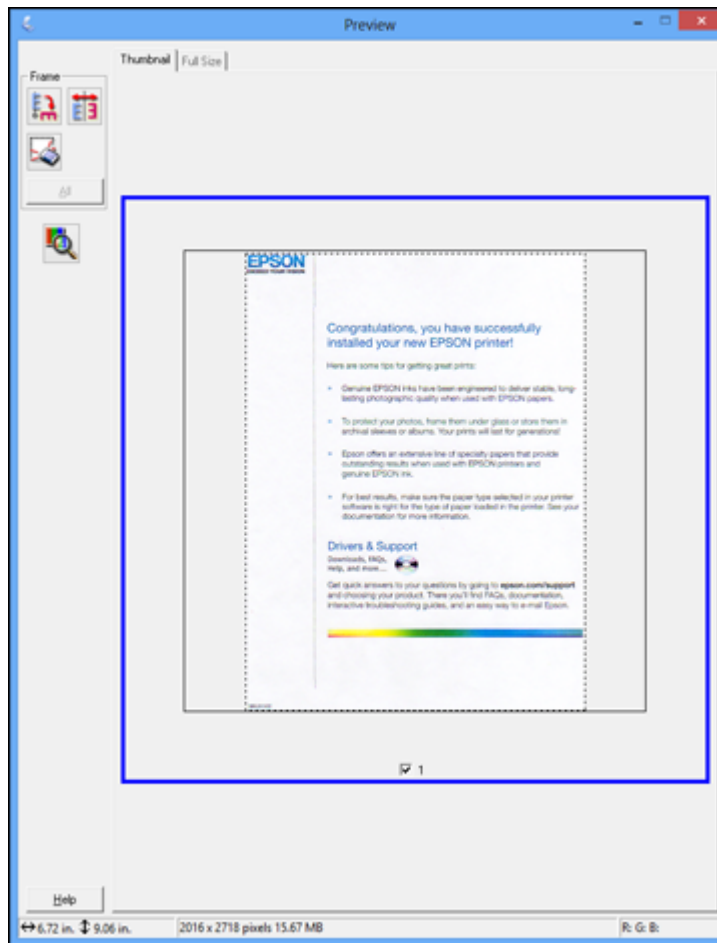

- **Normal preview:** Click the  Auto Locate icon to create a marquee (dotted line) on the preview image.

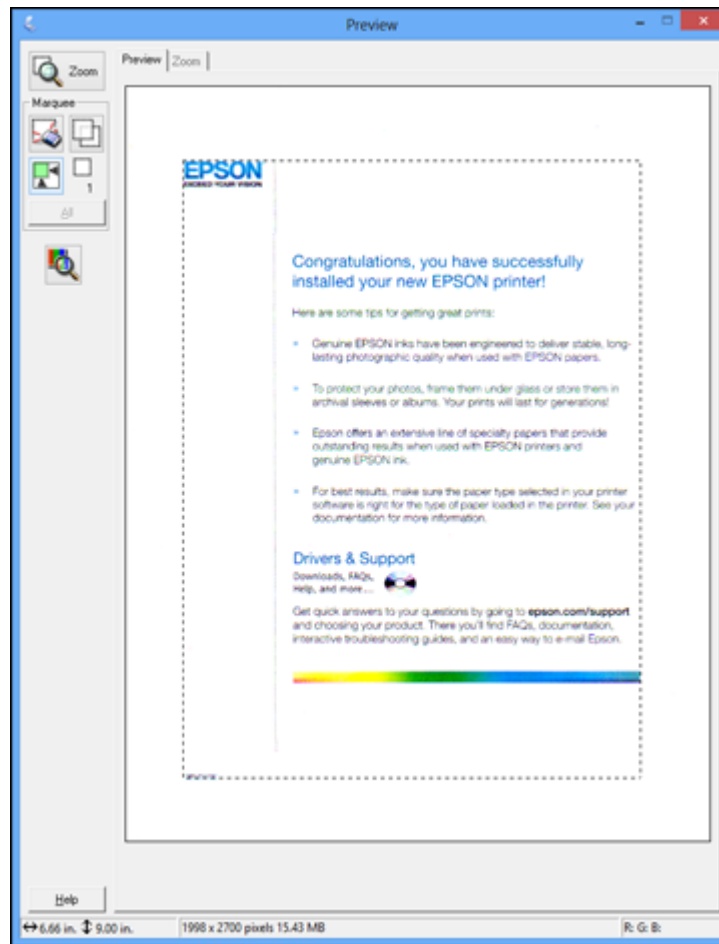

2. Do the following, as necessary, to work with the selected scan area:
  - If the marquee is correct, continue with the next step.
  - To move the marquee, click inside the scan area and drag the marquee where you want it.

- To resize the scan area, place your cursor over the edge or corner of the marquee, then click and drag the edges where you want them. (Hold down the **Shift** key as you resize the marquee to retain the same width/height proportions.)
- **Normal preview:** To create additional marquees (up to 50), click the  Copy Marquee icon to copy the existing marquee and paste it on the preview image.

**Note:** If you draw multiple marquees, make sure you select the **All** button in the Preview window before you scan. Otherwise, only the area inside the currently selected marquee will be scanned.

- To delete a marquee, click the marquee, then click the  Delete Marquee icon.

3. Click inside the scan area and make any necessary settings in the Epson Scan window.

**Parent topic:** [Scanning in Home Mode](#)

### Available Image Adjustments - Home Mode

You can select these Image Adjustments options in Epson Scan Home Mode.

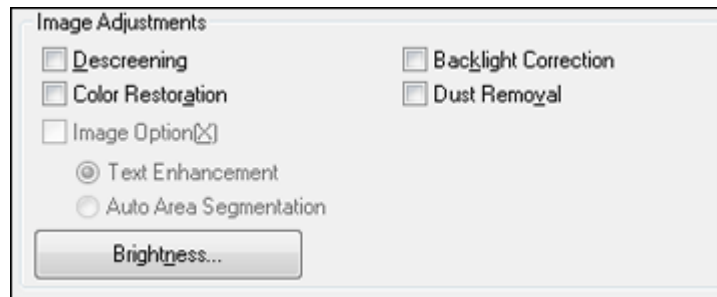

**Note:** Select the **Image Option** checkbox if you need to set any of the grayed-out image adjustments. Not all adjustment settings may be available, depending on the Document Type and Image Type setting. Click the **Brightness** button to access additional settings.

#### Descreening

Removes the ripple pattern that might appear in subtly shaded image areas, such as skin tones. This option improves results when scanning magazines or newspapers. (The results of descreening do not appear in the preview image, only in your scanned image.)

#### Color Restoration

Restores the colors in faded photos automatically.

**Backlight Correction**

Removes shadows from photos that have too much background light.

**Dust Removal**

Removes dust marks from your originals automatically.

**Text Enhancement**

Sharpens the appearance of letters in text documents.

**Auto Area Segmentation**

Makes grayscale images clearer and text recognition more accurate by separating the text from the graphics.

**Brightness**

Adjusts the overall lightness and darkness of the scanned image.

**Contrast**

Adjusts the difference between the light and dark areas of the overall scanned image.

**Threshold**

Adjusts the level at which black areas in text and line art are delineated, improving text recognition in OCR (Optical Character Recognition) programs.

Parent topic: [Scanning in Home Mode](#)

**Selecting a Scan Size - Home Mode**

You can reduce or enlarge the size of your image as you scan. You can also select a specific scan size, such as a common photo size like 4 × 6 inches (102 × 152 mm). This places a scan area of that size on the preview image so you can use it to help crop the image in the correct proportions.

1. Click the **Preview** button to preview your image.
2. In the Epson Scan window, select the size you want your scanned image to be from the **Target Size** list.

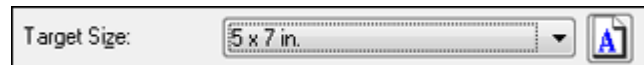

**Note:** If you need to rotate the orientation of the target size for your image, click the  Orientation icon.

A marquee (dotted line) appears on your preview image proportioned for the size you selected.

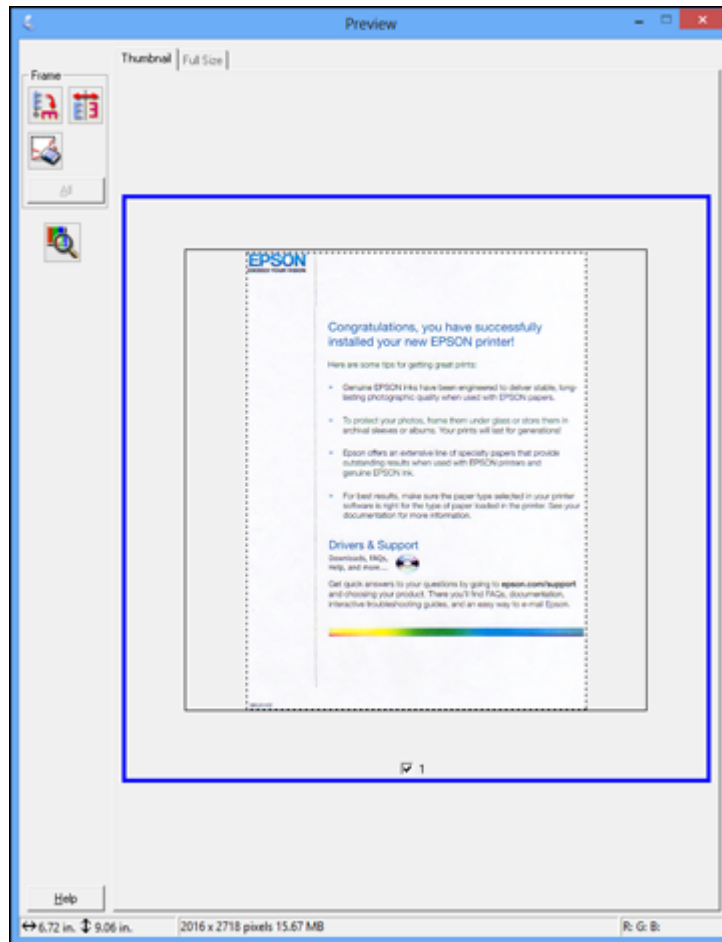

3. Do the following, as necessary, to work with the selected scan area:
  - To move the marquee, click inside the scan area and drag the marquee where you want it.

- To resize the scan area, place your cursor over the edge or corner of the marquee, then click and drag the edge where you want it.

**Note:** Manually adjusting the marquee will not change the target size of the scanned file. The marquee only indicates the area of the image that will be scanned.

4. To create a scanned image size that is not available in the Target Size list, click the **Customize** option.

You see this window:

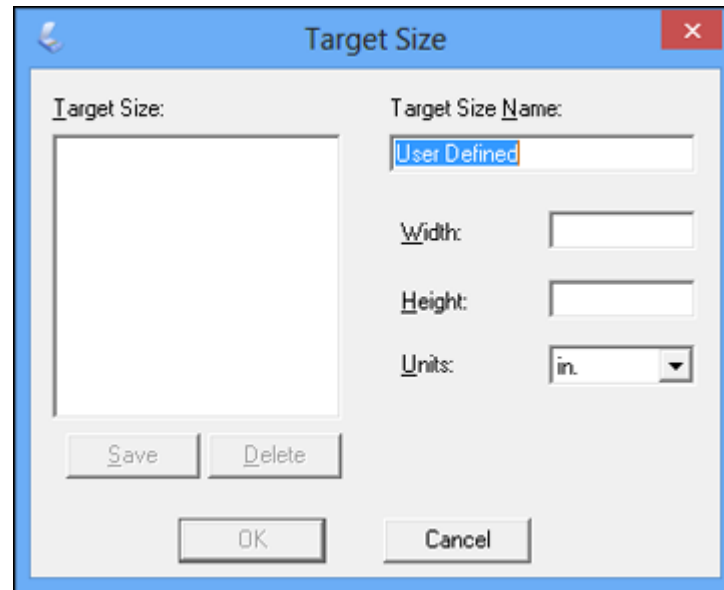

5. Name the custom size, enter the size, click **Save**, and click **OK**. Then adjust the marquee on the preview image.

The marquee is automatically proportioned for your custom scan size.

**Parent topic:** [Scanning in Home Mode](#)

## Scanning in Office Mode

When you scan in Office Mode, Epson Scan automatically saves your scanned file in JPEG format in your operating system's Pictures or My Pictures folder, or opens it in your scanning program. You can select settings, preview, and change the scanned file settings as necessary.

1. Start Epson Scan and select **Office Mode** as the Mode setting.

You see this window:

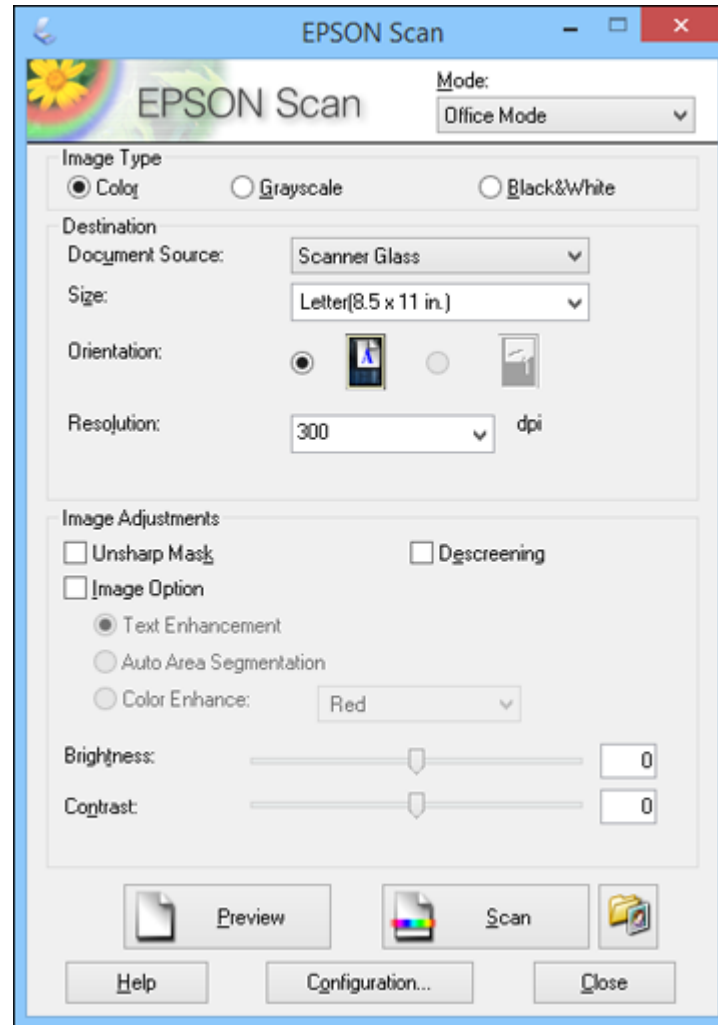

2. Select the **Image Type** setting that matches your original.
3. Select the **Document Source** setting indicating where you placed your original.
4. Select the **Size** and **Orientation** settings that match your original.
5. Select the **Resolution** setting you want to use for your scan.
6. Click the **Preview** button.  
Epson Scan previews your original and displays the result in a separate Preview window.
7. If desired, select the area in your preview image that you want to scan (scan area).
8. Select any of the image adjustment settings you want to use. Before making adjustments, click the image or scan area in the Preview window.
9. Click **Scan**.  
You see the File Save Settings window.
10. Change any of the necessary file save settings and click **OK**.

Epson Scan scans your original, and saves the file in the selected folder or opens it in your scanning program. If the file was saved directly to your computer, you see the file in the Windows Explorer or OS X Finder, where you can view and print the image, if desired.

[Selecting a Scan Area - Office Mode](#)

[Available Image Adjustments - Office Mode](#)

**Parent topic:** [Selecting Epson Scan Settings](#)

**Related concepts**

[Image Preview Guidelines](#)

[Scan Resolution Guidelines](#)

**Related tasks**

[Selecting Scan File Settings](#)

**Selecting a Scan Area - Office Mode**

You can select a specific area in your preview image to include in your scanned image. You can select the entire image area or a portion of it. You can even select multiple scan areas to create multiple scanned images of different areas.

You can also use the scan area to select specific Image Adjustments settings for a scanned image. Just be sure to click inside the scan area before selecting the settings.

1. In the Preview window, click the  Auto Locate icon to create a marquee (dotted line) on the preview image.

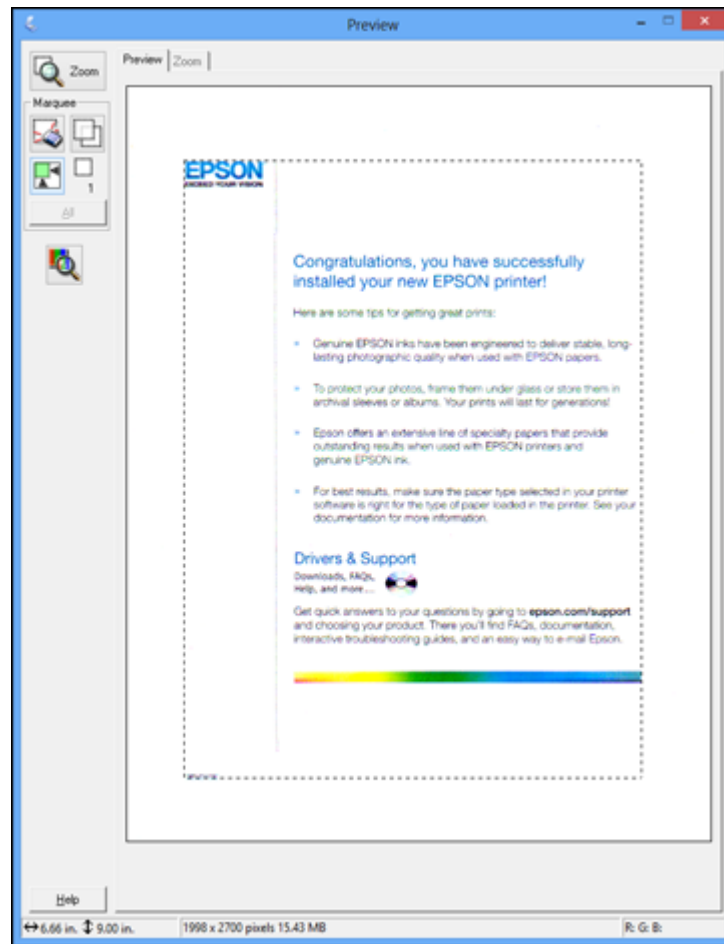

2. Do the following, as necessary, to work with the selected scan area:
  - If the marquee is correct, continue with the next step.
  - To move the marquee, click inside the scan area and drag the marquee where you want it.

- To resize the scan area, place your cursor over the edge or corner of the marquee, then click and drag the edges where you want them. (Hold down the **Shift** key as you resize the marquee to retain the same width/height proportions.)
- To create additional marquees (up to 50, if available), click the  Copy Marquee icon to copy the existing marquee and paste it on the preview image.

**Note:** If you draw multiple marquees, make sure you select the **All** button in the Preview window before you scan. Otherwise, only the area inside the currently selected marquee will be scanned.

- To delete a marquee, click the marquee, then click the  Delete Marquee icon.

3. Click inside each scan area and make any necessary settings in the Epson Scan window.

**Parent topic:** [Scanning in Office Mode](#)

### Available Image Adjustments - Office Mode

You can select these Image Adjustments options in Epson Scan Office Mode. Not all adjustment settings may be available, depending on other settings you have chosen.

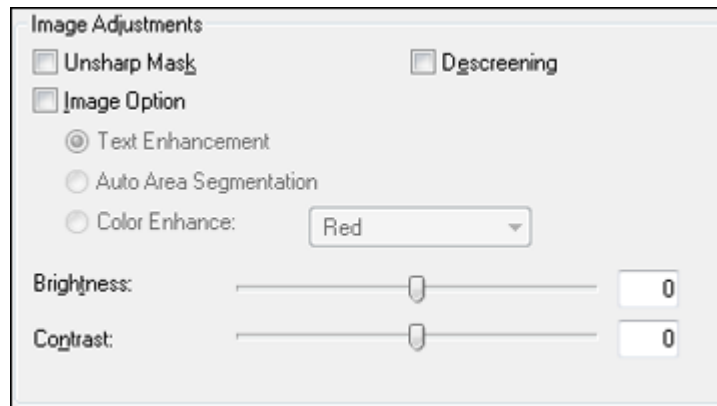

**Note:** Select the **Image Option** checkbox if you need to set any of the grayed-out image adjustments beneath the checkbox. Not all adjustment settings may be available, depending on the Image Type setting.

#### Unsharp Mask

Makes the edges of certain image areas clearer. Turn off this option to leave softer edges.

**Descreening**

Removes the ripple pattern that might appear in subtly shaded image areas, such as skin tones. This option improves results when scanning magazines or newspapers. (The results of descreening do not appear in the preview image, only in your scanned image.)

**Text Enhancement**

Sharpens the appearance of letters in text documents.

**Auto Area Segmentation**

Makes grayscale images clearer and text recognition more accurate by separating the text from the graphics.

**Color Enhance**

Enhances the red, green, or blue shades in the scanned image.

**Brightness**

Adjusts the overall lightness and darkness of the scanned image.

**Contrast**

Adjusts the difference between the light and dark areas of the overall scanned image.

**Threshold**

Adjusts the level at which black areas in text and line art are delineated, improving text recognition in OCR (Optical Character Recognition) programs.

Parent topic: [Scanning in Office Mode](#)

## Scanning in Professional Mode

When you scan in Professional Mode, Epson Scan automatically saves your scanned file in JPEG format in your operating system's Pictures or My Pictures folder, or opens it in your scanning program. You can select settings, preview, and change the scanned file settings as necessary.

1. Start Epson Scan and select **Professional Mode** as the Mode setting.

You see this window:

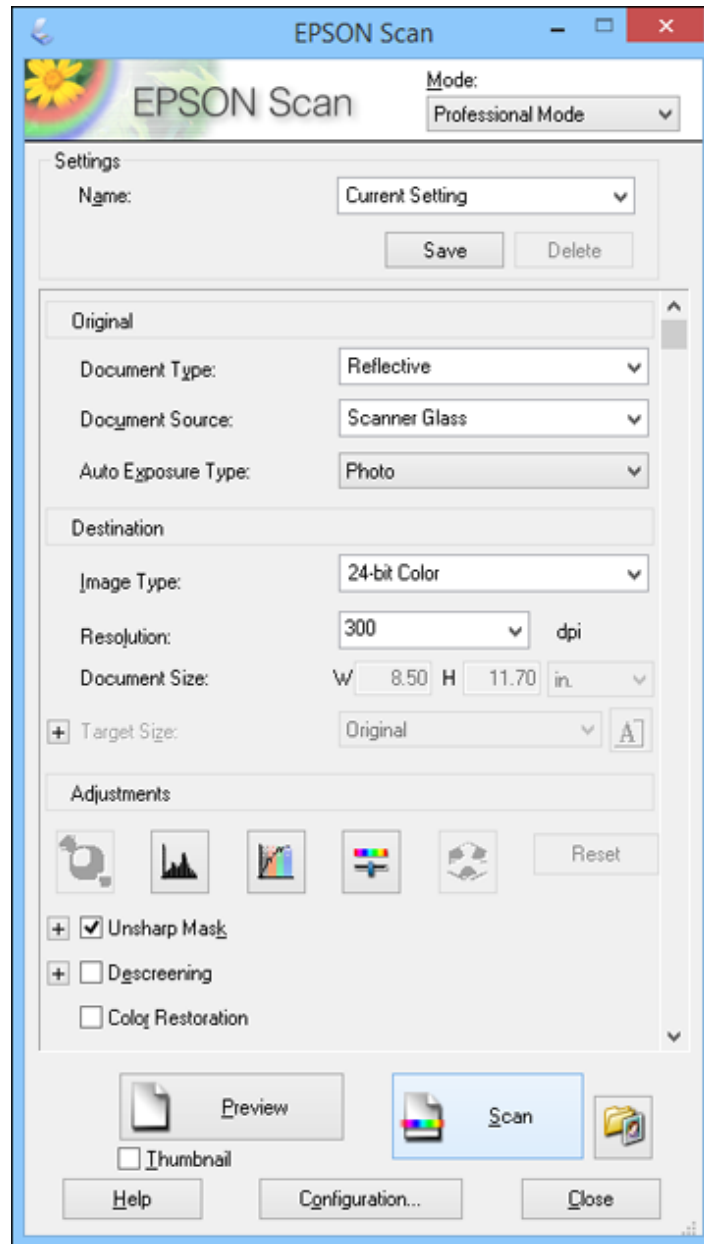

2. Select the **Document Type** setting that matches your original, such as **Reflective** for documents or photos.
3. Select the **Document Source** setting indicating where you placed your original.
4. Select the specific type of original you are scanning as the **Auto Exposure Type** setting: **Document** or **Photo**.
5. Select the details of your original and how you want it scanned as the **Image Type** setting.
6. Select the **Resolution** setting you want to use for your scan.
7. Click the **Preview** button.

Epson Scan previews your original and displays the result in a separate Preview window.

8. If desired, select the area in your preview image that you want to scan (scan area).
9. Select any of the image adjustment settings you want to use. Before making adjustments, click the image or scan area in the Preview window.
10. If you want to reduce or enlarge your image as you scan, select the **Target Size** setting you want to use.
11. Click **Scan**.

You see the File Save Settings window.

12. Change any of the necessary file save settings and click **OK**.

Epson Scan scans your original, and saves the file in the selected folder or opens it in your scanning program. If the file was saved directly to your computer, you see the file in the Windows Explorer or OS X Finder, where you can view and print the image, if desired.

[Available Image Types - Professional Mode](#)

[Selecting a Scan Area - Professional Mode](#)

[Available Image Adjustments - Professional Mode](#)

[Selecting a Scan Size - Professional Mode](#)

**Parent topic:** [Selecting Epson Scan Settings](#)

#### **Related concepts**

[Image Preview Guidelines](#)

[Scan Resolution Guidelines](#)

#### **Related tasks**

[Selecting Scan File Settings](#)

## Available Image Types - Professional Mode

You can select these Image Type options in Epson Scan Professional Mode.

### **24-bit Color**

Select this setting for color photos.

### **Color Smoothing**

Select this setting for color graphic images, such as charts or graphs.

### **8-bit Grayscale**

Select this setting for black-and-white photos.

### **Black & White**

Select this setting for black text documents or line art.

**Parent topic:** [Scanning in Professional Mode](#)

## Selecting a Scan Area - Professional Mode

You can select a specific area in your preview image to include in your scanned image. You can select the entire image area or a portion of it. You can even select multiple scan areas to create multiple scanned images of different areas (Normal Preview mode only).

You can also use the scan area to select specific image Adjustments settings for a scanned image. Just be sure to click inside the scan area before selecting the settings.

**Note:** In Professional Mode, the default Preview mode is Normal Preview mode. To use Thumbnail Preview mode instead, select the **Thumbnail** checkbox beneath the Preview button (if available), then click the **Preview** button to preview your image again.

1. Do one of the following to select your scan area in the Preview image:

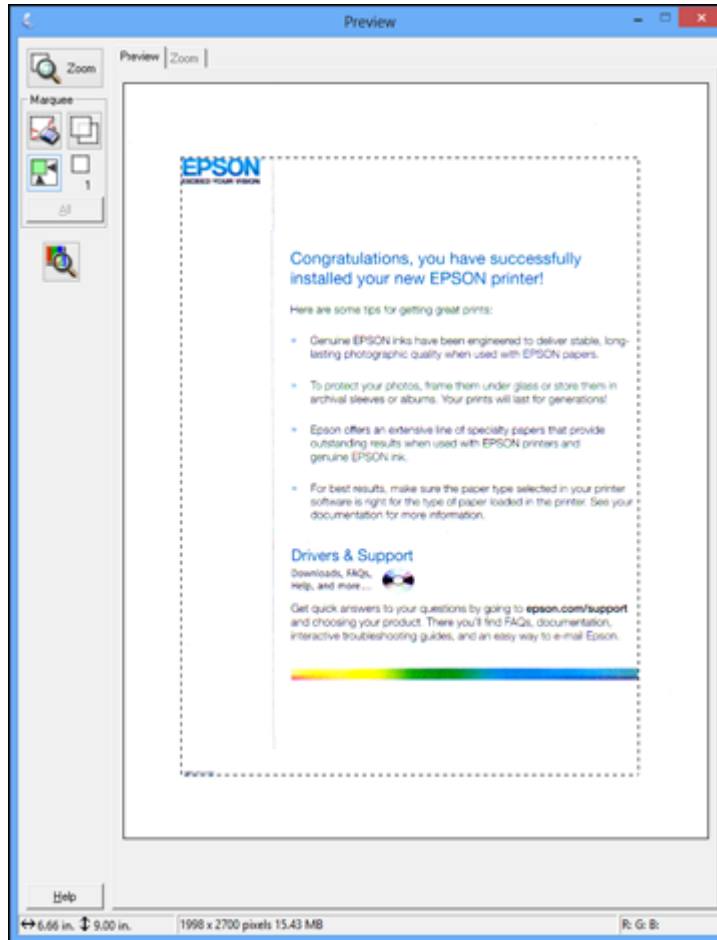

- **Normal preview:** Click the  Auto Locate icon to create a marquee (dotted line) on the preview image.

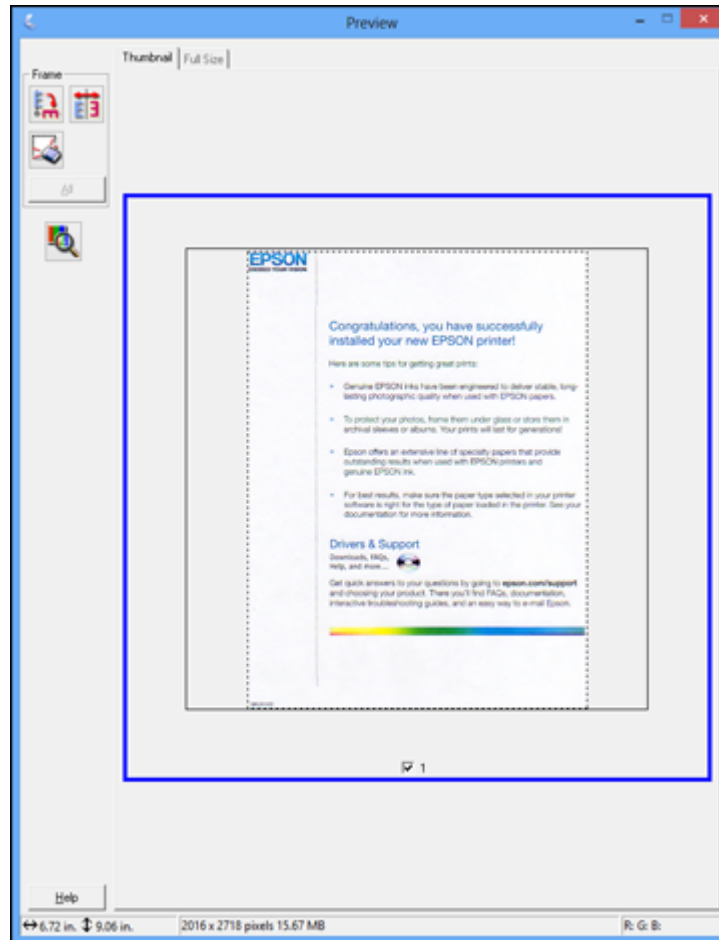

- **Thumbnail preview:** Your scan area is selected automatically, but you can change it. Place your cursor in one corner of the desired scan area, then click and drag the cursor to the opposite corner to create a marquee (dotted line) on the preview image.



2. Do the following, as necessary, to work with the selected scan area:
  - If the marquee is correct, continue with the next step.
  - To move the marquee, click inside the scan area and drag the marquee where you want it.

- To resize the scan area, place your cursor over the edge or corner of the marquee, then click and drag the edges where you want them. (Hold down the **Shift** key as you resize the marquee to retain the same width/height proportions.)
- **Normal preview:** To create additional marquees (up to 50, if available), click the  Copy Marquee icon to copy the existing marquee and paste it on the preview image.
- To delete a marquee, click the marquee, then click the  Delete Marquee icon.

**Note:** If you draw multiple marquees, make sure you select the **All** button in the Preview window before you scan. Otherwise, only the area inside the currently selected marquee will be scanned.

3. Click inside the scan area and make any necessary settings in the Epson Scan window.

**Parent topic:** [Scanning in Professional Mode](#)

### Available Image Adjustments - Professional Mode

You can select these Adjustments options in Epson Scan Professional Mode. Not all adjustment settings may be available, depending on other settings you have chosen.

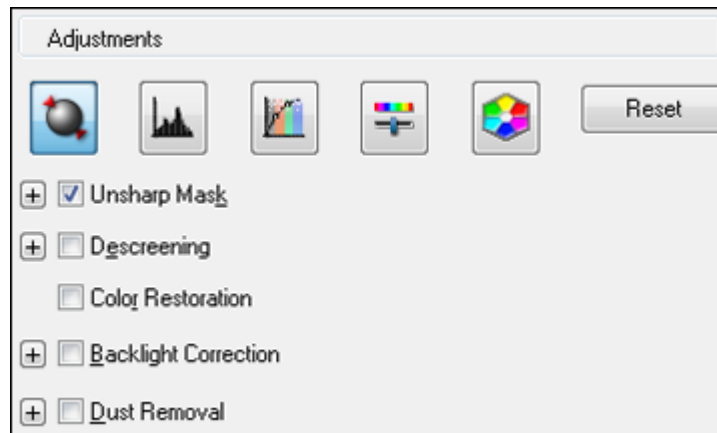

Click the  image adjustment icon to access additional settings.

Click the **+** (Windows) or **▶** (OS X) icon next to a setting to change the level of adjustment.

#### Unsharp Mask

Makes the edges of certain image areas clearer. Turn off this option to leave softer edges.

**Descreening**

Removes the ripple pattern that might appear in subtly shaded image areas, such as skin tones. This option improves results when scanning magazines or newspapers. (The results of descreening do not appear in the preview image, only in your scanned image.)

**Color Restoration**

Restores the colors in faded photos automatically.

**Backlight Correction**

Removes shadows from photos that have too much background light.

**Dust Removal**

Removes dust marks from your originals automatically.

**Auto Exposure**

Automatically adjusts the image exposure settings when you click the  Auto Exposure icon. To automatically adjust image exposure settings continuously, click the **Configuration** button, click the **Color** tab, and select **Continuous auto exposure**. You can adjust the level of auto exposure using a slider.

**Histogram Adjustment**

Provides a graphical interface for adjusting highlight, shadow, and gamma levels individually. (For advanced users only.) Click the  histogram icon to access the settings.

**Tone Correction**

Provides a graphical interface for adjusting tone levels individually. (For advanced users only.) Click the  tone correction icon to access the settings.

**Brightness**

Adjusts the overall lightness and darkness of the scanned image.

**Contrast**

Adjusts the difference between the light and dark areas of the overall scanned image.

**Saturation**

Adjusts the density of colors in the overall image.

**Color Balance**

Adjusts the balance of colors in the overall image.

**Color Palette**

Provides a graphical interface for adjusting mid-tone levels, such as skin tones, without affecting the highlight and shadow areas of the image. (For advanced users only.) Click the  Color Palette icon to access the settings.

### Threshold

Adjusts the level at which black areas in text and line art are delineated, improving text recognition in OCR (Optical Character Recognition) programs.

**Parent topic:** [Scanning in Professional Mode](#)

### Selecting a Scan Size - Professional Mode

You can reduce or enlarge the size of your image as you scan. You can also select a specific scan size, such as a common photo size like 4 × 6 inches (102 × 152 mm). This places a scan area of that size on the preview image so you can use it to help crop the image in the correct proportions.

1. Click the **Preview** button to preview your image.
2. In the Epson Scan window, select the size you want your scanned image to be from the **Target Size** list.

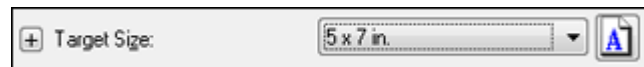

**Note:** If you need to rotate the orientation of the target size for your image, click the  orientation icon.

A marquee (dotted line) appears on your preview image proportioned for the size you selected.

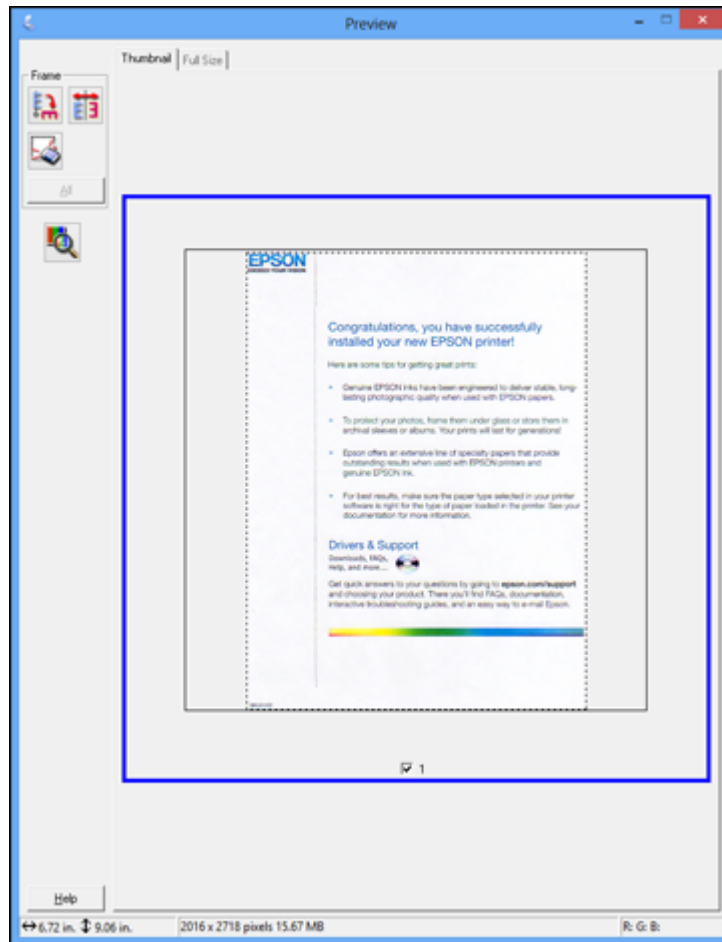

3. Do the following, as necessary, to work with the selected scan area:
  - To move the marquee, click inside the scan area and drag the marquee where you want it.

- To resize the scan area, place your cursor over the edge or corner of the marquee, then click and drag the edge where you want it.

**Note:** Manually adjusting the marquee will not change the target size of the scanned file. The marquee only indicates the area of the image that will be scanned.

4. To create a scanned image size that is not available in the Target Size list, click the **Customize** option.

You see this window:

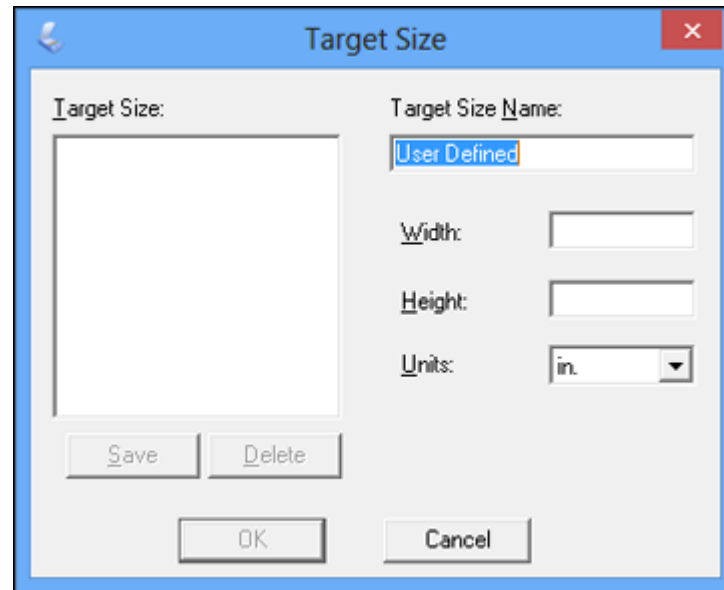

5. Name the custom size, enter the size, click **Save**, and click **OK**. Then adjust the marquee on the preview image.

The marquee is automatically proportioned for your custom scan size.

- To use additional sizing tools, click the + (Windows) or ► (OS X) icon next to the Target Size setting and select options as desired.

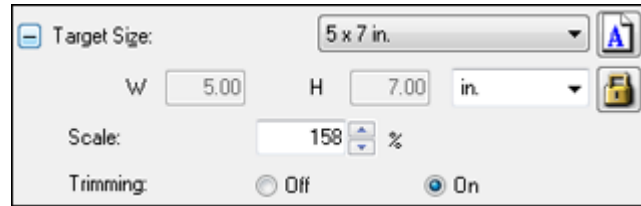

- **Scale:** Reduces or enlarges your image by the percentage you enter.
- **Trimming:** Turns automatic image cropping on or off.
-  **Unlock icon:** Unlocks the width/height proportions of the scanned image size so you can adjust it without constraint.

Parent topic: [Scanning in Professional Mode](#)

## Image Preview Guidelines

You can preview your scanned image so you can adjust the scan settings using the preview as a guide. There are two types of preview available, depending on the scan mode and selected settings:

### Thumbnail preview

A thumbnail preview displays your previewed images as thumbnails with the scanned image area and exposure automatically selected. If the **Thumbnail** checkbox is selected, clicking the **Preview** button opens a thumbnail preview.

### Normal preview

A normal preview displays your previewed images in their entirety so you can select the scanned image area and other settings manually. If the **Thumbnail** checkbox is deselected, clicking the **Preview** button opens a normal preview.

Parent topic: [Selecting Epson Scan Settings](#)

## Scan Resolution Guidelines

If you plan to enlarge a scanned image so you can print it at a larger size, you may need to increase the resolution from the default resolution set by Epson Scan. Follow these guidelines to determine the resolution setting you need:

- You will enlarge the image as you scan it.

If you will enlarge the image using Epson Scan's Target Size setting, you do not need to increase the Resolution setting.

- You will scan the image at its original size but enlarge it later in an image-editing program.

Increase Epson Scan's Resolution setting in your scan. Increase the resolution by the same amount you will increase the image size to retain a high image quality. For example, if the resolution is 300 dpi (dots per inch) and you will double the image size later, change the Resolution setting to 600 dpi.

- You will scan the image at 100% or smaller size.

Select Epson Scan's Resolution setting based on how you will use the scanned image:

- Email/view on a computer screen/post on the web: 96 to 150 dpi
- Print/convert to editable text (OCR): 300 dpi
- Fax: 200 dpi

**Parent topic:** [Selecting Epson Scan Settings](#)

## Selecting Scan File Settings

You can select the location, name, and format of your scan file on the File Save Settings window. You can also select various optional settings that control how Epson Scan behaves when you scan and save files.

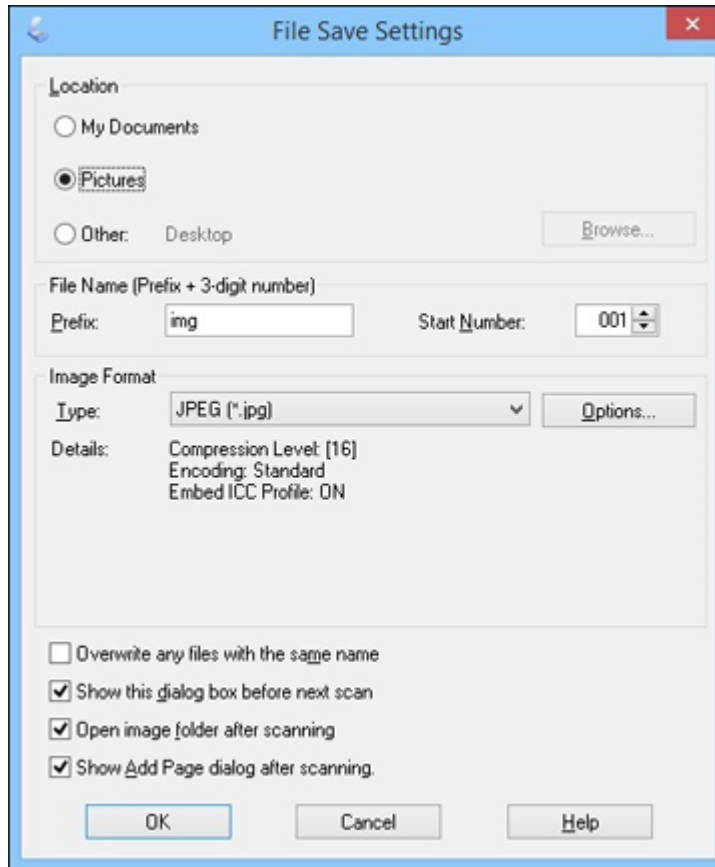

The File Save Settings window may appear after you click **Scan** on the Epson Scan window. You may also be able to access the window by clicking the  icon on the Epson Scan window.

1. Do one of the following to select the folder in which you want to save your scanned image:
  - Click the button for one of the displayed folders.

- Click the **Other** button, click the **Browse** or **Choose** button, and select a folder.
- 2. Type in a file name in the **Prefix** field. This name is used along with numbers to automatically name your scanned files.
- 3. Select a different number as the **Start Number** setting, if you like.
- 4. Select the file format you want to use in the Image Format **Type** menu.
- 5. If your file format provides optional settings, click the **Options** button to select them.
- 6. Choose any of the optional settings you want to use by selecting their checkboxes.
- 7. Click **OK**.

[Available Scanned File Types and Optional Settings](#)

**Parent topic:** [Selecting Epson Scan Settings](#)

### **Available Scanned File Types and Optional Settings**

You can select from a variety of scanned file types and optional settings on the File Save Settings window in Epson Scan.

#### **File Formats**

##### **Bitmap (\*.bmp)**

A standard image file format for most Windows programs.

##### **JPEG (\*.jpg)**

An image format that lets you highly compress image data. However, the higher the compression, the lower the image quality. (The TIFF format is recommended when you need to modify or retouch your scanned image.)

##### **Multi-TIFF (\*.tif)**

A TIFF file format when multiple pages are saved to the same file, allowing you to edit the images using a compatible program.

##### **PDF (\*.pdf)**

A document format that is readable by Windows and OS X systems using Adobe Reader, Acrobat, or other programs. You can save multi-page documents in one PDF file.

##### **PICT (\*.pct)**

A standard image file format for most OS X programs.

##### **PRINT Image Matching II (\*.jpg or \*.tif)**

File formats that include Epson PRINT Image Matching II data for enhanced quality and a wider color range (does not affect the way the image displays on the screen).

**TIFF (\*.tif)**

A file format created for exchanging data between many programs, such as graphic and DTP software.

**Optional Settings****Overwrite any files with the same name**

Select to overwrite previous files with the same names.

**Show this dialog box before next scan**

Select to have the File Save Settings window appear automatically before you scan (in certain Epson Scan modes).

**Open image folder after scanning**

Select to have Windows Explorer or OS X Finder automatically open to the folder where your scanned image is saved after scanning.

**Show Add Page dialog after scanning**

If you are scanning a multi-page document using the PDF or Multi-TIFF format, select to display a prompt for scanning additional pages after the first page is scanned.

Parent topic: [Selecting Scan File Settings](#)

## Scanning with OS X Using Image Capture

With OS X, you can scan with your product using an image-editing application such as Image Capture.

**Note:** With OS X, in addition to scanning with Image Capture, you can download and install Epson Scan scanning software. Epson Scan provides additional image adjustment and photo correction features for enhancing scanned images, and provides an interface for TWAIN-compliant OCR scanning software. To download Epson Scan, visit Epson's driver download site ([U.S. downloads](#) or [Canadian downloads](#)).

1. Open an image editing application, such as Image Capture.
2. Select your Epson product from the **DEVICES** or **SHARED** list in the Finder, if necessary. (You may need to hover over the **DEVICES** or **SHARED** list, click **Show**, and select your product.)
3. If you see the **Show Details** button, click it.

If you are scanning an item on the scanner glass, your product begins a preview scan.

4. Select the **Scan Mode** setting indicating where you placed your original (if available). Select any other available scan settings as necessary.

The image shows a settings dialog box for a scanner. It is organized into several sections separated by horizontal lines. The first section contains 'Kind' (Color), 'Resolution' (50 dpi), 'Use Custom Size' (checked), 'Size' (0 x 0 inches), 'Rotation Angle' (0°), and 'Auto Selection' (Detect Separate Items). The second section contains 'Scan To' (Pictures), 'Name' (Scan), and 'Format' (JPEG). The third section contains 'Image Correction' (None). The fourth section contains 'Unsharp Mask' (None), 'Descreening' (None), 'Backlight Correction' (None), and 'Dust Removal' (None). There is also an unchecked 'Color Restoration' checkbox. At the bottom, there are three buttons: 'Hide Details', 'Overview', and 'Scan'.

Kind: Color

Resolution: 50 dpi

Use Custom Size

Size: 0 0 inches

Rotation Angle: 0°

Auto Selection: Detect Separate Items

Scan To: Pictures

Name: Scan

Format: JPEG

Image Correction: None

Unsharp Mask: None

Descreening: None

Backlight Correction: None

Dust Removal: None

Color Restoration

Hide Details Overview Scan

5. Select the folder in which you want to save your scanned file in the **Scan To** pop-up menu.
6. Click **Scan**.

Your scanned file is saved in the folder you selected.

[Available Scan Settings - OS X Image Capture](#)

**Parent topic:** [Scanning](#)

## Available Scan Settings - OS X Image Capture

You can select these scan settings in your imaging editing application for OS X, if available.

### **Image Correction**

Provides a graphical interface for adjusting brightness, tint, temperature, and saturation.

### **Unsharp Mask**

Makes the edges of certain image areas clearer. Turn off this option to leave softer edges.

### **Descreening**

Removes the ripple pattern that might appear in subtly shaded image areas, such as skin tones. This option improves results when scanning magazines or newspapers. (The results of descreening do not appear in the preview image, only in your scanned image.)

### **Backlight Correction**

Removes shadows from photos that have too much background light.

### **Dust Removal**

Removes dust marks from your originals automatically.

### **Color Restoration**

Restores the colors in faded photos automatically.

**Parent topic:** [Scanning with OS X Using Image Capture](#)

## Scanning Special Projects

Your product's scanning software offers various options to help you quickly complete special scan projects.

[Scanning to a PDF File](#)

[Restoring Photo Colors as You Scan](#)

[Scanning to Online Destinations Using Easy Photo Scan](#)

**Parent topic:** [Scanning](#)

## Scanning to a PDF File

Using Epson Scan in Office, Home, or Professional Mode, you can scan a multi-page document and save it in one PDF (Portable Document Format) file on your computer.

1. Place your original on your product for scanning.
2. Start Epson Scan.
3. Select the scan mode you want to use.
4. Select the scan settings for your scan.
5. Preview your image.
6. When you finish selecting all your settings, click **Scan**.  
You see the File Save Settings window.

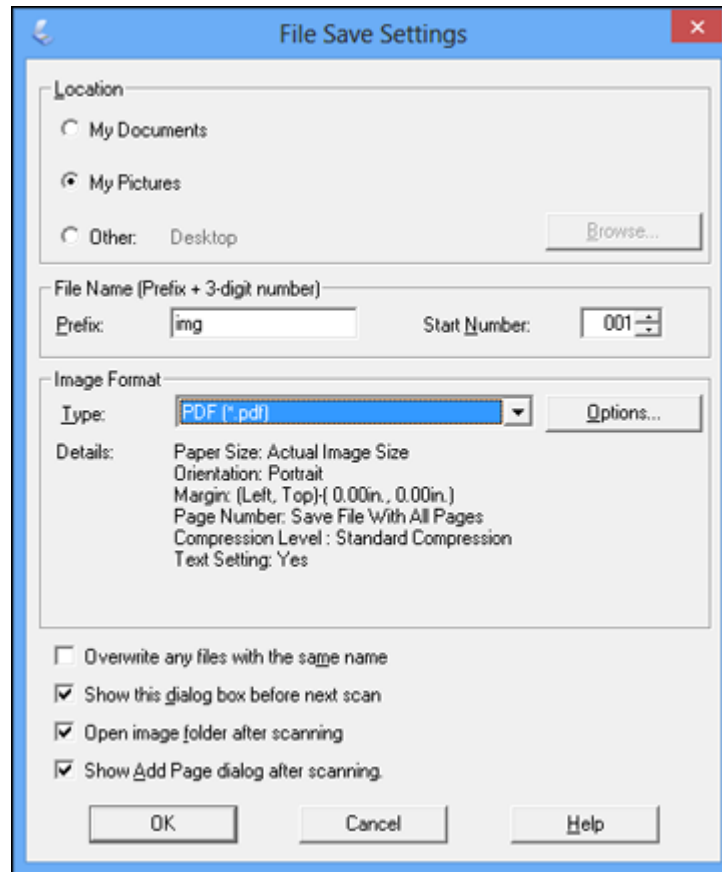

7. Select **PDF** as the Type setting.

8. Select any other settings you want to use on the File Save Settings window. Click the **Options** button to access additional settings.
9. Click **OK**.

Epson Scan scans your document and you see this window:

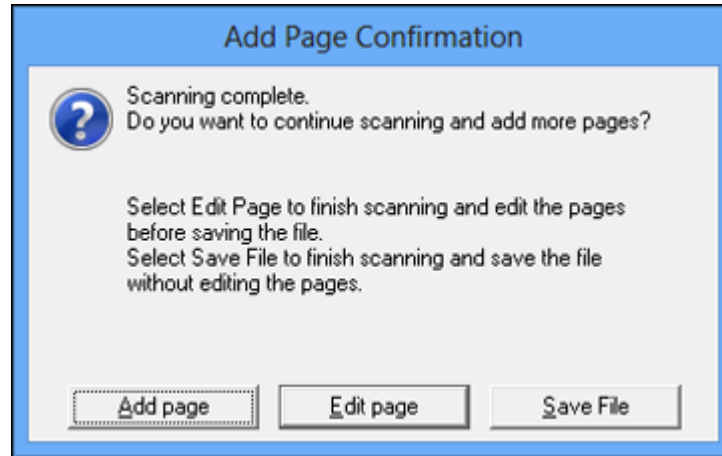

10. Choose one of the following options:
  - If you are scanning only one page, click **Save File**.
  - If you need to scan additional pages in a document, click **Add page**. Place additional pages on the product for scanning, click **Scan**, and repeat until you have scanned all the pages. When you are finished, click **Save File**.
  - If you need to delete or reorder the scanned pages, click **Edit page**. Delete or reorder the pages using the icons that appear on the bottom of the editing window. When you are finished, click **OK**.

**Note:** If you installed an OCR (Optical Character Recognition) program, you may see a screen indicating the program is converting your page to text. Wait until the program re-scans the page and close the program, if necessary.

11. Click **Close** to exit the Epson Scan window, if necessary.

Epson Scan scans your original, and saves the PDF file in the selected folder or opens it in your scanning program. If the file was saved directly to your computer, you see the file in the Windows Explorer or OS X Finder, where you can view and print the document, if desired.

**Parent topic:** [Scanning Special Projects](#)

**Related tasks**

[Starting a Scan Using the Epson Scan Icon](#)

[Selecting the Scan Mode](#)

[Selecting Scan File Settings](#)

## Restoring Photo Colors as You Scan

You can restore the colors in faded photos as you scan them using Epson Scan's Color Restoration setting. You can select this setting in any of the available scan modes.

**Note:** Color restoration is not available in Office Mode, if Epson Scan offers that mode.

1. Place your original on your product for scanning.
2. Start Epson Scan.
3. Select the scan mode you want to use.
4. Select the scan settings for your scan.
5. Preview your image.
6. Locate or access the image adjustment settings.
7. Select the **Color Restoration** checkbox.



8. When you finish selecting all your settings, click **Scan**.
9. Click **Close** to exit the Epson Scan window, if necessary.

Epson Scan scans your original, and saves the color-restored file in the selected folder or opens it in your scanning program. If the file was saved directly to your computer, you see the file in the Windows Explorer or OS X Finder, where you can view and print the image, if desired.

**Parent topic:** [Scanning Special Projects](#)

**Related tasks**

[Placing Originals on the Scanner Glass](#)

[Starting a Scan Using the Epson Scan Icon](#)

[Selecting the Scan Mode](#)  
[Selecting Scan File Settings](#)

## Scanning to Online Destinations Using Easy Photo Scan

You can scan documents or photos and upload them to Facebook and other online destinations, such as photo-sharing sites, web servers, or network folders using Easy Photo Scan.

[Scanning Using Easy Photo Scan](#)

[Uploading Scanned Images to Facebook](#)

[Uploading Scanned Images to Picasa](#)

[Uploading Scanned Images to Evernote](#)

[Uploading Scanned Images to SugarSync](#)

[Uploading Scanned Images to a Web Folder](#)

[Uploading Scanned Images to Email](#)

[Saving Scanned Images to a Folder](#)

[Epson JPEG File Settings](#)

[Epson TIFF and Multi-TIFF File Settings](#)

**Parent topic:** [Scanning Special Projects](#)

## Scanning Using Easy Photo Scan

You can use Easy Photo Scan to easily scan your originals, edit the scanned images, and upload them to Facebook or other online destinations.



**Note:** With OS X, in addition to scanning with Image Capture, you can download and install Epson Scan scanning software. Epson Scan provides additional image adjustment and photo correction features for enhancing scanned images, and provides an interface for TWAIN-compliant OCR scanning software. To download Epson Scan, visit Epson's driver download site ([U.S. downloads](#) or [Canadian downloads](#)).

1. Place your original on your product for scanning.
2. Do one of the following to open Easy Photo Scan:
  - **Windows 8.x:** Navigate to the **Apps** screen and select **Easy Photo Scan**. Select your product and click **OK**, if necessary.
  - **Windows (other versions):** Click  or **Start**, and select **All Programs** or **Programs**. Select **Epson Software** and click **Easy Photo Scan**. Select your product and click **OK**, if necessary.

- **OS X:** Open the **Applications** folder, click **Epson Software**, and click **Easy Photo Scan**. Select your product and click **OK**, if necessary.

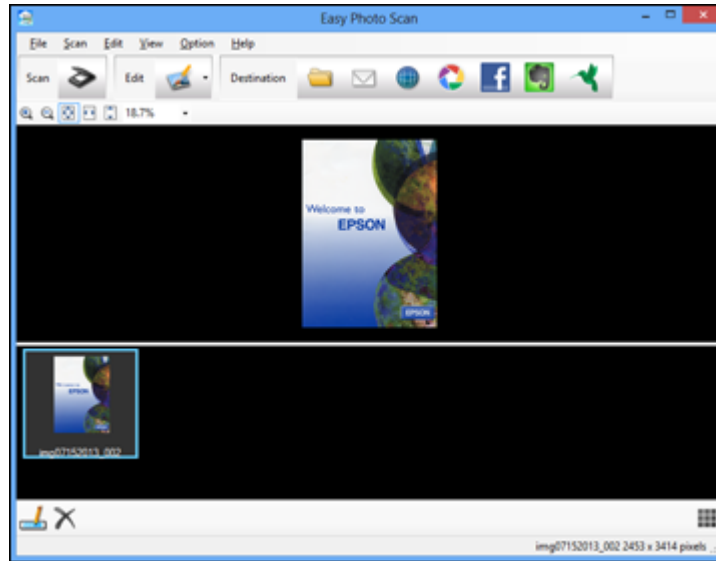
You see a window like this:



3. Click the  Scan icon.  
Your scanning program launches.
4. Click **Scan** in the window that appears to scan your original.  
The scanned image is displayed in the Easy Photo Scan window with an automatically generated name.  
**Note:** You may need to click the **Close** button to display Easy Photo Scan.
5. To edit the name of the file, select the image thumbnail at the bottom of the screen, click the  icon, and enter the new filename.
6. To edit the scanned image, click the  Edit icon and select one of the displayed options.  
**Note:** See the Easy Photo Scan help for additional information on image editing options.

7. Repeat these steps for each image you want to upload.
8. When you finish scanning, click one of the destination icons to upload the images.



**Note:** You may need to click the arrow next to the icons in order to see all of them. The available icons may vary, depending on the software version you are using.

**Parent topic:** [Scanning to Online Destinations Using Easy Photo Scan](#)

**Related tasks**

[Uploading Scanned Images to Facebook](#)

[Uploading Scanned Images to Picasa](#)

[Uploading Scanned Images to Evernote](#)

[Uploading Scanned Images to SugarSync](#)

[Uploading Scanned Images to a Web Folder](#)

[Uploading Scanned Images to Email](#)

[Saving Scanned Images to a Folder](#)

**Uploading Scanned Images to Facebook**

You can configure a Facebook account for use with Easy Photo Scan and upload your scanned images to it.

1. Scan your original using Easy Photo Scan.
2. Click the  icon.

You see a window like this:

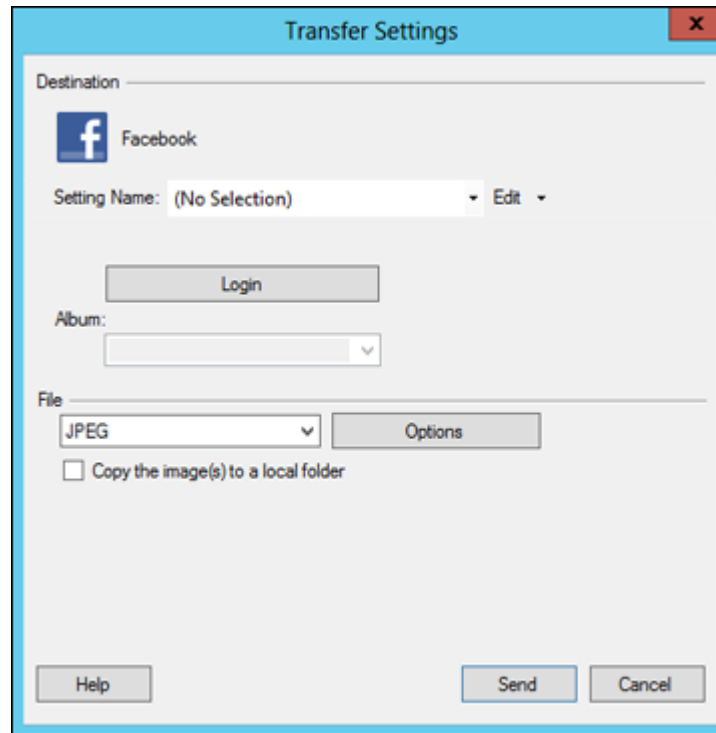

**Note:** If you have already configured a Facebook account in Easy Photo Scan, you can select the **Setting Name** or **Destination Name** for the account, click **Login** if necessary, and click **Send** to upload your images.

3. Click **Login**.
4. On the Application Authentication screen, log in to your Facebook account.

**Note:** To enable automatic image uploading, select the option for staying logged in.

5. Select an album from the **Album** list.

**Note:** If you cannot select an album, make sure the Setting Name is set to **(No Selection)**, click **Login** to log in to your Facebook account, and try again. If you want to create a new album, you must create it directly in Facebook.

6. Select the image format for the uploaded files from the **File** or **File Type** list.
7. If there are options for the selected file format, click **Options** or **Option** and select the options you want.
8. If you also want to save the images to a local folder, select the **Copy the image(s) to a local folder** checkbox and select a folder.
9. If you want to save the current settings, click **Edit**, or the **Setting Name** or **Destination Name** field, and select **Save As**. Enter a name for the setting and click **OK**.
10. Click **Send** to upload the images to your Facebook account, or click **Cancel** to cancel the operation.

**Parent topic:** [Scanning to Online Destinations Using Easy Photo Scan](#)

#### **Related references**

[Epson JPEG File Settings](#)

#### **Related tasks**

[Scanning Using Easy Photo Scan](#)

### **Uploading Scanned Images to Picasa**

You can configure a Picasa account for use with Easy Photo Scan and upload your scanned images.

1. Scan your original using Easy Photo Scan.
2. Click the  icon.

You see a window like this:

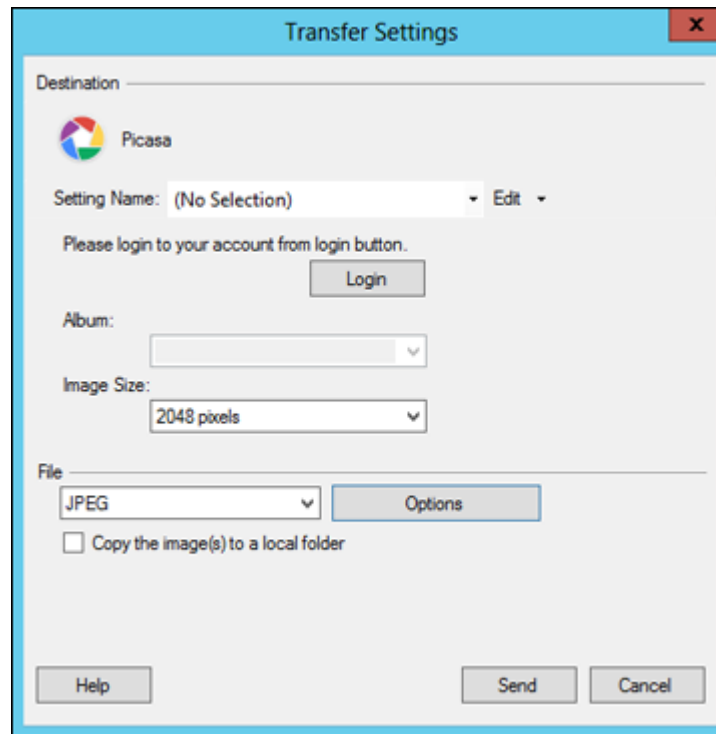

**Note:** If you have already configured a Picasa account in Easy Photo Scan, you can select the **Setting Name** or **Destination Name** for the account, click **Login** if necessary, and click **Send** to upload your images.

3. Click **Login**.
4. On the Application Authentication screen, log into your Google account.
5. Click **Accept** to allow Easy Photo Scan to upload images to your account.  
An authentication code is generated.
6. Copy the authentication code into the **Please enter authentication code** field and click **OK**.

7. Select an album from the **Album** list.

**Note:** If you cannot select an album, make sure the Setting Name is set to **(No Selection)**, click the **Login** button to log into your Picasa account, and try again. If you want to create a new album, you must create it directly in Picasa.

8. Select an **Image Size** option for the uploaded images.
9. Select the image format for the uploaded files from the **File** or **File Type** list.
10. If there are options for the selected file format, click **Options** or **Option** and select the options you want.
11. If you also want to save the images to a local folder, select the **Copy the image(s) to a local folder** checkbox and select a folder.
12. If you want to save the current settings, click **Edit**, or the **Setting Name** or **Destination Name** field, and select **Save As**. Enter a name for the setting and click **OK**.
13. Click **Send** to upload the images to your Picasa account, or click **Cancel** to cancel the operation.

**Parent topic:** [Scanning to Online Destinations Using Easy Photo Scan](#)

**Related references**

[Epson JPEG File Settings](#)

**Related tasks**

[Scanning Using Easy Photo Scan](#)

### Uploading Scanned Images to Evernote

You can configure an Evernote account for use with Easy Photo Scan and upload your scanned images to it (Windows only).

**Note:** You must install Evernote before you can use it with Easy Photo Scan.

1. Scan your original using Easy Photo Scan.
2. Click the  icon.

You see a window like this:

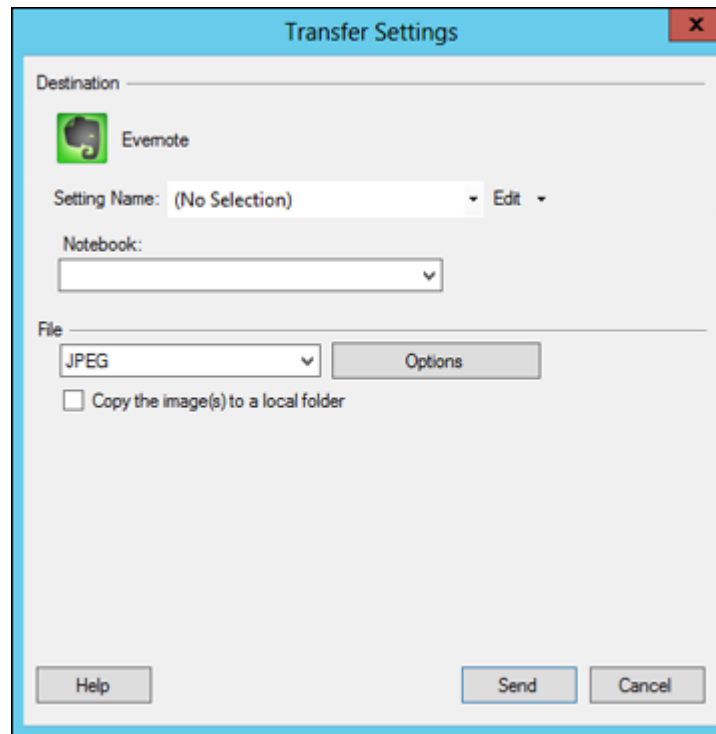

**Note:** If you have already configured an Evernote account in Easy Photo Scan, you can select the **Setting Name** or **Destination Name** for the account and click **Send** to upload your images.

3. Select a notebook from the **Notebook** list.

**Note:** If you want to create a new notebook, you must create it directly in Evernote.

4. Select the image format for the uploaded files from the **File** or **File Type** list.
5. If there are options for the selected file format, click **Options** or **Option** and select the options you want.
6. If you also want to save the images to a local folder, select the **Copy the image(s) to a local folder** checkbox and select a folder.

7. If you want to save the current settings, click **Edit**, or the **Setting Name** or **Destination Name** field, and select **Save As**. Enter a name for the setting and click **OK**.
8. Click **Send** to upload the images to your Evernote account, or click **Cancel** to cancel the operation.

**Parent topic:** [Scanning to Online Destinations Using Easy Photo Scan](#)

**Related references**

[Epson JPEG File Settings](#)

**Related tasks**

[Scanning Using Easy Photo Scan](#)

### **Uploading Scanned Images to SugarSync**

You can configure a SugarSync account for use with Easy Photo Scan and upload your scanned images.

1. Scan your original using Easy Photo Scan.
2. Click the  icon.

You see a window like this:

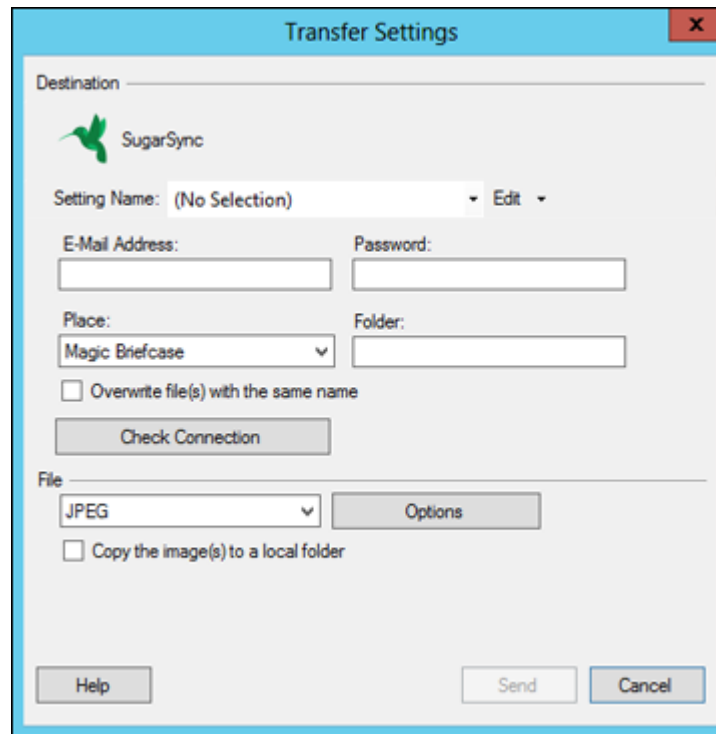

The screenshot shows a 'Transfer Settings' dialog box with a blue title bar and a red close button. The window is divided into two main sections: 'Destination' and 'File'.  
In the 'Destination' section, there is a SugarSync logo, a 'Setting Name' dropdown menu currently set to '(No Selection)', and an 'Edit' button. Below this are two text input fields for 'E-Mail Address' and 'Password'. Further down are two more dropdown menus: 'Place' (set to 'Magic Briefcase') and 'Folder'. A checkbox labeled 'Overwrite file(s) with the same name' is currently unchecked. A 'Check Connection' button is located below these options.  
The 'File' section contains a dropdown menu for file format, currently set to 'JPEG', and an 'Options' button. Below this is another checkbox labeled 'Copy the image(s) to a local folder', which is also unchecked.  
At the bottom of the dialog, there are three buttons: 'Help', 'Send', and 'Cancel'.

**Note:** If you have already configured a SugarSync account in Easy Photo Scan, you can select the **Setting Name** or **Destination Name** for the account and click **Send** to upload your images.

3. Enter the account information in the **E-Mail Address** and **Password** fields.
4. Select a **Place** option for the uploaded images.

**Note:** In SugarSync, the Magic Briefcase is now called "My SugarSync". Uploads to the Magic Briefcase appear in the My SugarSync folder.

5. Enter a folder name in the **Folder** field.

If you enter the name of an existing folder, the images are uploaded to that folder. If the folder does not exist, a new folder with that name is created.

6. If you want to replace existing files with the same name with the uploaded images, click the **Overwrite file(s) with the same name** checkbox.
7. Click **Check Connection** to test whether the SugarSync account information is correct.
8. Select the image format for the uploaded files from the **File** or **File Type** list.
9. If there are options for the selected file format, click **Options** or **Option** and select the options you want.
10. If you also want to save the images to a local folder, select the **Copy the image(s) to a local folder** checkbox and select a folder.
11. If you want to save the current settings, click **Edit**, or the **Setting Name** or **Destination Name** field, and select **Save As**. Enter a name for the setting and click **OK**.
12. Click **Send** to upload the images to your SugarSync account, or click **Cancel** to cancel the operation.

**Parent topic:** [Scanning to Online Destinations Using Easy Photo Scan](#)

**Related references**

[Epson JPEG File Settings](#)

[Epson TIFF and Multi-TIFF File Settings](#)

**Related tasks**

[Scanning Using Easy Photo Scan](#)

### Uploading Scanned Images to a Web Folder

You can upload your scanned images to a Web Folder (WebDAV) using Easy Photo Scan.

1. Scan your original using Easy Photo Scan.
2. Click the  icon.

You see a window like this:

The screenshot shows a 'Transfer Settings' dialog box. The title bar is blue with the text 'Transfer Settings' and a close button. The main area is light gray. At the top, there's a 'Destination' section with a globe icon and the text 'Web Folder (WebDAV)'. Below that is a 'Setting Name' dropdown menu showing '(No Selection)' and an 'Edit' button. The 'Address' field contains 'http://www.example.com/upload'. There are 'User Name' and 'Password' fields. An 'Overwrite file(s) with the same name' checkbox is present. A 'Check Connection' button is below. The 'File' section has a dropdown menu showing 'JPEG' and an 'Options' button. A 'Copy the image(s) to a local folder' checkbox is at the bottom. At the very bottom are 'Help', 'Send', and 'Cancel' buttons.

**Note:** If you have already configured a Web Folder account in Easy Photo Scan, you can select the **Setting Name** or **Destination Name** for the account and click **Send** to upload your pictures.

3. Enter the Web Folder URL in the **Address** field.
4. Enter the login information in the **User Name** and **Password** fields.
5. If you want to replace existing files with the same name with the uploaded images, click the **Overwrite file(s) with the same name** checkbox.
6. Click **Check Connection** to test whether the account information is correct.
7. Select the image format for the uploaded files from the **File** or **File Type** list.
8. If there are options for the selected file format, click **Options** or **Option** and select the options you want.

9. If you also want to save the images to a local folder, select the **Copy the image(s) to a local folder** checkbox and select a folder.
10. If you want to save the current settings, click **Edit**, or the **Setting Name** or **Destination Name** field, and select **Save As**. Enter a name for the setting and click **OK**.
11. Click **Send** to upload the images to your Web Folder, or click **Cancel** to cancel the operation.

**Parent topic:** [Scanning to Online Destinations Using Easy Photo Scan](#)

#### **Related references**

[Epson JPEG File Settings](#)

[Epson TIFF and Multi-TIFF File Settings](#)

#### **Related tasks**

[Scanning Using Easy Photo Scan](#)

### **Uploading Scanned Images to Email**

You can save your scanned images to a local network folder and send them by email using Easy Photo Scan.

**Note:** With Windows, Easy Photo Scan supports Microsoft Outlook 2000/2002/2003/2007/2010 (x86)/2013 (x86) and Windows Mail/Windows Live Mail. If you do not have one of these email applications, Easy Photo Scan saves the images, but the email application does not open.

1. Scan your original using Easy Photo Scan.
2. Click the  icon.

You see a window like this:

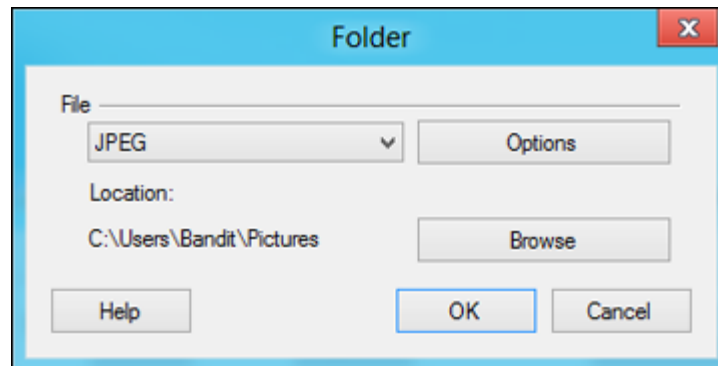

**Note:** With OS X, you also enter an email address and email text in the window. If you have already configured email settings in Easy Photo Scan, you can select them using the **Destination Name** field.

3. Select the image format for the saved files from the **File** or **File Type** list.
4. If there are options for the selected file format, click **Options** or **Option** and select the options you want.
5. Do one of the following:
  - **Windows:** Click **Browse** to choose the folder where you want to save the images. Then click **OK** to save the images to the folder and launch your email program, or click **Cancel** to cancel the operation.
  - **OS X:** If you also want to save the images to a local folder, select the **Copy the image(s) to a local folder** checkbox and select a folder. Then click **Send**, or click **Cancel** to cancel the operation.

**Parent topic:** [Scanning to Online Destinations Using Easy Photo Scan](#)

#### **Related references**

[Epson JPEG File Settings](#)

[Epson TIFF and Multi-TIFF File Settings](#)

#### **Related tasks**

[Scanning Using Easy Photo Scan](#)

### **Saving Scanned Images to a Folder**

You can save your scanned images to a local network folder using Easy Photo Scan.

1. Scan your original using Easy Photo Scan.
2. Click the  icon.

You see a window like this:

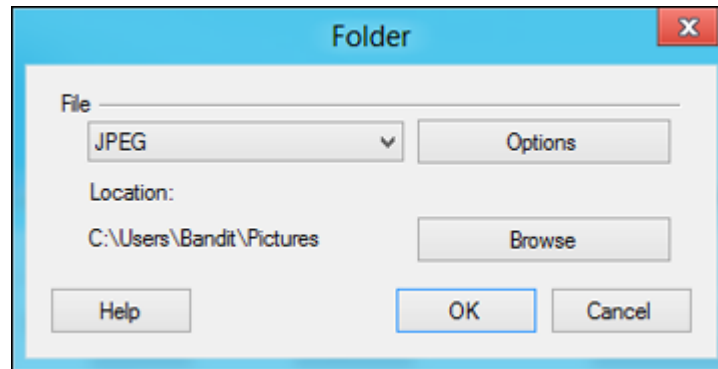

3. Select the image format for the saved files from the **File** or **File Type** list.
4. If there are options for the selected file format, click **Options** and select the options you want.
5. Click **Browse** or the **Save in** field to choose the folder where you want to save the images.
6. Click **OK** to save the images to the folder, or click **Cancel** to cancel the operation.

**Parent topic:** [Scanning to Online Destinations Using Easy Photo Scan](#)

#### **Related references**

[Epson JPEG File Settings](#)

[Epson TIFF and Multi-TIFF File Settings](#)

#### **Related tasks**

[Scanning Using Easy Photo Scan](#)

### **Epson JPEG File Settings**

You can select from the following settings in the JPEG settings window in Easy Photo Scan.

**Note:** The available settings may vary, depending on the operating system you are using.

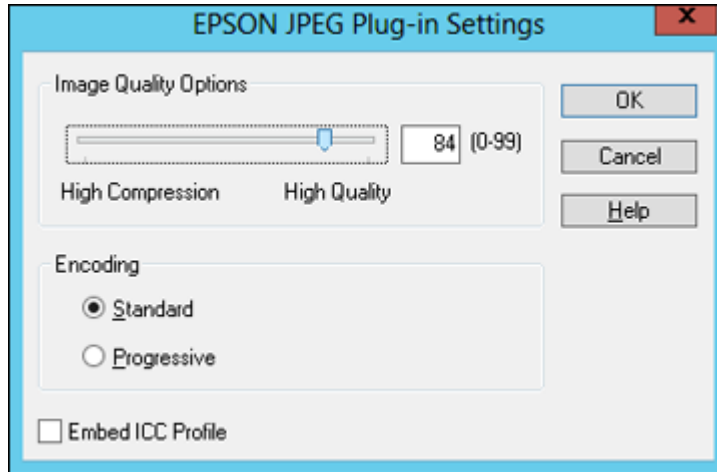

Setting	Description
<b>Image Quality Options</b>	Specifies the compression level. The file size increases with higher quality.
<b>Encoding</b>	Specifies the encoding method. <b>Standard:</b> Images are rendered from the top to the bottom when displayed on a web browser. <b>Progressive:</b> Images are rendered in low resolution in a web browser, then replaced with a higher resolution.
<b>Embed ICC Profile</b>	Allows the ICC profile (information on color reproducibility of scanned image) to be embedded in the image. Programs that use color management software will display the colors of the image using the ICC profile.

Parent topic: [Scanning to Online Destinations Using Easy Photo Scan](#)

### Epson TIFF and Multi-TIFF File Settings

You can select from the following settings in the TIFF settings window in Easy Photo Scan.

**Note:** The available settings may vary, depending on the operating system you are using.

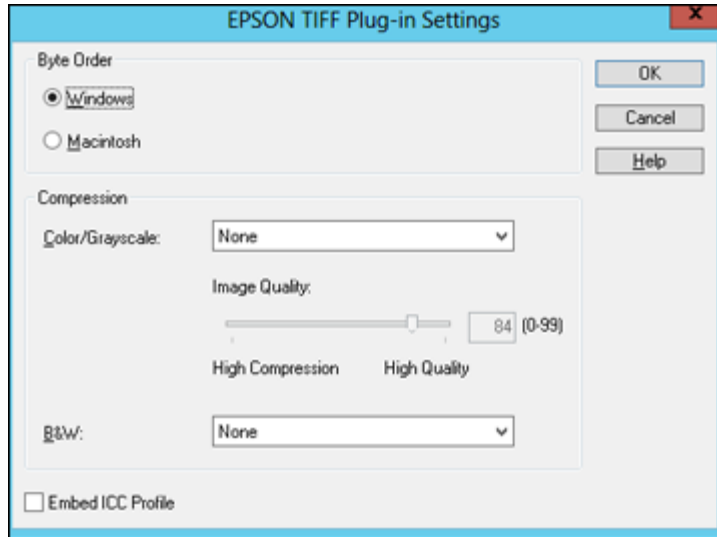

Setting	Description
<b>Byte Order</b>	Specifies the operating system where the scanned image will be used.
<b>Compression</b>	Specifies the compression format and level for Color/Grayscale and B&W images. The file size increases with higher quality.
<b>Embed ICC Profile</b>	Allows the ICC profile (information on color reproducibility of scanned image) to be embedded in the image. Programs that use color management software will display the colors of the image using the ICC profile.

**Parent topic:** [Scanning to Online Destinations Using Easy Photo Scan](#)

---

# Using Memory Cards With Your Product

Follow the instructions here to work with a memory card inserted into your product.

[Inserting a Memory Card](#)

[Printing from a Memory Card](#)

[Transferring Photos on a Memory Card](#)

## Inserting a Memory Card

Insert only one memory card at a time into a memory card slot on your product.

1. Make sure the memory card and the files on it are compatible with your product before inserting the card.
2. Open the cover and insert your memory card into the correct slot, making sure the card is oriented correctly.

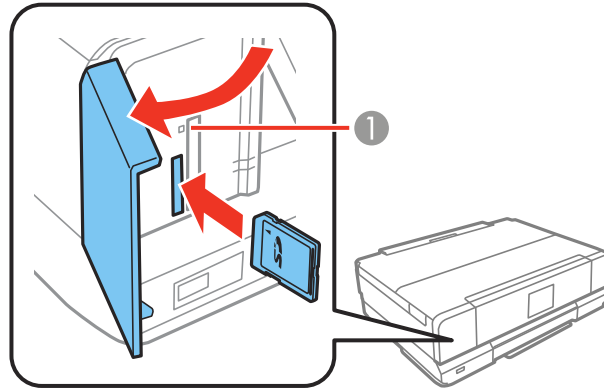

1 Memory card access light

**Note:** Do not force the card all the way into the slot. Insert it only until it meets resistance.

The memory card access light flashes and then stays lit.

**Caution:** Do not remove a memory card or turn off your product while the memory card access light is flashing or you may lose data from the memory card.

[Memory Card Types](#)

[Memory Card File Specifications](#)

[Removing a Memory Card](#)

**Parent topic:** [Using Memory Cards With Your Product](#)

## Memory Card Types

You can insert these types of memory cards in your product.

**Note:** Cards marked with an asterisk (\*) require an adapter; consult your adapter documentation for details on using it.

### Left Slot

You can insert the following cards in the left slot:

- Memory Stick Duo
- Memory Stick PRO Duo
- Memory Stick PRO-HG Duo
- Memory Stick Micro\*
- MagicGate Memory Stick Duo
- SDXC
- SDHC
- SD
- miniSDHC\*
- miniSD\*
- microSDXC\*
- microSDHC\*
- microSD\*

### Right Slot

You can insert the following cards in the right slot:

- CompactFlash
- Microdrive

Parent topic: [Inserting a Memory Card](#)

## Memory Card File Specifications

You can insert memory cards in your product containing files that meet these specifications.

<b>File format</b>	JPEG with the Exif version 2.3 standard
<b>Image size</b>	80 × 80 pixels to 10200 × 10200 pixels
<b>Number of files</b>	Up to 9990

Parent topic: [Inserting a Memory Card](#)

## Removing a Memory Card

After you finish working with a memory card, check to make sure it is safe to remove it from your product.

**Caution:** Do not remove a memory card or turn off your product while the memory card access light is flashing or you may lose data from the memory card.

1. Make sure the memory card access light is not flashing.

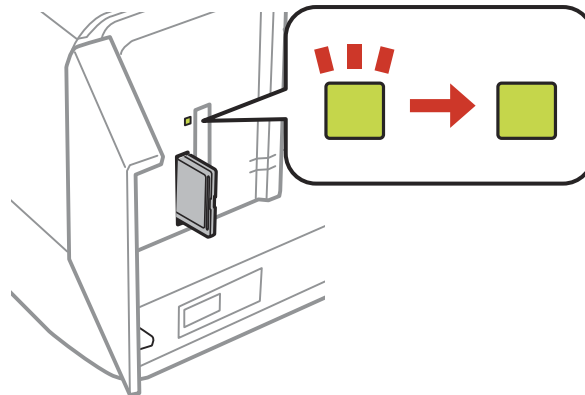

2. If your product is connected to your computer using a USB cable, do one of the following:
  - **Windows:** Open the **My Computer**, **Computer**, **Windows Explorer**, or **File Explorer** utility. Then right-click the name of your memory card (listed as a removable disk) and select **Eject**.
  - **OS X:** Drag the removable disk icon for your memory card from the desktop or computer window into the trash.
3. Pull the memory card straight out of its slot.

**Parent topic:** [Inserting a Memory Card](#)

## Printing from a Memory Card

See these sections to print photos from a memory card inserted into your product:

[Viewing and Printing Photos](#)

[Printing Photo Layouts from a Memory Card](#)

[Printing Photo Greeting Cards](#)

**Parent topic:** [Using Memory Cards With Your Product](#)

## Viewing and Printing Photos

See these sections to view and print photos displayed on your product's LCD screen.

[Viewing and Printing Photos From the LCD Screen](#)

[Cropping Photos Displayed on the LCD Screen](#)

[Photo Adjustment Options - Memory Card](#)

[Print Setting Options - Memory Card](#)

[Paper Type Settings - Memory Card](#)

**Parent topic:** [Printing from a Memory Card](#)

## Viewing and Printing Photos From the LCD Screen

You can select photos for printing as you view them on the LCD screen.

1. Select **Print Photos**.



2. Do one of the following to select your photos:
  - To select individual photos, select the thumbnail image of the photo you want to print and press the **+** button or the **-** button to select the number of copies (up to 99). Press the left or right arrow button to scroll through and select additional photos, or press the ↶ **Back** button to return to the thumbnail image view and select another photo.
  - To select all photos, select **Options > Select Photos > Select All Photos**, then press the **+** button or the **-** button to select the number of copies (up to 99). Select **Done** when finished.
  - To select photos based on the date they were taken, select **Options > Browse > Browse by Date** and select any of the dates shown. Select **Proceed** and select the photos you want to print.
3. To adjust your photos, do either of the following as necessary (adjustments modify only your printed copy, not the original file):
  - To crop, zoom into, or rotate a photo, select the thumbnail image of the photo you want to modify, select **Edit > Crop/Zoom**. Make the necessary adjustments, select **OK** and select **OK** again.
  - To change the appearance (such as brightness and contrast) of your printed photos, select the thumbnail image of a photo, select **Edit > Photo Adjustments**, and select the necessary settings. When you are finished, press the ↶ **Back** button twice.
4. To change the print settings, select **Settings** and select the necessary settings. When you are finished, press the ↶ **Back** button.
5. When you are ready to print, press the ⬠ **Start** button.

**Note:** To cancel printing, select **Cancel**.

**Parent topic:** [Viewing and Printing Photos](#)

**Related references**

[Photo Adjustment Options - Memory Card](#)

[Print Setting Options - Memory Card](#)

**Related tasks**

[Cropping Photos Displayed on the LCD Screen](#)

**Cropping Photos Displayed on the LCD Screen**

If you want to crop or rotate photos displayed on the LCD screen, select the thumbnail image of the photo you want to modify, select **Edit > Crop/Zoom**, and select the necessary options.

- To crop the photo, press the + button to move the yellow crop area inward or the – button to move the crop area outward.
- To move the crop area, use the arrow buttons.
- To rotate the crop area, select .
- To check the cropped image, select **OK**.

**Parent topic:** [Viewing and Printing Photos](#)

**Photo Adjustment Options - Memory Card**

Select the **Photo Adjustment** options you want to use when viewing and printing photos displayed on the LCD screen. The modifications affect only the printed copy of the photo, not the original file.

Photo Adjustment settings	Available options	Description
<b>Fix Photo</b>	<b>Fix Photo Off</b>	Turns off automatic adjustments; see <b>Note</b> below
	<b>Automatic</b>	Optimizes the <b>Fix Photo</b> adjustments for specific types of photos; select the option that best matches your photo content
	<b>People</b>	
	<b>Landscape</b>	
	<b>Night Scene</b>	
<b>P.I.M.</b>	Uses your camera's PRINT Image Matching or Exif Print adjustments	

Photo Adjustment settings	Available options	Description
<b>Fix Red-Eye</b>	<b>Off - Current</b>	Automatically fixes the red-eye effect in photos
	<b>On - Current</b>	
	<b>Off - All Photos</b>	
	<b>On - All Photos</b>	
<b>Brightness</b>	Various settings	Adjust individual qualities in your photo
<b>Contrast</b>		
<b>Sharpness</b>		
<b>Saturation</b>		

**Note: Fix Photo** uses a sophisticated face recognition technology to optimize photos that include faces. For this to work, both eyes and the nose must be visible in the subject's face. If your photo includes a face with an intentional color cast, such as a statue, you may want to turn off **Fix Photo** to retain the special color effects.

Parent topic: [Viewing and Printing Photos](#)

### Print Setting Options - Memory Card

Select the **Print Settings** options you want to use when printing photos displayed on the LCD screen.

Print settings	Available options	Description
<b>Paper Size</b>	Various paper sizes	Indicates the size of paper you have loaded
<b>Paper Type</b>	Various paper types	Indicates the type of paper you have loaded; see the list of paper types for memory card (available options depend on the selected <b>Paper Size</b> setting)

<b>Print settings</b>	<b>Available options</b>	<b>Description</b>
<b>Paper Source</b>	<b>Cassette 1</b>	Prints onto paper loaded in Cassette 1 (upper cassette)
	<b>Cassette 2</b>	Prints onto paper loaded in Cassette 2 (lower cassette)
	<b>Cassette 1&gt;Cassette 2</b>	Prints onto paper loaded in Cassette 1 and then onto paper loaded in Cassette 2 when the first cassette is empty (load the same size and type of paper in both cassettes when selecting this option)
	<b>Rear Paper Feed Slot</b>	Prints onto paper loaded in the rear paper feed slot
<b>Borderless</b>	<b>Borderless</b>	Expands the image to the edge of the paper (slight cropping may occur)
	<b>With Border</b>	Leaves a small margin around the image
<b>Quality</b>	<b>Draft</b>	Provides lower quality for draft printing
	<b>Standard</b>	Provides good quality for most prints
	<b>Best</b>	Provides the highest quality for important prints
<b>Expansion</b>	<b>Standard</b>	Expands images correctly for most borderless prints
	<b>Medium</b>	Expands images slightly less for borderless prints
	<b>Minimum</b>	Expands images the least for borderless prints (you may see some white border)
<b>Date</b>	Various date formats	Prints the date the photo was taken on the photo in the format you select
<b>Print Info. On Photos</b>	<b>Camera Settings</b>	Prints settings that you added in your camera
	<b>Camera Text</b>	Prints text that you added in your camera
	<b>Landmark</b>	Prints location information embedded in a photo by cameras that have a built-in GPS feature
	<b>Off</b>	Turns off printing info from your camera
<b>Fit Frame</b>	<b>On</b>	Automatically crops the photo to fit into the selected photo layout
	<b>Off</b>	Turns off automatic cropping

Print settings	Available options	Description
<b>Bidirectional</b>	<b>On</b>	Prints at normal speed
	<b>Off</b>	Slows down printing to improve print quality
<b>Clear All Settings</b>	<b>Yes</b>	Clears all print settings
	<b>No</b>	

**Parent topic:** [Viewing and Printing Photos](#)

**Related references**

[Paper Type Settings - Memory Card](#)

### **Paper Type Settings - Memory Card**

Select a **Paper Type** setting that matches the paper you loaded.

Paper type loaded	Paper Type setting
Plain paper Epson Bright White Paper Epson Presentation Paper Matte Epson Iron-on Cool Peel Transfer paper Epson Photo Quality Self-adhesive Sheets	Plain Paper
Epson Premium Presentation Paper Matte	Prem. Matte
Epson Premium Presentation Paper Matte Double-sided Epson Ultra Premium Presentation Paper Matte	Presentation Matte
Epson Premium Photo Paper Glossy Epson Ultra Premium Photo Paper Luster	Prem. Glossy
Epson Premium Photo Paper Semi-gloss	Prem. Semi-Gloss
Epson Ultra Premium Photo Paper Glossy	Ultra Glossy
Epson Photo Paper Glossy	Glossy
Epson Velvet Fine Art Paper	Velvet Fine Art Paper

**Parent topic:** [Viewing and Printing Photos](#)

## Printing Photo Layouts from a Memory Card

You can print one or more photos from a memory card in special layouts on various sizes of photo paper.

1. Press the  home button, if necessary.
2. Select **More Functions**.



3. Select **Photo Layout Sheet**.

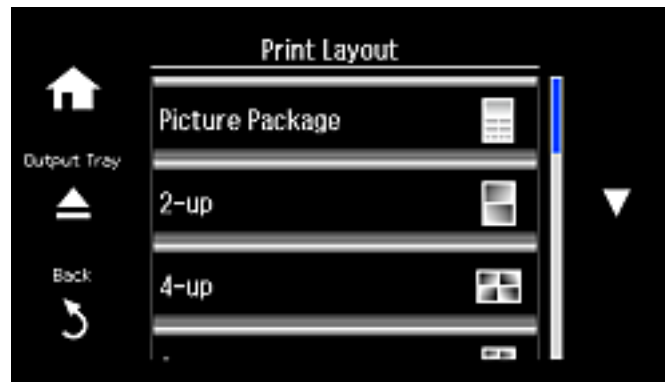

4. Scroll down to view all of the layout options, then select the option you want.
5. Select the paper size and paper type that matches the paper you loaded and select **Proceed**.

6. If you see a screen asking you to choose between automatic and manual placement of photos, do one of the following:
  - Select **Automatic layout** if you want to allow your product to place the photos in the layout automatically.
  - Select **Place photos manually** to place photos in the layout manually.
7. Select the photos you want to print and select **Proceed**. If you chose to place the photos manually, follow the instructions on the LCD screen to select and place your photos on the layout, then select **Proceed**.
8. Press the **+** or **-** button to select the number of layout sheets to print (up to 99) and select **Proceed**.
9. Select additional print settings for your layout as necessary.
10. When you are ready to print, press the **Start** button.

**Note:** To cancel printing, select **Cancel**.

### [Photo Layout Options](#)

**Parent topic:** [Printing from a Memory Card](#)

#### **Photo Layout Options**

Select the layout you want to use when printing your photos in a layout.

##### **Picture Package**

Prints one photo in multiple sizes on one sheet.

##### **2-up, 4-up, 8-up, or 20-up**

Print 2, 4, 8, or 20 photos on one sheet.

##### **Upper ½ or Lower ½**

Print one photo in the upper or lower half of the sheet.

##### **Photo ID**

Prints 4 ID-sized photos on one sheet.

##### **Jewel Upper**

Prints one photo on the upper half of a folded jewel case insert.

##### **Jewel Index**

Prints 24 to 48 thumbnail images on a folded jewel case insert.

**Parent topic:** [Printing Photo Layouts from a Memory Card](#)

## Printing Photo Greeting Cards

You can create custom greeting cards using photos on your memory card or other device, and add your own handwritten or printed text.

First you select your photo and print a template on plain paper. Then you fill out the template, add your message, and print your cards.

[Creating and Printing a Greeting Card Template](#)

[Printing a Greeting Card from a Template](#)

**Parent topic:** [Printing from a Memory Card](#)

### Creating and Printing a Greeting Card Template

Before you start, make sure plain paper is loaded and your memory card is inserted.

1. Press the  home button, if necessary.
2. Select **More Functions**.



3. Select **Greeting Card**.



4. Select **Select Photo and Print Template**.
5. Select the photo you want and select **Proceed**.
6. Select **Paper Size** and select **Letter** to print three cards on one letter-size sheet or **4x6in** to print one card.
7. Select **Paper Type** and select the type of paper you plan to use.
8. Select the other print settings as necessary and select **Proceed**.
9. When you are ready to print your greeting card template on plain paper, press the **Start** button.

**Parent topic:** [Printing Photo Greeting Cards](#)

**Related tasks**

[Inserting a Memory Card](#)

**Related topics**

[Loading Paper](#)

**Printing a Greeting Card from a Template**

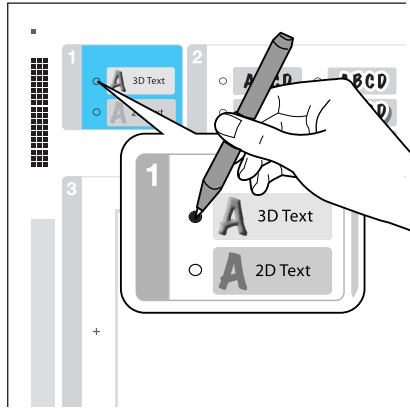

After your greeting card template is printed, you fill it out to create your card and add your message.

1. Use a dark pen or pencil to fill in the circles and select the Text Style and Text Effects.



2. Add your greeting card message within the box. You can write it in by hand, print a message and paste it into the box, or draw a picture.

**Tip:** When adding text, place it in the direction that your photo faces.

3. Load photo paper either in Cassette 2 (lower) for this size: Letter (8.5 × 11 inches [216 × 279 mm]), or in Cassette 1 (upper) for this size: 4 × 6 inches (102 × 152 mm).
4. Select **Print Greeting Cards from Template**. (If you do not see this option, press the  home button and select **More Functions > Greeting Card > Print Greeting Cards from Template**.)
5. Follow the instructions on the LCD screen to place the template facedown on the scanner glass, with the blue triangle facing into the front right corner.
6. Close the document cover and select **Proceed**.
7. To print more than one copy, press the **+** or **-** button to select the number (up to 99).
8. When you are ready to print, press the  **Start** button.

**Note:** To cancel printing, select **Cancel**.

When you finish printing, cut your greeting cards apart, if necessary.

**Parent topic:** [Printing Photo Greeting Cards](#)

### Related tasks

[Creating and Printing a Greeting Card Template](#)

## Transferring Photos on a Memory Card

You can transfer photos to and from a memory card inserted into a memory card slot on your product.

[Setting Up File Sharing for Photo Transfers From Your Computer](#)

[Transferring Photos from a Memory Card to Your Computer](#)

**Parent topic:** [Using Memory Cards With Your Product](#)

## Setting Up File Sharing for Photo Transfers From Your Computer

Before you transfer photos from a computer to a memory card inserted into a memory card slot on your product, you may need to set up your product's file sharing settings.

1. Remove any memory cards from the product.

**Caution:** Remove the memory card before you change the file sharing settings or you may lose data from the memory card. Do not remove a memory card or turn off your product while the memory card access light is flashing or you may lose data from the memory card.

2. Press the  home button, if necessary.
3. Select **Setup**.
4. Scroll down and select **File Sharing Setup**.
5. Select the connection type between the printer and your computer.

**Parent topic:** [Transferring Photos on a Memory Card](#)

### Related tasks

[Removing a Memory Card](#)

## Transferring Photos from a Memory Card to Your Computer

You can transfer photos to and from a memory card inserted into a memory card slot on your product and a computer connected to your product.

**Note:** Do not transfer photos to and from a memory card while you are printing from the memory card.

1. Make sure your product is connected to a computer.

2. Insert a memory card into a memory card slot on your product.
3. Do one of the following to access your memory card files from your computer:
  - **Windows:** Open the **Computer**, **My Computer**, **Windows Explorer**, or **File Explorer** utility, then select the removable disk icon.
  - **OS X with a USB connection:** Look for the removable disk icon on your desktop or computer window, then select it.
  - **OS X with a network connection:** Select the hard drive icon on your desktop or computer window, select your product in the **SHARED** section of the sidebar (you may need to widen the sidebar to see the name), then select the **MEMORYCARD** icon.
4. Select the folder that contains your photos.
5. Drag the photos you want to transfer to the desired folder on your computer or on your memory card.

**Note:** Your product's LCD screen does not update to display new photos transferred to the memory card. Wait until the memory card access light stops flashing, then remove and insert the memory card to update the photos displayed.

**Parent topic:** [Transferring Photos on a Memory Card](#)

**Related tasks**

[Inserting a Memory Card](#)

[Removing a Memory Card](#)

---

# Using an External Device with Your Product

Follow the instructions in these sections to use your product with an external device, such as a camera, smartphone, or other device.

[Printing from a Camera](#)

[Viewing or Printing from a USB Flash Drive or External Device](#)

## Printing from a Camera

If you have a digital camera that supports PictBridge printing, you can print your photos directly from the camera. Check your camera manual to see if it is compatible.

**Note:** Your photos must be in JPG format and sized from 80 × 80 to 10200 × 10200 pixels. Epson cannot guarantee the compatibility of your camera. Some combinations of paper type, size, and layout may not be supported, depending on your camera and the product settings.

[Selecting Print and Photo Adjustment Settings](#)

[Connecting and Printing from a Camera](#)

[Printing from a Camera Wirelessly](#)

**Parent topic:** [Using an External Device with Your Product](#)

## Selecting Print and Photo Adjustment Settings

Before printing from your camera, you can make image adjustments and select the print settings for your photos. Image adjustments affect only the printed copy of the photo, not the original file.

1. Press the  home button, if necessary.

2. Press the left or right arrow button and then select **Setup**.



3. Scroll down and select **External Device Setup**.

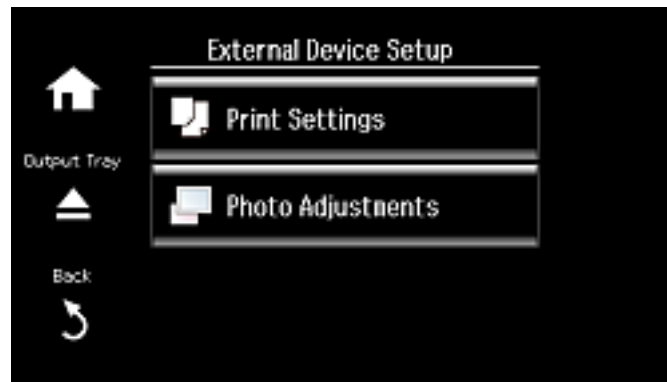

4. Select **Print Settings**.

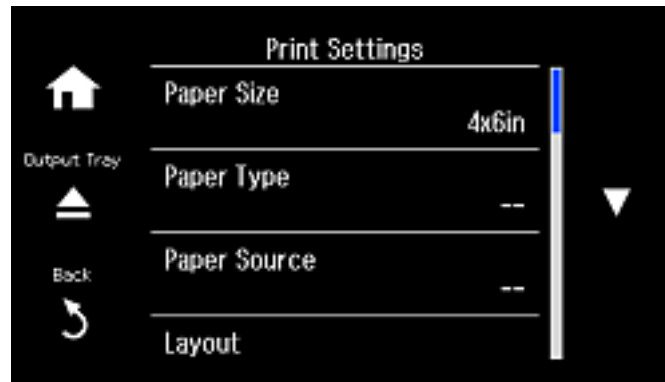

5. Select the print settings you want to use.
6. When you are done, press the ↶ **Back** button.
7. Select **Photo Adjustments**.

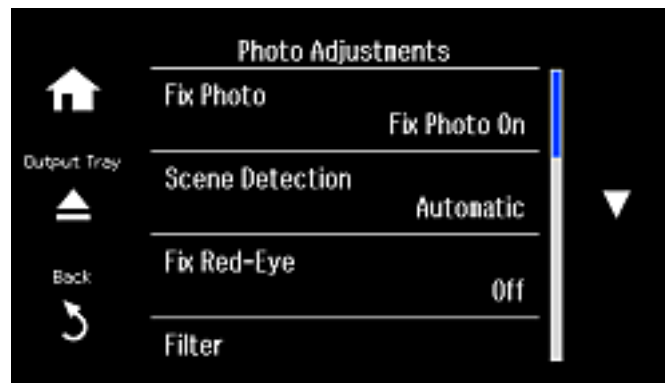

8. Select the photo adjustments you want to use. Press the 🏠 home button to exit.  
After you select settings, you are ready to connect your camera and print your photos.

[Print Settings - Camera](#)

[Photo Adjustments - Camera](#)

Parent topic: [Printing from a Camera](#)

**Print Settings - Camera**

Select the **Print Settings** options you want to use when printing photos from your camera.

<b>Print settings</b>	<b>Available options</b>	<b>Description</b>
<b>Paper Size</b>	Various paper sizes	Indicates the size of paper you have loaded
<b>Paper Type</b>	Various paper types	Indicates the type of paper you have loaded; see the list of paper types for copying (available options depend on the selected <b>Paper Size</b> setting)
<b>Paper Source</b>	<b>Cassette 1</b>	Prints onto paper loaded in Cassette 1 (upper cassette)
	<b>Cassette 2</b>	Prints onto paper loaded in Cassette 2 (lower cassette)
	<b>Cassette 1&gt; Cassette 2</b>	Prints onto paper loaded in Cassette 1 and then onto paper loaded in Cassette 2 when the first cassette is empty (load the same size and type of paper in both cassettes when selecting this option)
	<b>Rear Paper Feed Slot</b>	Prints onto paper loaded in the rear paper feed slot

<b>Print settings</b>	<b>Available options</b>	<b>Description</b>
<b>Layout</b>	<b>Borderless</b>	Expands the image to the edge of the paper (slight cropping may occur)
	<b>With Border</b>	Leaves a small margin around the image
	<b>Picture Package</b>	Prints one photo in multiple sizes on one sheet
	<b>2-up, 4-up, 8-up, 20-up, 30-up, or 80-up</b>	Prints the selected number of photos on one sheet or CD/DVD
	<b>Photo ID</b>	Prints 4 ID-sized photos on one sheet
	<b>Upper ½ or Lower ½</b>	Print one photo in the upper or lower half of the sheet
	<b>Jewel Upper</b>	Prints one photo on the upper half of a folded jewel case insert
	<b>Jewel Index</b>	Prints 24 to 48 thumbnail images on a folded jewel case insert
<b>Quality</b>	<b>Draft</b>	Provides lower quality for draft printing
	<b>Standard</b>	Provides good quality for most prints
	<b>Best</b>	Provides the highest quality for important prints
<b>Expansion</b>	<b>Standard</b>	Expands images correctly for most borderless prints
	<b>Medium</b>	Expands images slightly less for borderless prints
	<b>Minimum</b>	Expands images the least for borderless prints (you may see some white border)
<b>Date</b>	<b>Off</b>	Does not print the date on which the photo was taken
	<b>On</b>	Prints the date on which the photo was taken

Print settings	Available options	Description
<b>Print Info. On Photos</b>	<b>Off</b>	Turns off printing info from your camera
	<b>Camera Settings</b>	Prints your camera's shutter speed, aperture, and ISO speed
	<b>Camera Text</b>	Prints text that you added in your camera
	<b>Landmark</b>	Prints location information embedded in a photo by cameras that have a built-in GPS feature
<b>Fit Frame</b>	<b>On</b>	Automatically crops the photo to fit into the selected photo layout
	<b>Off</b>	Turns off automatic cropping
<b>Bidirectional</b>	<b>On</b>	Prints at normal speed
	<b>Off</b>	Slows down printing to improve print quality
<b>CD Inner/Outer</b>	Range of measurements	Selects inner and outer diameter for printing on CDs/DVDs from your camera
<b>CD Density</b>	<b>Standard</b>	Adjusts the print density when printing on CDs/DVDs from your camera
	<b>Darker</b>	
	<b>Darkest</b>	
<b>Clear All Settings</b>	<b>Yes</b>	Clears all print settings
	<b>No</b>	

**Parent topic:** [Selecting Print and Photo Adjustment Settings](#)

**Related references**

[Paper Type Settings - Copying](#)

### **Photo Adjustments - Camera**

Select the **Photo Adjustments** options you want to use when printing photos from your camera. The modifications affect only the printed copy of the photo, not the original file.

Photo Adjustments settings	Available options	Description
<b>Fix Photo</b>	<b>Fix Photo On</b>	Automatically adjusts the brightness, contrast, and saturation of the photo based on the <b>Scene Detection</b> setting that is selected
	<b>Fix Photo Off</b>	Turns off automatic adjustments; see <b>Note</b> below
	<b>P.I.M</b>	Uses your camera's PRINT Image Matching or Exif Print adjustments
<b>Scene Detection</b>	<b>Automatic</b>	Optimizes the <b>Fix Photo</b> adjustments for specific types of photos; select the option that best matches your photo content
	<b>People</b>	
	<b>Landscape</b>	
	<b>Night Scene</b>	
<b>Fix Red-Eye</b>	<b>Off</b>	Does not automatically fix the red-eye effect in photos
	<b>On</b>	Automatically fixes the red-eye effect in photos
<b>Filter</b>	<b>Off</b>	Turns off the filter setting
	<b>Sepia</b>	Applies a sepia tone filter to the viewed or printed photo
	<b>B&amp;W</b>	Applies a black-and-white filter to the viewed or printed photo
<b>Brightness</b>	Various settings	Adjust individual qualities in your photo
<b>Contrast</b>		
<b>Sharpness</b>		
<b>Saturation</b>		
<b>Clear All Settings</b>	<b>Yes</b>	Clears all photo adjustment settings
	<b>No</b>	

**Note:** **Fix Photo** uses a sophisticated face recognition technology to optimize photos that include faces. For this to work, both eyes and the nose must be visible in the subject's face. If your photo includes a face with an intentional color cast, such as a statue, you may want to turn off **Fix Photo** to retain the special color effects.

**Parent topic:** [Selecting Print and Photo Adjustment Settings](#)

## Connecting and Printing from a Camera

Before you connect your camera, make sure the product is turned on but not printing.

1. Remove any memory cards from the product.
2. Load the paper you want to use for printing.
3. Connect the USB cable that came with your camera to the  USB port on the front of your product.

**Note:** You cannot use the USB port to transfer images from your camera to your computer.

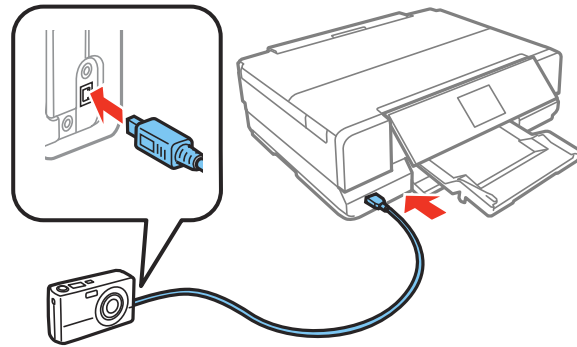

4. Turn on your camera.
  5. Follow the instructions that came with your camera to select and print your photos.
- When you finish printing, turn off your camera and disconnect it from the product.

**Parent topic:** [Printing from a Camera](#)

### Related tasks

[Removing a Memory Card](#)

### Related topics

[Loading Paper](#)

## Printing from a Camera Wirelessly

You can print photos from a digital camera using a wireless connection. Make sure your digital camera can connect to a network and is PictBridge compatible (DPS over IP).

1. Remove any memory cards from the product.
2. Load the paper you want to use for printing.
3. Turn on your camera.
4. Setup the camera's wireless network connection. See the documentation that came with your camera for details.

**Note:** Connect the camera to the same network that your product uses. You can print a Network Status sheet to view your product's network settings.

5. Follow the instructions that came with your camera to select and print your photos.

When you finish printing, turn off your camera and disconnect it from the network.

**Parent topic:** [Printing from a Camera](#)

**Related tasks**

[Removing a Memory Card](#)

[Printing a Network Status Sheet](#)

**Related topics**

[Loading Paper](#)

## Viewing or Printing from a USB Flash Drive or External Device

You can view and print photos from a USB thumb drive or other external storage device, such as an external hard drive or CD/DVD burner.

**Note:** Make sure the files on your device are compatible with the product.

[USB Device File Specifications](#)

[Connecting and Using a USB Flash Drive or External Device](#)

**Parent topic:** [Using an External Device with Your Product](#)

**Related tasks**

[Removing a Memory Card](#)

[Viewing and Printing Photos From the LCD Screen](#)

**Related topics**

[Loading Paper](#)

## USB Device File Specifications

You can print external device files that meet these specifications.

<b>File format</b>	JPEG with the Exif version 2.3 standard (taken with digital camera using DCF (Design rule for Camera File system) version 1.0 or 2.0 compliant)
<b>Image size</b>	80 × 80 pixels to 10200 × 10200 pixels
<b>File size</b>	Up to 2GB
<b>Number of files</b>	Up to 9990

**Note:** DCF 2.0 files stored in a camera's built-in memory are not supported.

**Parent topic:** [Viewing or Printing from a USB Flash Drive or External Device](#)

## Connecting and Using a USB Flash Drive or External Device

Before you connect your thumb drive or device, make sure the product is turned on but not printing.

**Note:** Epson cannot guarantee the compatibility of your drive.

1. Remove any memory cards from the product.
2. Load the paper you want to use for printing.
3. Insert your USB thumb drive or the USB cable that came with your device into the  USB port on the front of your product.
4. Insert storage media (such as a CD) into your drive, if necessary.
5. Select the photos to print from the LCD screen.

When you finish printing, make sure the access light on the drive is not flashing, then remove or disconnect it from the product.

**Caution:** Do not remove the USB drive or turn off the product when the access light is flashing, or you may lose photos on the drive.

**Parent topic:** [Viewing or Printing from a USB Flash Drive or External Device](#)

### Related tasks

[Removing a Memory Card](#)

**Related topics**

[Loading Paper](#)

---

# Printing Personalized Projects

You can print calendars, lined paper, graph paper, or stationery with a photo background.

[Printing Coloring Book Pages](#)

[Printing Personalized Note Paper](#)

[Printing Lined Paper, Graph Paper, and Music Sheets](#)

[Printing Calendar Pages](#)

## Printing Coloring Book Pages

You can create a coloring book page from a photo on your memory card, or from a photo or drawing placed on the scanner glass.

1. Load one of these types of paper in either Letter (8.5 × 11 inches [216 × 279 mm]) or A4 (8.3 × 11.7 inches [210 × 297 mm]) size:
  - Plain paper
  - Epson Bright White Paper
  - Epson Presentation Paper Matte
  - Epson Premium Presentation Paper Matte
  - Epson Velvet Fine Art Paper (letter-size only)
2. Press the  home button, if necessary.
3. Select **More Functions**.



4. Scroll down and select **Coloring Book**.

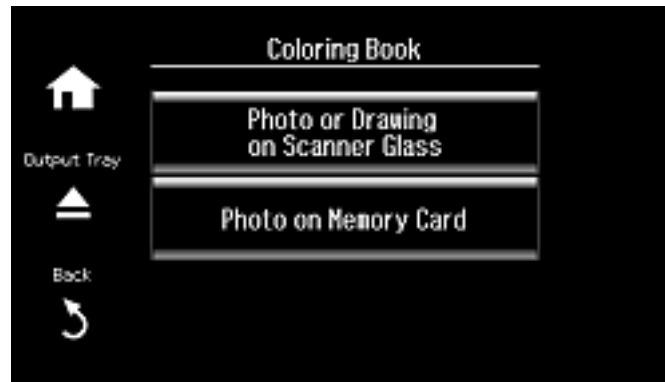

5. Do one of the following:
  - Select **Photo or Drawing on Scanner Glass** to print a design from an original placed facedown on the scanner glass, in the front right corner.
  - Select **Photo on Memory Card** to print a design from a memory card inserted in your product, then select a photo.
6. Select **Proceed**.
7. Select **Paper Settings** and select the size and type of paper that you loaded.
8. Select **Paper Source** and select where you loaded your paper.
9. If necessary, adjust the following settings:
  - **Density** to make the print lighter or darker
  - **Line Detection** to change the amount of detail in the print
10. When you are ready to print, press the **Start** button.

**Note:** To cancel printing, select **Cancel**.

**Parent topic:** [Printing Personalized Projects](#)

#### **Related tasks**

[Inserting a Memory Card](#)

[Placing Originals on the Scanner Glass](#)

## Related topics

[Loading Paper](#)

# Printing Personalized Note Paper

You can print lined or unlined note paper with one of your own photos in the background.

1. Load plain paper in either Letter (8.5 × 11 inches [216 × 279 mm]) or A4 (8.3 × 11.7 inches [210 × 297 mm]) size.
2. Insert a memory card into your product's memory card slot.
3. Press the  home button, if necessary.
4. Select **More Functions**.



5. Scroll down and select **Personal Stationery**.

6. Select **Writing Papers**.

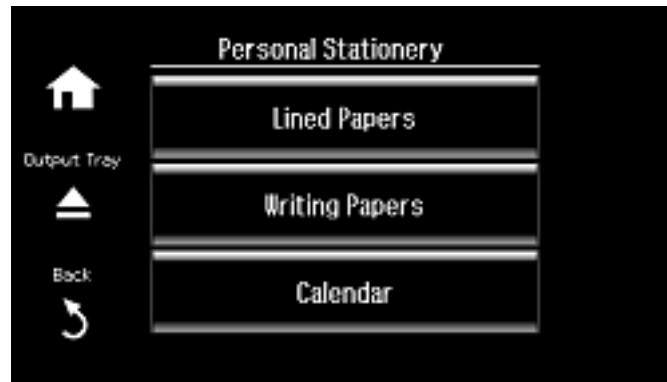

7. Scroll down and select one of the following settings:

- **Horizontal Rule**
- **Vertical Rule**
- **Without Rule**

**Note:** View the thumbnails next to each option to preview the design layout.

8. Select the size of paper you loaded.
9. Select the photo you want to use for your note paper and select **Proceed**.

**Note:** To rotate the layout, select **Rotate**.

10. When you see a message asking you to load paper, select **Proceed**.
11. To print more than one sheet, press the **+** or **-** button to select the number (up to 99).
12. When you are ready to print, press the **Start** button.

**Note:** To cancel printing, select **Cancel**.

**Parent topic:** [Printing Personalized Projects](#)

### Related tasks

[Inserting a Memory Card](#)

### Related topics

[Loading Paper](#)

## Printing Lined Paper, Graph Paper, and Music Sheets

You can print wide-rule or narrow-rule notebook paper and graph paper.

1. Load plain paper in either Letter (8.5 × 11 inches [216 × 279 mm]) or A4 (8.3 × 11.7 inches [210 × 297 mm]) size.
2. Press the  home button, if necessary.
3. Select **More Functions**.



4. Scroll down and select **Personal Stationery**.

5. Select **Lined Papers**.

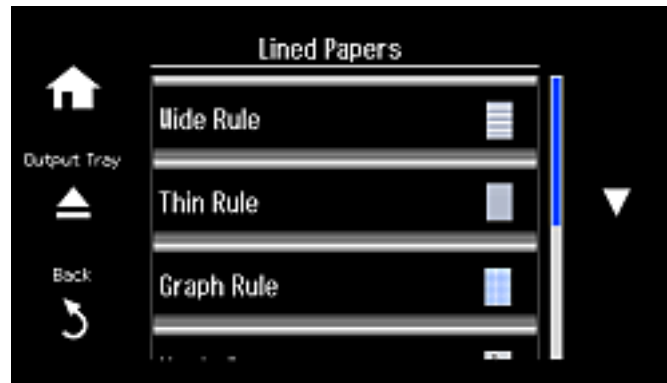

6. Select one of the following settings:

- **Wide Rule**
- **Thin Rule**
- **Graph Rule**
- **Music Paper**

**Note:** View the thumbnails next to each option to preview the design layout.

7. Select the size of paper you loaded.
8. When you see a message asking you to load paper, select **Proceed**.
9. To print more than one sheet, press the **+** or **-** button to select the number (up to 99).
10. When you are ready to print, press the **Start** button.

**Note:** To cancel printing, select **Cancel**.

**Parent topic:** [Printing Personalized Projects](#)

**Related topics**

[Loading Paper](#)

## Printing Calendar Pages

You can create and print a weekly or monthly calendar page from your product.

1. Load paper in either Letter (8.5 × 11 inches [216 × 279 mm]) or A4 (8.3 × 11.7 inches [210 × 297 mm]) size.
2. Press the  home button, if necessary.
3. Select **More Functions**.



4. Scroll down and select **Personal Stationery**.

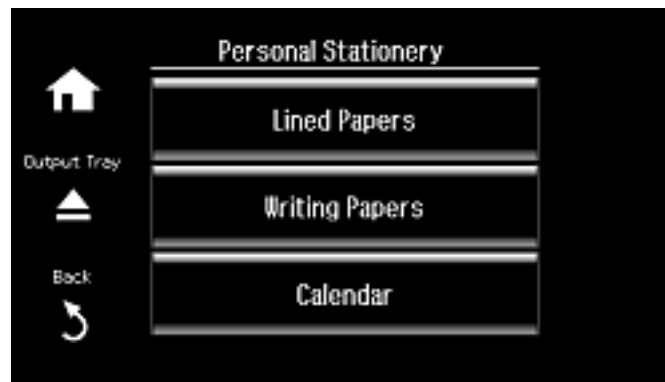

5. Select **Calendar**.
6. Select one of the following settings:
  - **Weekly**: prints a Sunday to Saturday week-long calendar with hourly divisions.
  - **Monthly**: prints a monthly calendar for a chosen month and year.
  - **Monthly with Photo**: prints a monthly calendar for a chosen month and year with a photo in the background.

**Note:** View the thumbnails next to each option to preview the design layout.

7. If you choose **Monthly**, enter the year and month and press **Done**.
8. Select the type and size of paper to print on.
9. When you see a message asking you to load paper, select **Proceed**.
10. To print more than one sheet, press the **+** or **-** button to select the number (up to 99).
11. When you are ready to print, press the **Start** button.

**Note:** To cancel printing, select **Cancel**.

**Parent topic:** [Printing Personalized Projects](#)

**Related topics**

[Loading Paper](#)

---

## Printing on CDs/DVDs

Follow the instructions here to print a design onto ink jet-printable CDs or DVDs to create a custom label.

[CD/DVD Printing Features](#)

[Loading a CD/DVD](#)

[Removing a Printed CD/DVD](#)

[Placing a CD/DVD on the Scanner Glass](#)

[Copying onto a CD/DVD](#)

[Printing Photos from a Memory Card Onto a CD/DVD](#)

[Printing a Jewel Case Insert from a Memory Card](#)

[Printing on CDs/DVDs from a Computer](#)

### CD/DVD Printing Features

You can use any of the following features to print custom CD/DVD/Blu-ray Disc labels and accessories:

- Copy an existing label onto a new CD/DVD/Blu-ray Disc
- Use your product's control panel to print photos from a memory card onto a CD/DVD/Blu-ray Disc
- Print text and images from your computer using the Epson Print CD software

You can also use your product's control panel to create a jewel case insert with photos from a memory card.

**Parent topic:** [Printing on CDs/DVDs](#)

#### Related tasks

[Copying onto a CD/DVD](#)

[Printing Photos from a Memory Card Onto a CD/DVD](#)

[Printing a Jewel Case Insert from a Memory Card](#)

### Loading a CD/DVD

You can print on any compatible, ink jet-printable CDs or DVDs, including Blu-ray Discs.

**Caution:** Do not insert the CD/DVD tray while the product is printing, copying, or performing other operations. Otherwise, your product may be damaged or the surface of the CD/DVD may become dirty or scratched.

**Note:** If you are using discs where the printable area extends to within 0.16 inch (4 mm) of the center hole, you may need to adjust the inner diameter setting using the control panel or Epson Print CD software.

1. Burn your files, music, or video onto your disc before printing on it.
2. Send print data from a computer, or use the control panel to print on the CD/DVD, and follow the on-screen instructions.
3. Raise the control panel all the way up.

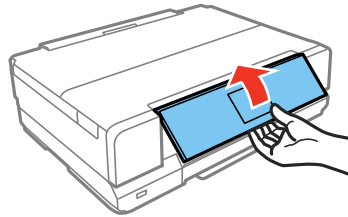

4. Make sure nothing is on the output tray, then close it.

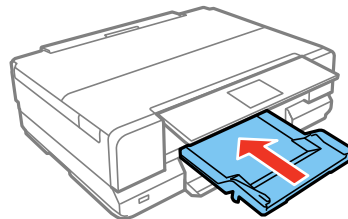

5. Close the front cover.

6. Remove the CD/DVD tray from the bottom of the product.

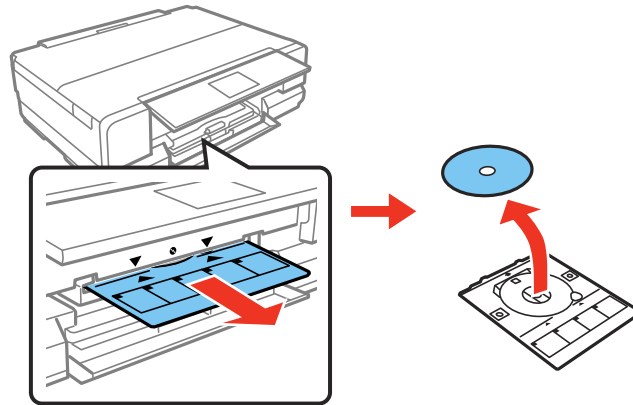

7. Place a CD or DVD on the CD/DVD tray with the printable side faceup, and insert the tray into the slot above the output tray.

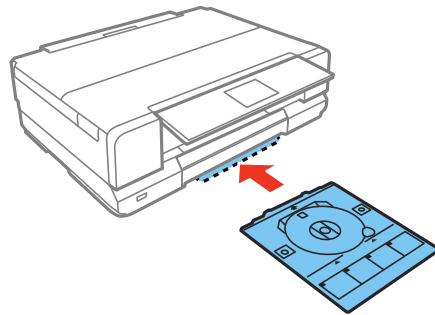

**Note:** Make sure the ▲ marks on the tray and the ▼ marks on the product line up.

8. Select **Ready** > **OK** on the touch panel.

**Note:** The CD/DVD tray ejects automatically after a certain period of time.

**Caution:** Do not turn off the product with a CD or DVD loaded in it. Always remove the disc first.

Parent topic: [Printing on CDs/DVDs](#)

## Removing a Printed CD/DVD

After your CD or DVD is printed, the tray extends automatically.

1. Pull the CD/DVD tray out of the product and remove your CD or DVD from the tray.

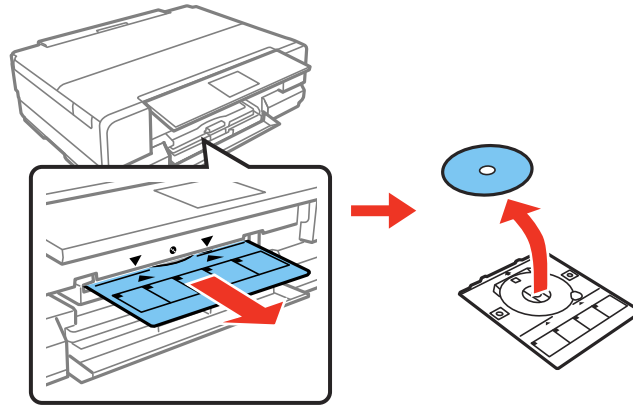

2. Insert the CD/DVD tray into the storage slot on the bottom of the product.

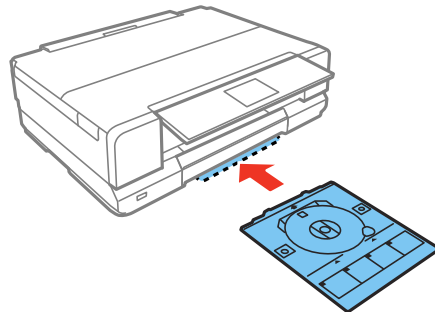

After printing, handle the CD or DVD carefully. You may need to wait up to 24 hours for the ink to dry fully before inserting it in a drive, depending on the type of disc you used. Keep printed discs away from moisture and direct sunlight.

Parent topic: [Printing on CDs/DVDs](#)

## Placing a CD/DVD on the Scanner Glass

You can place a CD or DVD on the scanner glass and copy the label design onto another CD or DVD.

1. Open the document cover.
2. Place your CD or DVD facedown in the center of the scanner glass.

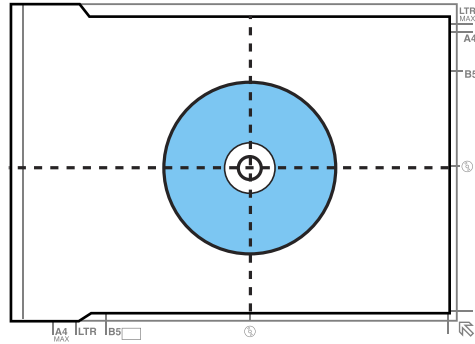

3. Close the document cover gently to keep your disc in place.

Parent topic: [Printing on CDs/DVDs](#)

## Copying onto a CD/DVD

You can copy a printed photo or CD/DVD label directly onto an ink jet-printable CD or DVD. If you want, you can first print a test design on plain paper.

1. Load the CD, DVD, or plain paper you want to print on.
2. Press the  home button, if necessary.

3. Select **More Functions**.



4. Select **CD/DVD Copy**.
5. Follow the instructions on the LCD screen to place your original CD, DVD, or photo on the scanner glass and select **Proceed**.
6. If necessary, adjust the inner and outer diameter of your CD as shown on the screen and select **Proceed**.

You see this screen:

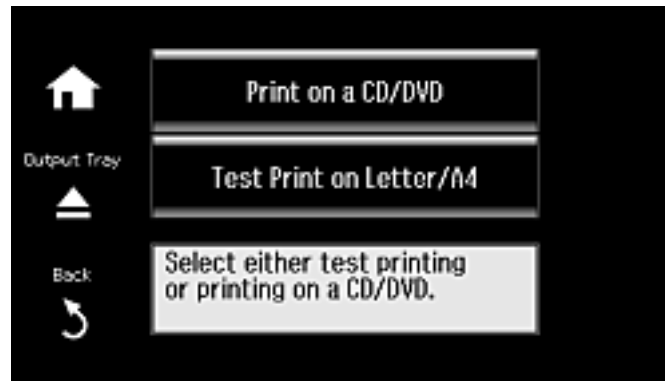

7. Select one of the options shown on the screen to print on a CD or DVD or a test print on plain paper. If printing on plain paper, select **Proceed**.

8. When you are ready to print, press the **Start** button.

**Note:** To cancel copying, select **Cancel**.

**Parent topic:** [Printing on CDs/DVDs](#)

**Related tasks**

[Loading a CD/DVD](#)

[Placing a CD/DVD on the Scanner Glass](#)

[Placing Originals on the Scanner Glass](#)

**Related topics**

[Loading Paper](#)

## Printing Photos from a Memory Card Onto a CD/DVD

You can print one or more photos from a memory card directly onto a CD or DVD. If you want, you can first print a test design on plain paper.

1. Insert a memory card into a memory card slot on your product.
2. Load the CD, DVD, or plain paper you want to print on.
3. Press the **Home** button, if necessary.
4. Select **More Functions**.



5. Select **Print on CD/DVD**.

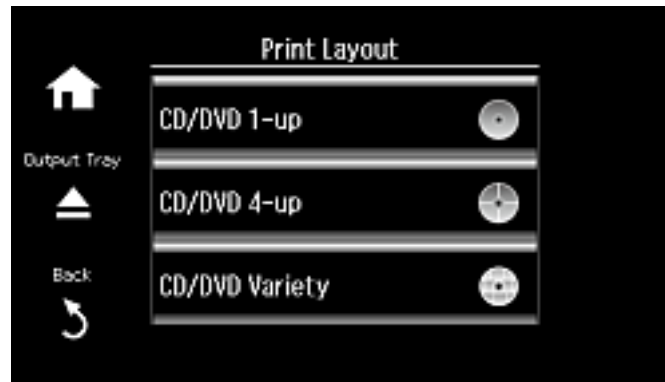

6. Select a layout and select **Proceed**.
7. Follow the instructions on the screen to select your photo or photos.
8. When you see the screen to adjust the inner and outer diameter of your CD, adjust the settings if necessary and select **Proceed**.

You see this screen:

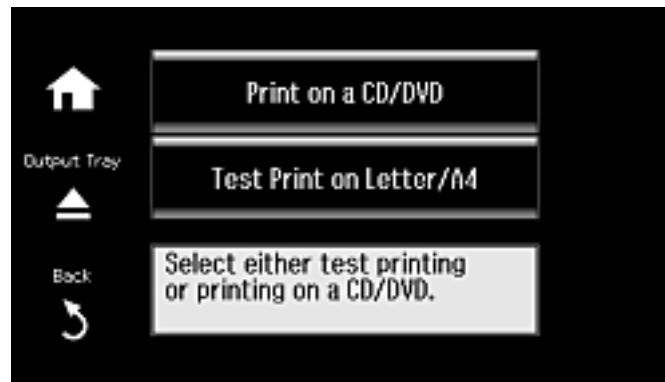

9. Select one of the options shown on the screen to print on a CD or DVD or a test print on plain paper. If printing on plain paper, select **Proceed**.

10. Adjust the **CD Density** setting if necessary, then press the **Start** button to print.

**Note:** To cancel printing, select **Cancel**.

**Parent topic:** [Printing on CDs/DVDs](#)

**Related tasks**

[Inserting a Memory Card](#)

[Loading a CD/DVD](#)

**Related topics**

[Loading Paper](#)

## Printing a Jewel Case Insert from a Memory Card

You can print a photo from a memory card, automatically sized to fit on a CD or DVD jewel case insert. You can also print thumbnail images formatted to fit on a jewel case insert. After the insert is printed, you can cut and fold it to fit.

1. Insert a memory card into a memory card slot on your product.
2. Load the paper you want to print on.
3. Press the **Home** button, if necessary.
4. Select **More Functions**.



5. Select **Photo Layout Sheet**.

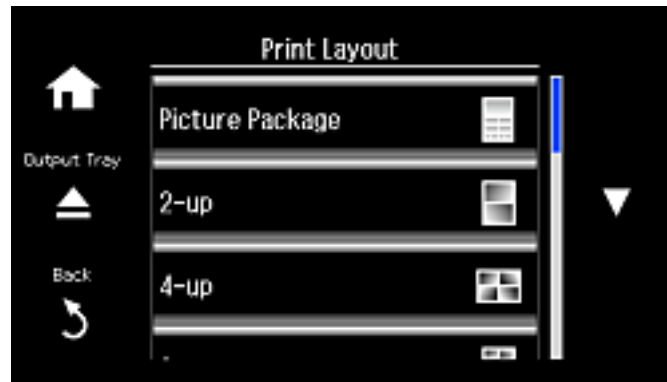

6. Scroll down and then select one of the following:
  - **Jewel Upper** to print one photo on the upper half of the insert.
  - **Jewel Index** to print 24 or 48 thumbnail images on the insert.
7. Select your paper size and type and select **Proceed**.
8. Follow the instructions on the LCD display to select your photos and set the number of copies.
9. When you see the Print Settings screen, change your print settings if necessary.
10. When you are ready to print, press the **Start** button.

**Note:** To cancel printing, select **Cancel**.

11. Cut and fold your insert following the crop lines.

**Parent topic:** [Printing on CDs/DVDs](#)

**Related tasks**

[Inserting a Memory Card](#)

**Related topics**

[Loading Paper](#)

## Printing on CDs/DVDs from a Computer

Before printing directly on CDs or DVDs from your computer, make sure you have set up your product as described on the *Start Here* sheet, and installed the Epson Print CD software.

[Starting Epson Print CD - Windows](#)

[Printing Your CD/DVD Design - Windows](#)

[Starting Epson Print CD - OS X](#)

[Printing Your CD/DVD Design - OS X](#)

**Parent topic:** [Printing on CDs/DVDs](#)

### Related tasks

[Loading a CD/DVD](#)

## Starting Epson Print CD - Windows

You can use Epson Print CD to design your disc by importing photos, adding text, and creating special effects.

1. Select the Epson Print CD icon on your Windows Desktop.

You see a screen like this:

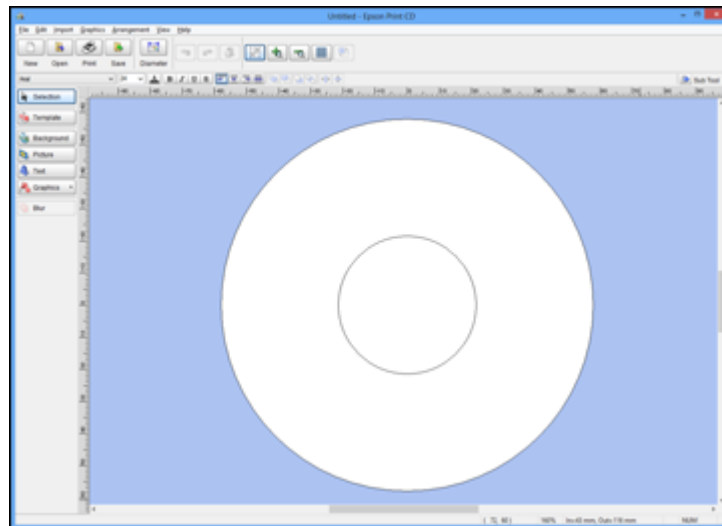

2. Use the buttons on the left side of the screen to select a pre-designed template or add a background image, picture, text, or graphic elements. For more information, select the **Help** menu.
3. When you are finished creating your design, click **Save** and save your design file.

**Parent topic:** [Printing on CDs/DVDs from a Computer](#)

## Printing Your CD/DVD Design - Windows

After you create your design, you can print it on paper to test it, then print it on the CD or DVD that contains your data, photos, video, or music. Make sure the disc is loaded for printing before you start.

1. Open your file in Epson Print CD and click **Print**.

You see a screen like this:

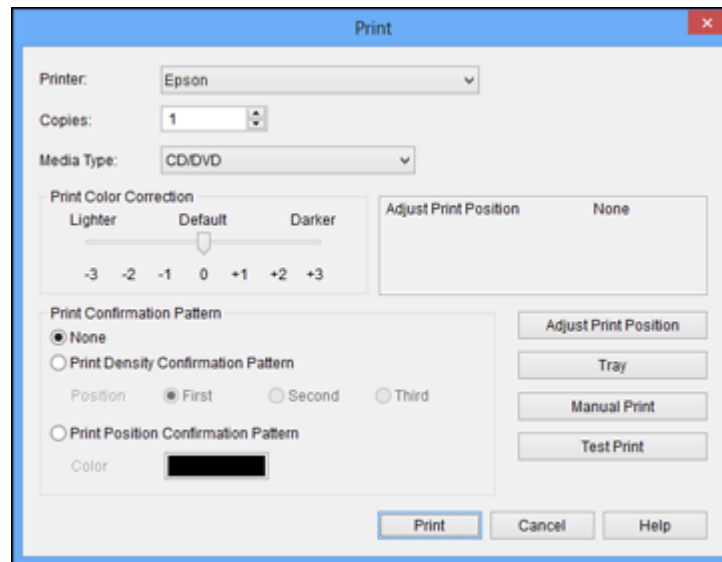

2. Make sure your product is selected as the **Printer** setting.
3. To see how your design will look without printing on the disc, click **Test Print** and follow the instructions on the screen.
4. When you are ready to print on the disc, click the **Print** button on the screen.
5. Click **Print**.

**Note:** If you need to adjust the print position or print quality, see the Epson Print CD Help utility for instructions.

**Parent topic:** [Printing on CDs/DVDs from a Computer](#)

## Starting Epson Print CD - OS X

You can use Epson Print CD to design your disc by importing photos, adding text, and creating special effects.

1. Open the Epson Print CD program in the **Applications > Epson Software > Print CD** folder on your Mac.

You see a screen like this:

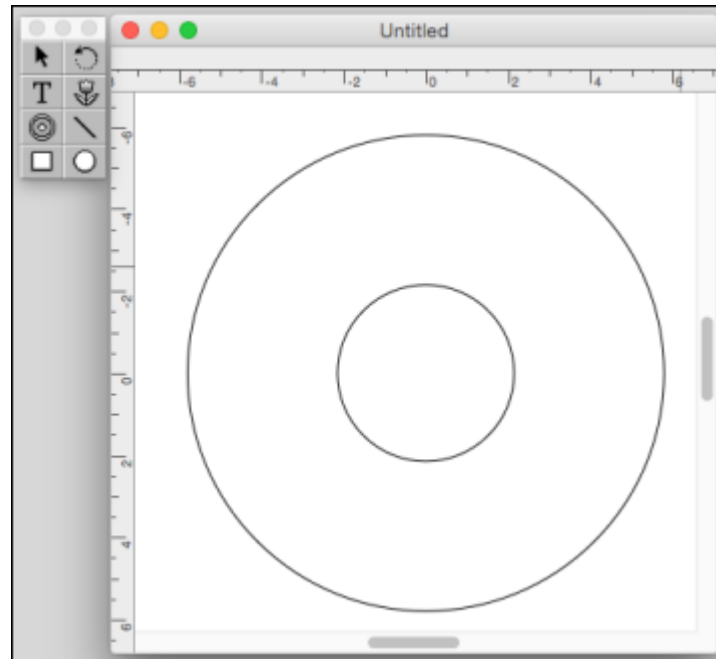

2. Use the icons on the left side of the screen to add a background image, picture, text, or graphic elements.
3. When you are finished creating your design, make sure you save it.

Parent topic: [Printing on CDs/DVDs from a Computer](#)

## Printing Your CD/DVD Design - OS X

After you create your design, you can print it on paper to test it, then print it on the CD or DVD that contains your data, photos, video, or music. Make sure the disc is loaded for printing before you start.

1. Open your file in Epson Print CD and select **Print** from the File menu.

You see a screen like this:

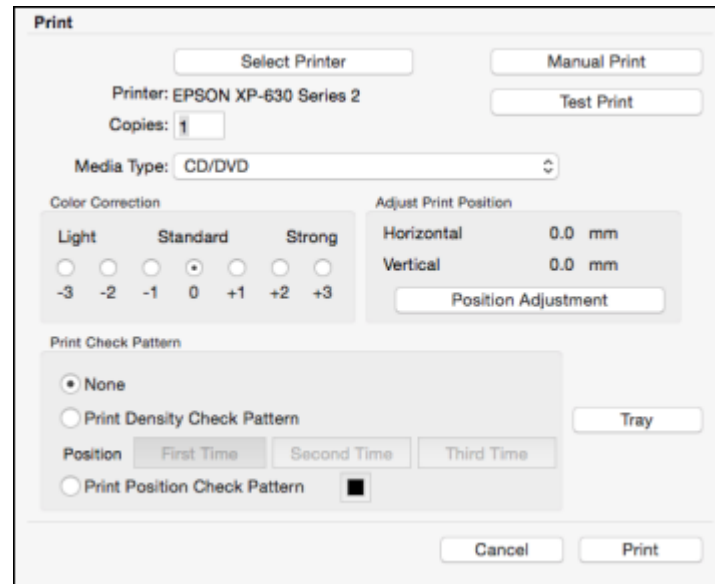

2. Make sure your product is selected as the **Printer** setting.
3. To see how your design will look without printing on the disc, select **Test Print** and follow the instructions on the screen.
4. When you are ready to print on the disc, click the **Print** button on the screen.

**Note:** If you need to adjust the print position or print quality, see the Epson Print CD Help utility for instructions.

Parent topic: [Printing on CDs/DVDs from a Computer](#)

---

# Replacing Ink Cartridges

When an ink cartridge is expended, you need to replace it.

You may also need to replace a cartridge that is more than six months old, or if your printouts do not look their best, even after cleaning and aligning the print head.

**Note:** Please dispose of your used Epson branded ink cartridges responsibly and in accordance with local requirements. If you would like to return your used ink cartridges to Epson for proper disposal, please go to [epson.com/recycle](https://www.epson.com/recycle) for more information.

[Check Cartridge Status](#)

[Purchase Epson Ink Cartridges](#)

[Removing and Installing Ink Cartridges](#)

[Printing with Black Ink and Expended Color Cartridges](#)

[Conserving Low Black Ink with Windows](#)

## Check Cartridge Status

Your product and its printing software will let you know when an ink cartridge is low or expended.

[Checking Cartridge Status on the LCD Screen](#)

[Checking Cartridge Status with Windows](#)

[Checking Cartridge Status with OS X](#)

**Parent topic:** [Replacing Ink Cartridges](#)

## Checking Cartridge Status on the LCD Screen

You can check the status of your ink cartridges using your product's LCD screen.

1. Press the  home button, if necessary.

2. Select **Setup**.



3. Select **Ink Levels**.  
The ink cartridge status is displayed.

**Note:** Displayed ink levels are approximate.

4. Select **OK** to exit.

**Parent topic:** [Check Cartridge Status](#)

**Related tasks**

[Removing and Installing Ink Cartridges](#)

## Checking Cartridge Status with Windows

A low ink reminder appears if you try to print when ink is low, and you can check your cartridge status at any time using a utility on your Windows computer.

1. To check your cartridge status, access the Windows Desktop and double-click the product icon in the Windows taskbar.

You see this window:

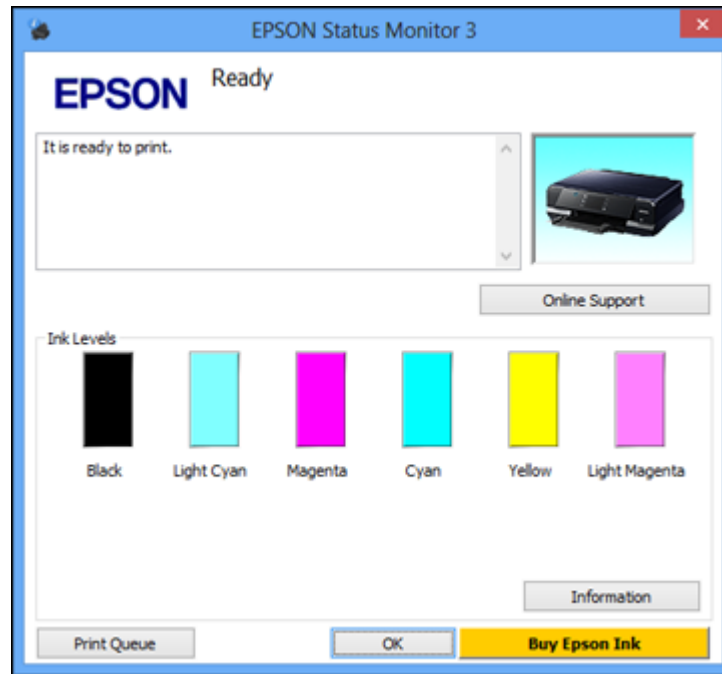

2. Replace or reinstall any ink cartridge indicated on the screen.

**Note:** Depending on the color of the expended cartridge and how you are printing, you may be able to continue printing temporarily.

**Note:** If any of the cartridges installed in the product are broken, incompatible with the product model, or improperly installed, Epson Status Monitor will not display an accurate cartridge status.

3. To disable the low ink reminder, right-click the product icon in the Windows taskbar and select **Monitoring Preferences**.

You see this window:

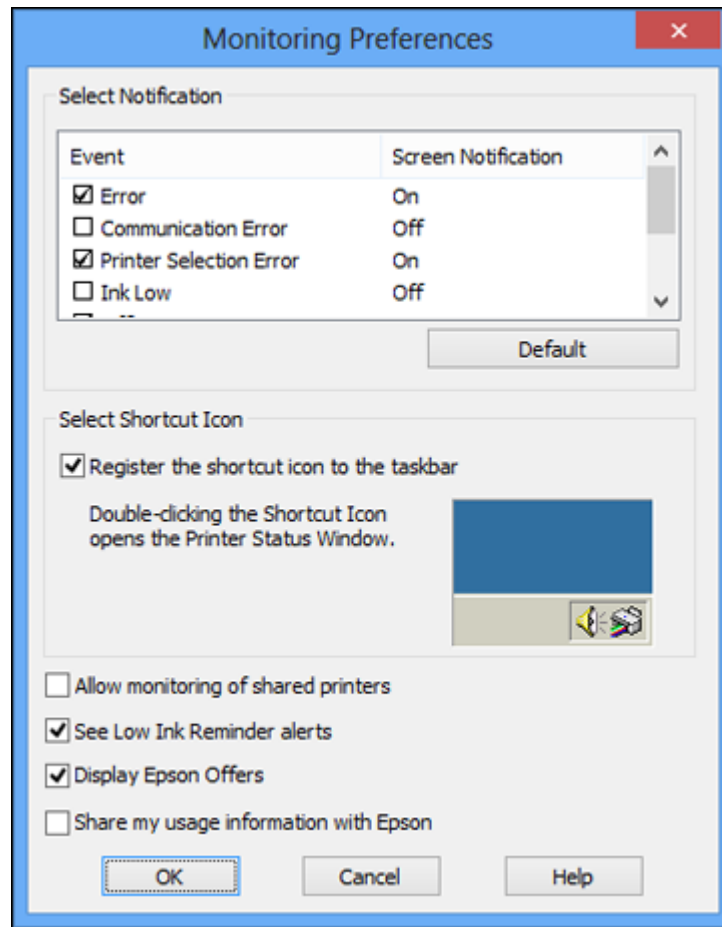

4. Deselect the **See Low Ink Reminder alerts** checkbox at the bottom of the screen.
5. To disable promotional offers, deselect the **Display Epson Offers** checkbox.

**Parent topic:** [Check Cartridge Status](#)

#### **Related tasks**

[Removing and Installing Ink Cartridges](#)

## Checking Cartridge Status with OS X

You can check your cartridge status using a utility on your Mac.

1. In the Apple menu or the Dock, select **System Preferences**. Select **Print & Fax**, **Print & Scan**, or **Printers & Scanners**, select your product, and select **Options & Supplies**. Select **Utility** and select **Open Printer Utility**.
2. Select **EPSON Status Monitor**.

You see a window like this:

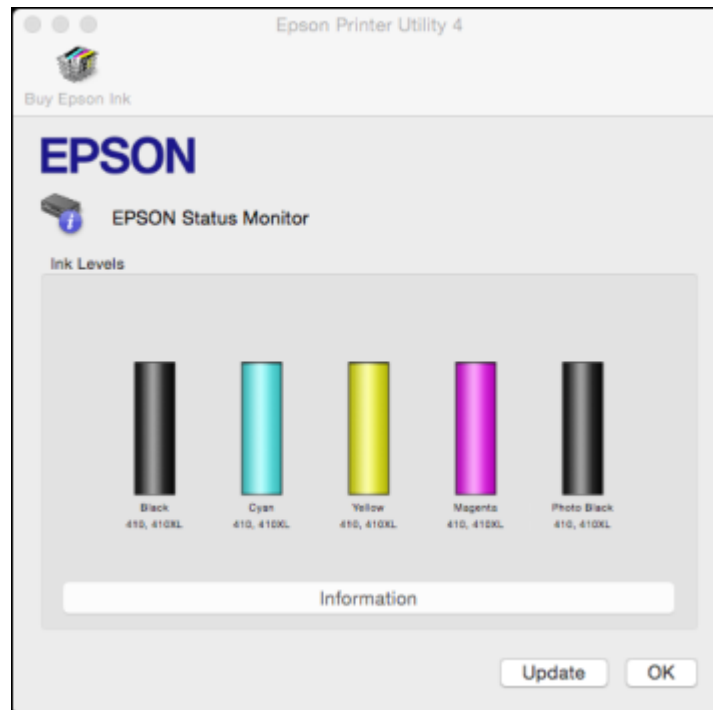

3. Do the following as necessary:
  - To update the ink cartridge status, click **Update**.

- Replace or reinstall any ink cartridge indicated on the screen.

**Note:** Depending on the color of the expended cartridge and how you are printing, you may be able to continue printing temporarily.

**Note:** If any of the cartridges installed in the product is broken, incompatible with the product model, or improperly installed, Epson Status Monitor will not display an accurate cartridge status.

**Parent topic:** [Check Cartridge Status](#)

**Related tasks**

[Removing and Installing Ink Cartridges](#)

## Purchase Epson Ink Cartridges

You can purchase genuine Epson ink and paper at [epson.com/ink3](http://epson.com/ink3) (U.S. sales) or [epson.ca](http://epson.ca) (Canadian sales). You can also purchase supplies from an Epson authorized reseller. To find the nearest one, call 800-GO-EPSON (800-463-7766).

**Note:** This product uses only genuine Epson-brand cartridges. Other brands of ink cartridges and ink supplies are not compatible and, even if described as compatible, may not function properly.

The cartridge included with the printer is designed for printer setup and not for resale. After some ink is used for charging, the rest is available for printing. Yields vary considerably based on images printed, print settings, paper type, frequency of use, and temperature. For print quality, a variable amount of ink remains in the cartridge after the "replace cartridge" indicator comes on.

[Ink Cartridge Part Numbers](#)

**Parent topic:** [Replacing Ink Cartridges](#)

## Ink Cartridge Part Numbers

Use these part numbers when you order or purchase new ink cartridges.

**Note:** For best printing results, use up a cartridge within 6 months of opening the package.

Ink color	Part number	
	Standard-capacity	High-capacity
Photo Black (PBK)	277	277XL

Ink color	Part number	
	Standard-capacity	High-capacity
Black (BK)	277	277XL
Cyan	277	277XL
Magenta	277	277XL
Yellow	277	277XL

Parent topic: [Purchase Epson Ink Cartridges](#)

## Removing and Installing Ink Cartridges

Make sure you have your replacement cartridges handy before you begin. You must install new cartridges immediately after removing the old ones.

**Caution:** Leave your old cartridges in the printer until you are ready to replace them to prevent the print head nozzles from drying out. Do not open ink cartridge packages until you are ready to install the ink. Cartridges are vacuum packed to maintain reliability.

1. Make sure that the CD/DVD tray is not inserted for printing.
2. Turn on your product.
  - If an ink cartridge is expended, you see a message on the LCD screen. Note which cartridges need to be replaced and select **Proceed**. Then choose **Yes, replace now**.
  - If you are replacing a cartridge before you see a message on the LCD screen, select **Setup > Maintenance > Ink Cartridges Replacement**.
3. Lift up the scanner unit.

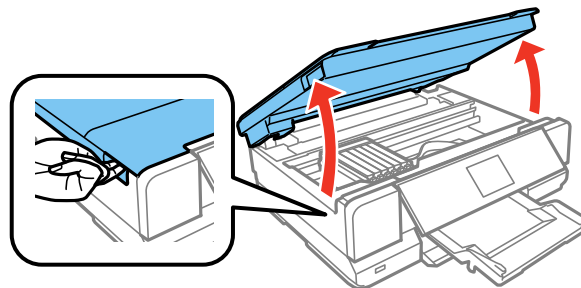

**Caution:** Do not move the print head by hand; otherwise, you may damage your product. Do not touch the flat white cable inside the printer.

4. Push in the blue tab to unlock the ink cartridge you are replacing. Then lift the bottom of the ink cartridge to remove it.

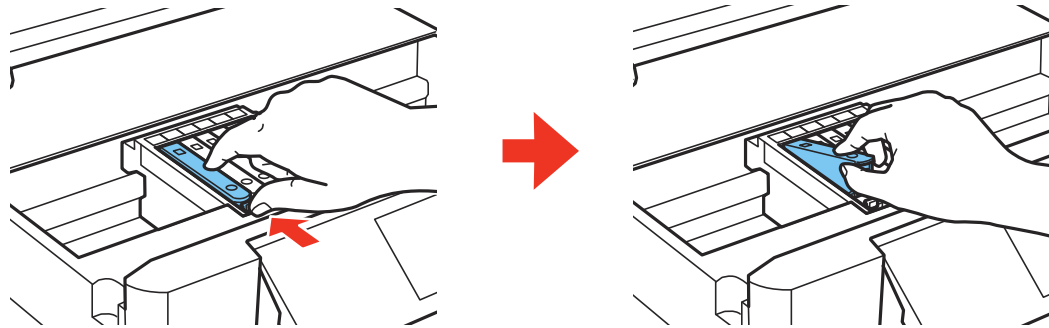

**Warning:** If ink gets on your skin, wash it thoroughly with soap and water. If ink gets into your eyes, flush them immediately with water. If ink gets into your mouth, spit it out and see a doctor right away. Keep ink cartridges out of the reach of children.

5. Recap the used ink cartridge using the cap that came with it.

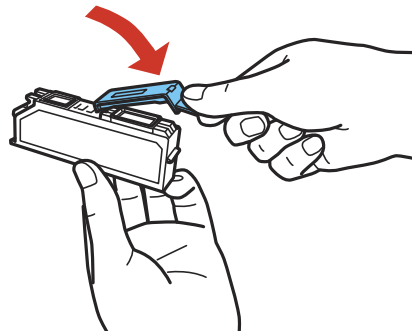

**Note:** Dispose of used cartridges carefully. Do not take the used cartridge apart or try to refill it.

6. Remove the new ink cartridge from the package.

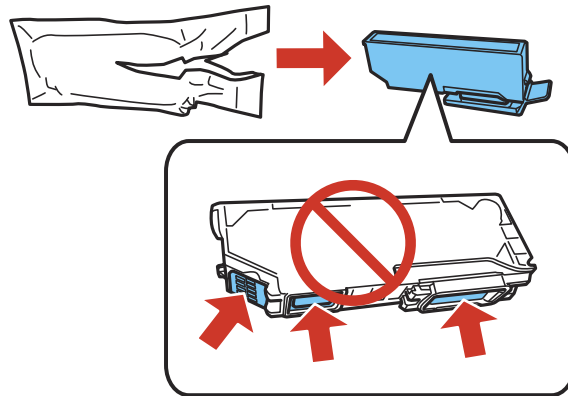

**Caution:** Do not shake the cartridges after opening the packages, or ink may leak. Do not touch the areas shown above. Doing so may prevent normal operation and printing.

7. Remove the cap from the cartridge and store it for later use.

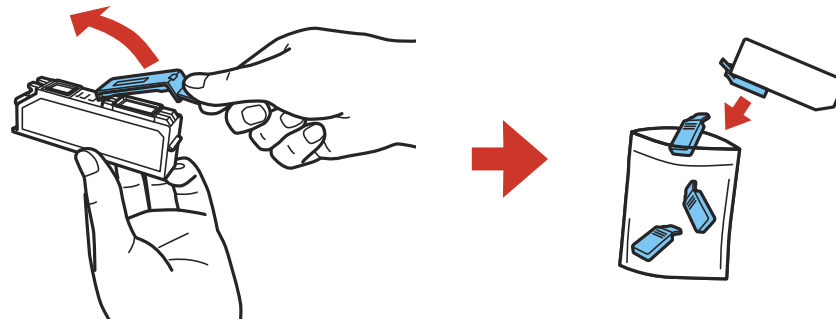

**Note:** Save the cap so you can recap ink cartridges before storing or disposing of them.

**Caution:** Do not remove any other labels or seals, or ink will leak.

8. Insert the ink cartridge head first into the ink cartridge holder. Then press the bottom of the ink cartridge down until it clicks into place.

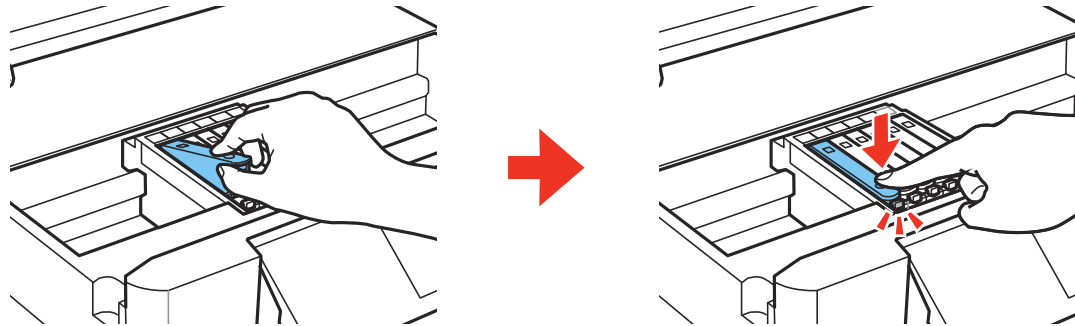

9. Once you replace all the cartridges that need replacing, close the scanner unit.

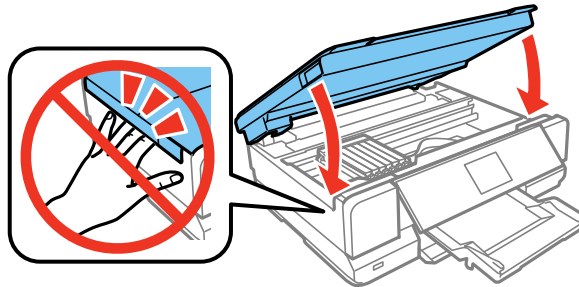

The product starts charging the ink. This takes a few minutes. When you see a completion message on the LCD screen, ink replacement is complete.

**Note:** Do not turn off the product while it is charging or you will waste ink. If you see an error screen telling you an ink cartridge is installed incorrectly, lift up the scanner unit and press the ink cartridge down until it clicks into place. When you're finished, close the scanner unit.

If you remove a low or expended ink cartridge, you cannot re-install and use the cartridge.

**Caution:** If you remove an ink cartridge for later use, recap the ink cartridge using the cap that came with it to prevent the ink from drying out and to protect the surrounding area from getting smeared by ink. Store the ink cartridge in the same environment as the product. Do not leave the product with the ink

cartridges removed for an extended period of time. Otherwise, ink remaining in the print head nozzles may dry out and you may not be able to print.

**Parent topic:** [Replacing Ink Cartridges](#)

**Related concepts**

[Purchase Epson Ink Cartridges](#)

## Printing with Black Ink and Expended Color Cartridges

When a color or photo black ink cartridge is expended, you can temporarily continue printing from your computer using black ink. Replace the expended cartridge as soon as possible for future printing.

**Note:** You cannot print with expended color ink cartridges using your product's control panel.

[Printing with Expended Color Cartridges - Windows](#)

[Printing with Expended Color Cartridges - OS X](#)

**Parent topic:** [Replacing Ink Cartridges](#)

**Related tasks**

[Removing and Installing Ink Cartridges](#)

## Printing with Expended Color Cartridges - Windows

If you see a message during printing telling you that you can temporarily print in black ink with an expended color cartridge, you can cancel your print job and select settings to print on plain paper or on an envelope.

**Note:** To use this feature, Epson Status Monitor must be enabled.

1. Click **Cancel** or **Cancel Print** to cancel your print job.

**Note:** If the message screen appears on another computer on a network, you may need to cancel the print job using the product control panel.

2. Load plain paper or an envelope in your product.
3. Access the print settings in your print application.
4. Click the **Main** tab.
5. Select **Plain Paper/Bright White Paper** or **Envelope** as the paper type setting.

6. Select the **Black/Grayscale** checkbox.
7. Click **OK**.
8. Print your document.  
Epson Status Monitor 3 displays a print message.
9. Click **Print in Black** to print your document.

**Parent topic:** [Printing with Black Ink and Expended Color Cartridges](#)

**Related topics**

[Loading Paper](#)

## Printing with Expended Color Cartridges - OS X

If printing stops, you can cancel your print job and select settings to temporarily print with only black ink on plain paper or on an envelope.

1. Click the printer icon in the Dock.
2. If you see a message telling you that you can temporarily print with only black ink, click the **Delete** or  button to cancel your print job. If you see an error message, click **OK**.

**Note:** If the message screen appears on another computer on a network, you may need to cancel the print job using the product control panel.

3. In the Apple menu or the Dock, select **System Preferences**.
4. Select **Print & Fax**, **Print & Scan**, or **Printers & Scanners**, select your product, and select **Options & Supplies**.
5. Select **Driver** or **Options**.

You see a screen like this:

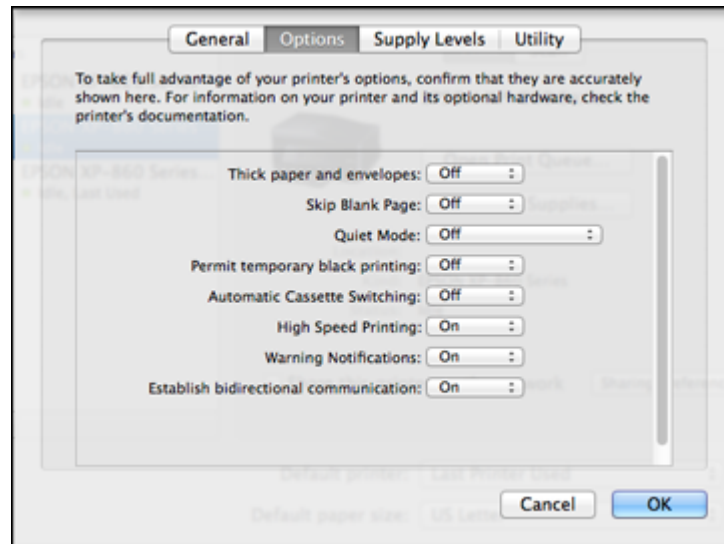

6. Select **On** as the **Permit temporary black printing** setting.
7. Click **OK** or **OK**.
8. Close the utility window.
9. Load plain paper or an envelope in your product.
10. Access the print settings in your print application.
11. Select **Print Settings** from the pop-up menu.
12. Select **Plain Paper/Bright White Paper** or **Envelope** as the paper type setting.
13. Select the **Grayscale** option.
14. Click **Print** to print your document.

**Parent topic:** [Printing with Black Ink and Expended Color Cartridges](#)

#### **Related topics**

[Loading Paper](#)

## Conserving Low Black Ink with Windows

The following window appears when black ink runs low and there is more color ink.

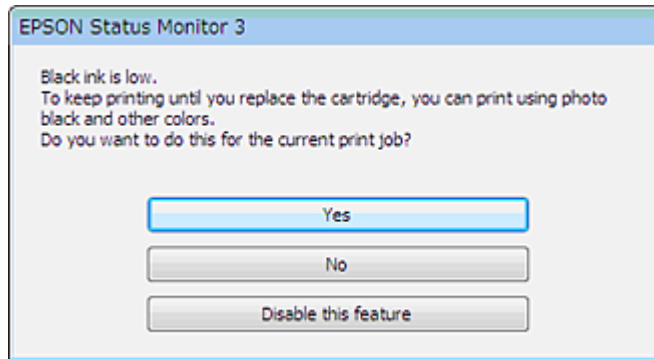

**Note:** The window appears only when you have selected **Plain Paper/Bright White Paper** as the paper type setting, and depends on other selected print settings. To use this feature, Epson Status Monitor must be enabled.

- Click **Yes** to use a mixture of color inks to create black, or **No** to continue using the remaining black ink for the document you are printing.
- Click **Disable this feature** to continue using the remaining black ink.

**Note:** If you disable this feature, it remains disabled until you install a new black ink cartridge.

**Parent topic:** [Replacing Ink Cartridges](#)

---

## Adjusting Print Quality

If your print quality declines, you may need to run a utility to clean or align the print head.

If running these utilities does not solve the problem, you may need to replace the ink cartridges.

[Print Head Maintenance](#)

[Print Head Alignment](#)

[Cleaning the Paper Path](#)

### Print Head Maintenance

If your printouts become too light, or you see dark or light bands across them, you may need to clean the print head nozzles. Cleaning uses ink, so clean the nozzles only if print quality declines.

You can check for clogged nozzles before you clean them so you don't clean them unnecessarily.

**Note:** You cannot clean the print head if an ink cartridge is expended, and may not be able to clean it when a cartridge is low. You must replace the cartridge first.

[Print Head Nozzle Check](#)

[Print Head Cleaning](#)

**Parent topic:** [Adjusting Print Quality](#)

**Related topics**

[Replacing Ink Cartridges](#)

### Print Head Nozzle Check

You can print a nozzle check pattern to check for clogged nozzles.

[Checking the Nozzles Using the Product Control Panel](#)

[Checking the Nozzles Using a Computer Utility](#)

**Parent topic:** [Print Head Maintenance](#)

#### Checking the Nozzles Using the Product Control Panel

You can check the print head nozzles using the control panel on your product.

1. Make sure there are no errors on the LCD screen, the CD/DVD tray is not inserted for printing, and the output tray is extended.
2. Load a few sheets of plain paper in the product.

3. Press the  home button, if necessary.
4. Select **Setup**.
5. Select **Maintenance**.



6. Select **Nozzle Check**.

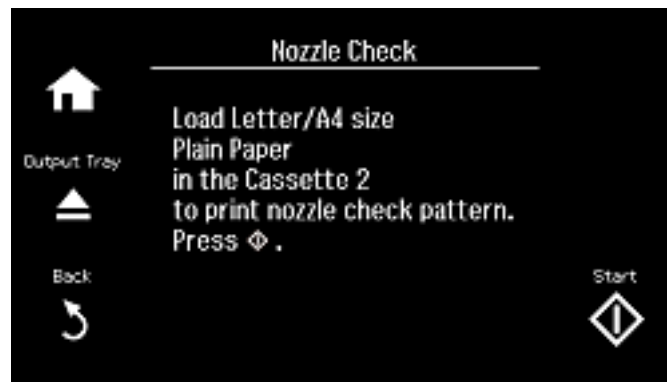

7. Press the  **Start** button.  
The nozzle check pattern is printed.

8. Check the printed pattern to see if there are gaps in the lines.

**Print head is clean**

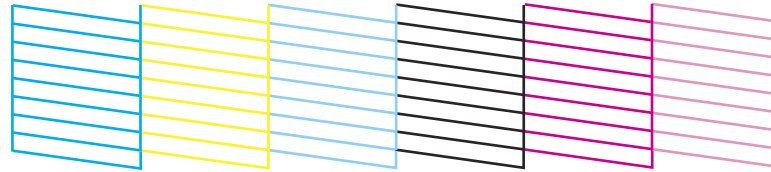

**Print head needs cleaning**

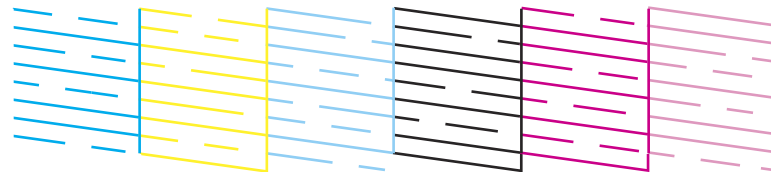

9. Do one of the following:
  - If there are no gaps, the print head is clean. Select **Done**.
  - If there are gaps or the pattern is faint, select **Clean the Print Head**.
10. Follow the instructions on the screen to clean the print head.

If you don't see any improvement after cleaning the print head up to 2 times, turn off the product and wait at least 6 hours. Then try cleaning the print head again. If quality still does not improve, one of the ink cartridges may be old or damaged and needs to be replaced.

**Parent topic:** [Print Head Nozzle Check](#)

**Related tasks**

[Loading Paper in Cassette 2 \(Lower Cassette\)](#)

[Cleaning the Print Head Using the Product Control Panel](#)

**Related topics**

[Replacing Ink Cartridges](#)

**Checking the Nozzles Using a Computer Utility**

You can check the print head nozzles using a utility on your Windows or Mac computer.

1. Make sure there are no errors on the LCD screen, the CD/DVD tray is not inserted for printing, and the output tray is extended.
2. Load a few sheets of plain paper in the product.
3. Do one of the following:
  - **Windows:** Access the Windows Desktop and right-click the product icon in the Windows taskbar.
  - **OS X:** In the Apple menu or the Dock, select **System Preferences**. Select **Print & Fax**, **Print & Scan**, or **Printers & Scanners**, select your product, and select **Options & Supplies**. Select **Utility** and select **Open Printer Utility**.
4. Select **Nozzle Check**.

You see a window like this:

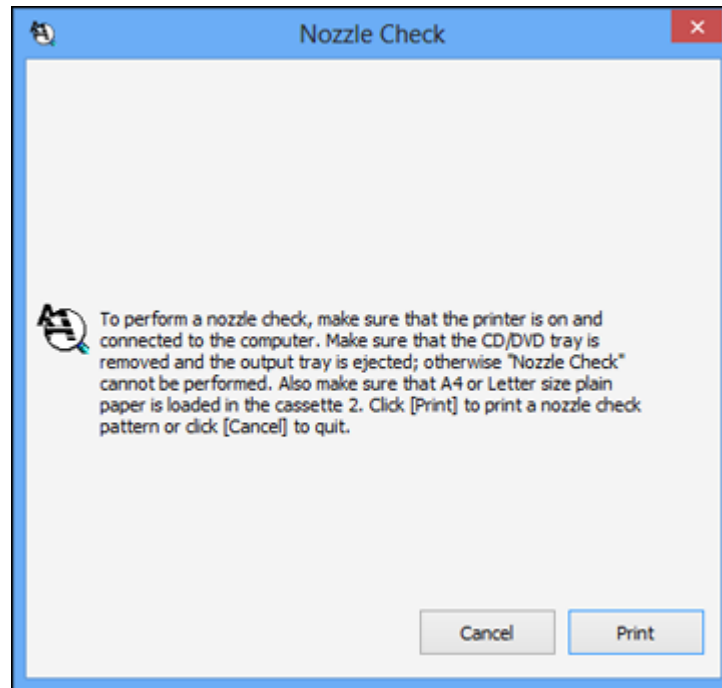

5. Click **Print**.

6. Check the printed pattern to see if there are gaps in the lines.

**Print head is clean**

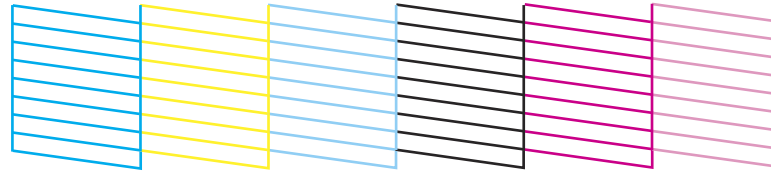

**Print head needs cleaning**

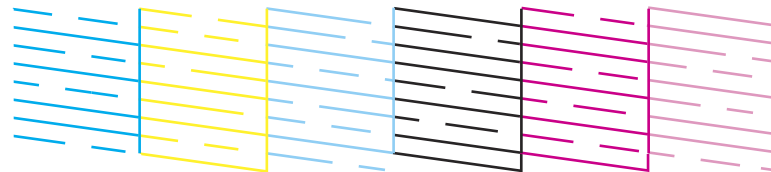

7. If there are no gaps, click **Finish**.

If there are gaps or the pattern is faint, clean the print head.

**Parent topic:** [Print Head Nozzle Check](#)

**Related tasks**

[Loading Paper in Cassette 2 \(Lower Cassette\)](#)

[Cleaning the Print Head Using a Computer Utility](#)

**Related topics**

[Replacing Ink Cartridges](#)

## Print Head Cleaning

If print quality has declined and the nozzle check pattern indicates clogged nozzles, you can clean the print head.

**Note:** You cannot clean the print head if an ink cartridge is expended, and may not be able to clean it when a cartridge is low. You must replace the cartridge first.

[Cleaning the Print Head Using the Product Control Panel](#)  
[Cleaning the Print Head Using a Computer Utility](#)

**Parent topic:** [Print Head Maintenance](#)

**Related topics**

[Replacing Ink Cartridges](#)

### **Cleaning the Print Head Using the Product Control Panel**

You can check the print head nozzles using the control panel on your product.

1. Make sure there are no errors on the LCD screen, the CD/DVD tray is not inserted for printing, and the output tray is extended.
2. Load a few sheets of plain paper in the product.
3. Press the  home button, if necessary.
4. Select **Setup**.
5. Select **Maintenance**.



6. Select **Head Cleaning**.



7. Press the **Start** button to clean the print head. You see a message on the LCD screen during the cleaning cycle.

**Caution:** Never turn off the product during a cleaning cycle or you may damage it.

When the cleaning cycle is finished, you see a message on the display screen.

8. Select **Print Nozzle Check Pattern**, then press the **Start** button to run a nozzle check and confirm that the print head is clean.

If you don't see any improvement after cleaning the print head up to 2 times, turn off the product and wait at least 6 hours. Then try cleaning the print head again. If quality still does not improve, one of the ink cartridges may be old or damaged and needs to be replaced.

**Parent topic:** [Print Head Cleaning](#)

#### **Related tasks**

[Loading Paper in Cassette 2 \(Lower Cassette\)](#)

[Checking the Nozzles Using the Product Control Panel](#)

#### **Related topics**

[Replacing Ink Cartridges](#)

### **Cleaning the Print Head Using a Computer Utility**

You can clean the print head using a utility on your Windows computer or Mac.

1. Make sure there are no errors on the LCD screen, the CD/DVD tray is not inserted for printing, and the output tray is extended.
2. Load a few sheets of plain paper in the product.
3. Do one of the following:
  - **Windows:** Right-click the product icon in the Windows taskbar.
  - **OS X:** In the Apple menu or the Dock, select **System Preferences**. Select **Print & Fax**, **Print & Scan**, or **Printers & Scanners**, select your product, and select **Options & Supplies**. Select **Utility** and select **Open Printer Utility**.
4. Select **Head Cleaning**.

You see a window like this:

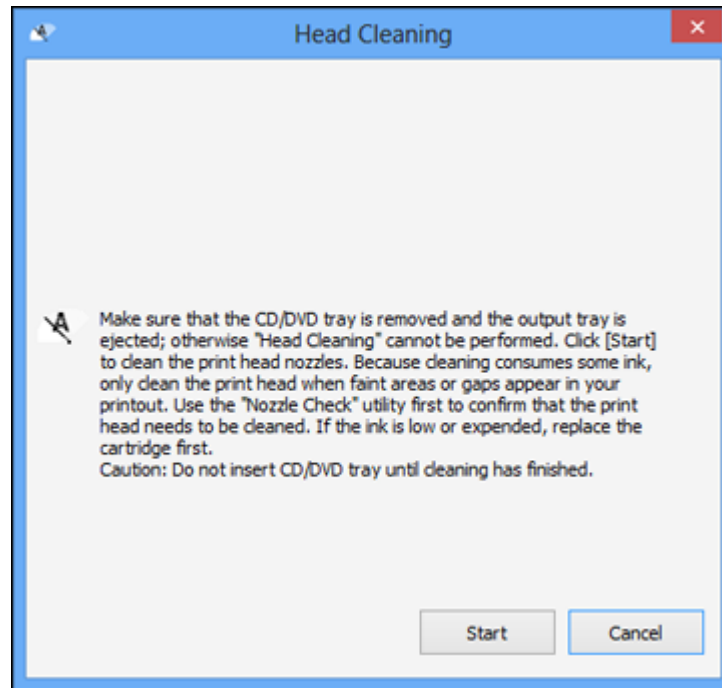

5. Click **Start** to begin the cleaning cycle.  
You see a message on the LCD screen during the cleaning cycle.

**Caution:** Never turn off the product during a cleaning cycle or you may damage it.

- When the cleaning cycle is finished, you can check to see if the nozzles are clean; click **Print Nozzle Check Pattern** and click **Print**.
- Check the printed pattern to see if there are gaps in the lines.

**Print head is clean**

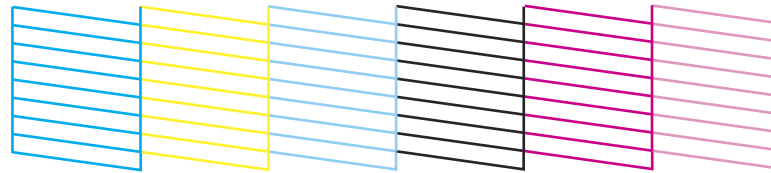

**Print head needs cleaning**

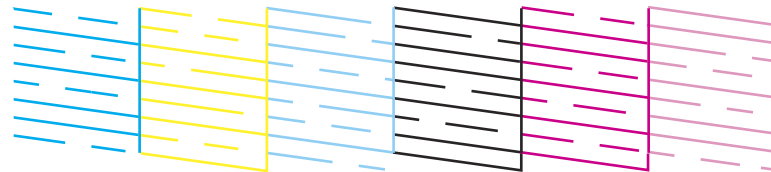

- If there are no gaps, click **Finish**.
- If there are gaps or the pattern is faint, click **Clean** to clean the print head again.

If you don't see any improvement after cleaning the print head up to 2 times, turn off the product and wait at least 6 hours. Then try cleaning the print head again. If quality still does not improve, one of the ink cartridges may be old or damaged and needs to be replaced.

**Parent topic:** [Print Head Cleaning](#)

**Related tasks**

[Loading Paper in Cassette 2 \(Lower Cassette\)](#)

[Checking the Nozzles Using a Computer Utility](#)

**Related topics**

[Replacing Ink Cartridges](#)

## Print Head Alignment

If your printouts become grainy or blurry, you notice misalignment of vertical lines, or you see dark or light horizontal bands, you may need to align the print head.

**Note:** Banding may also occur if your print head nozzles need cleaning.

[Aligning the Print Head Using the Product Control Panel](#)

[Aligning the Print Head Using a Computer Utility](#)

**Parent topic:** [Adjusting Print Quality](#)

### Aligning the Print Head Using the Product Control Panel

You can align the print head using the control panel on your product.

1. Make sure there are no errors on the LCD screen, the CD/DVD tray is not inserted for printing, and the output tray is extended.
2. Load a few sheets of plain paper in the product.
3. Press the  home button, if necessary.
4. Select **Setup**.
5. Select **Maintenance**.



6. Select **Print Head Alignment**.

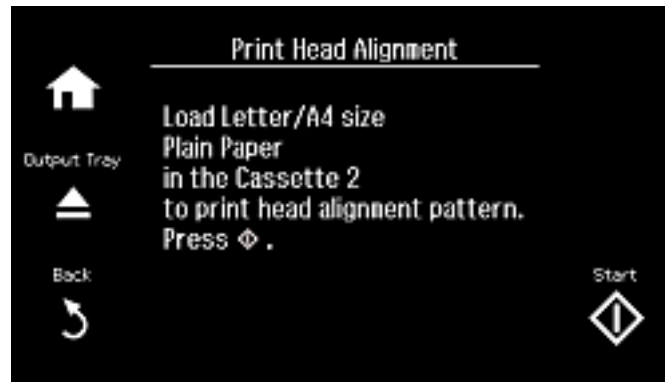

7. Press the ⬠ **Start** button to print an alignment sheet.

**Note:** Do not cancel printing while you are printing a head alignment pattern.

8. Check the printed pattern and select the number representing the best printed pattern for each set.
9. Select **Done** when you are finished.

**Parent topic:** [Print Head Alignment](#)

#### **Related tasks**

[Loading Paper in Cassette 2 \(Lower Cassette\)](#)

## **Aligning the Print Head Using a Computer Utility**

You can align the print head using a utility on your Windows or Mac computer.

1. Make sure the CD/DVD tray is not inserted for printing. Make sure there are no errors on the LCD screen, the CD/DVD tray is not inserted for printing, and the output tray is extended.
2. Load a few sheets of plain paper in the product.
3. Do one of the following:
  - **Windows:** Access the Windows Desktop and right-click the product icon in the Windows taskbar.
  - **OS X:** In the Apple menu or the Dock, select **System Preferences**. Select **Print & Fax**, **Print & Scan**, or **Printers & Scanners**, select your product, and select **Options & Supplies**. Select **Utility** and select **Open Printer Utility**.

4. Select **Print Head Alignment**.
5. Click **Next**, then click **Print** to print an alignment sheet.

**Note:** Do not cancel printing while you are printing a head alignment pattern.

You see a window like this:

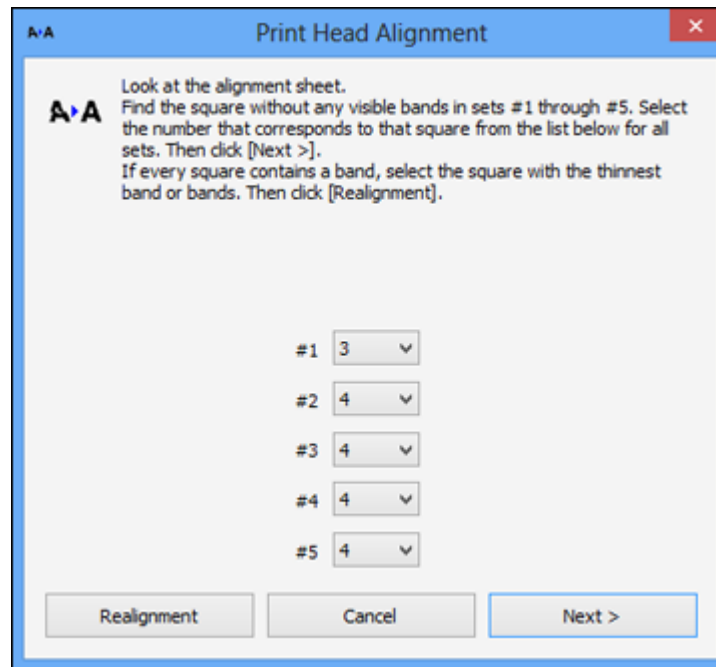

6. Check the printed pattern and follow the instructions on the screen to choose the number of the best printed pattern for each set.
  - After choosing a pattern number, click **Next**.
  - If no patterns are aligned in one or more of the sets, choose the closest one in each set and click **Realignment**. Then print another alignment sheet and check it.

**Note:** Click **Skip** (where available) if you want to skip a particular alignment sheet.

7. When you are done, click **Finish**.

**Parent topic:** [Print Head Alignment](#)

**Related tasks**

[Loading Paper in Cassette 2 \(Lower Cassette\)](#)

## Cleaning the Paper Path

If you see ink on the back of a printout, you can clean the paper path to remove any excess ink.

**Caution:** Do not use tissues to clean the rollers inside the product; lint from tissue may clog the print head nozzles.

1. Load a few sheets of plain paper in the product.
2. Use the product control panel to make a copy, but without placing a document on the scanner glass.

**Note:** Make sure there is no dust or stains on the scanner glass or document cover.

3. Check the back of the ejected paper to see if it is clean.
4. Repeat as necessary until the paper comes out clean.

**Parent topic:** [Adjusting Print Quality](#)

**Related tasks**

[Loading Paper in Cassette 2 \(Lower Cassette\)](#)

---

# Cleaning and Transporting Your Product

See these sections if you need to clean or transport your product.

[Cleaning Your Product](#)

[Transporting Your Product](#)

## Cleaning Your Product

To keep your product working at its best, you should clean it several times a year.

Close the output tray and front cover when you are not using the product to protect it from dust.

**Caution:** Do not use a hard brush, alcohol, or paint thinner to clean the product or you may damage it. Do not use oil or other lubricants inside the product or let water get inside it.

1. Turn off the product.
2. Unplug the power cable.
3. Disconnect any connected cables.
4. Remove all the paper.
5. Clean the scanner glass with a soft, lint-free cloth (microfiber is recommended), moistened with a little glass cleaner.

**Caution:** Do not spray glass cleaner directly on the glass and do not press the glass surface with any force.

6. Clean the outer case and control panel with a soft, dry cloth. Do not use liquid or chemical cleansers.

**Parent topic:** [Cleaning and Transporting Your Product](#)

## Transporting Your Product

If you need to store your product or transport it a long distance, prepare it for transportation as described here.

**Caution:** During transportation and storage, follow these guidelines:

- Avoid tilting the product, placing it vertically, or turning it upside down; otherwise ink may leak.

- Leave the ink cartridges installed. Removing the cartridges can dry out the print head and may prevent the product from printing.
- Do not carry the product by its control panel; this may damage the product.

**Note:** Before storing your product for a long period, replace low, expended, or expired ink to help prevent the print head from drying out. Store your product in a cool, dry place.

1. Turn off the product.
2. Lift up the scanner unit and check to see if the print head is in the far right position (the home position). If not, turn on the product, wait for the print head to move, then turn the product off again.
3. Secure the ink cartridge holder to the case with tape.

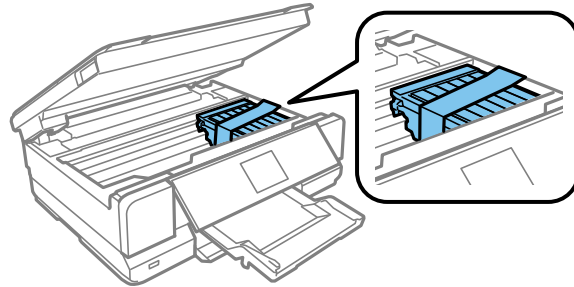

**Caution:** Do not place tape on the white flat cable inside the product; otherwise, you may damage your product.

4. Lower the scanner unit.
5. Remove all the paper from the product.
6. Remove any memory cards inserted in the product.
7. Unplug the power cable.
8. Disconnect any connected cables.

9. Close the rear paper feed slot cover and the output tray. Then lower the control panel.

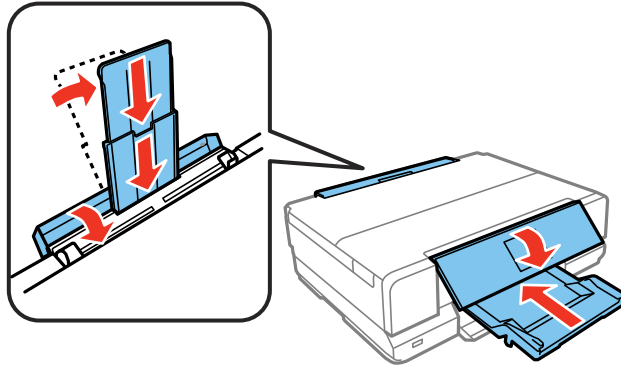

10. Place the product in its original packing materials, if possible, or use equivalent materials with cushioning around the product.

Keep the product level during transportation. Be sure to remove the tape from the ink cartridge holder before turning on your product. If print quality has declined when you print again, clean and align the print head.

**Parent topic:** [Cleaning and Transporting Your Product](#)

**Related concepts**

[Print Head Cleaning](#)

[Print Head Alignment](#)

---

# Solving Problems

Check these sections for solutions to problems you may have using your product.

[Checking for Software Updates](#)

[Product Status Messages](#)

[Running a Product Check](#)

[Resetting Control Panel Defaults](#)

[Solving Setup Problems](#)

[Solving Network Problems](#)

[Solving Copying Problems](#)

[Solving Paper Problems](#)

[Solving Problems Printing from a Computer](#)

[Solving Page Layout and Content Problems](#)

[Solving Print Quality Problems](#)

[Solving Scanning Problems](#)

[Solving Scanned Image Quality Problems](#)

[Solving Memory Card Problems](#)

[Uninstall Your Product Software](#)

[Where to Get Help](#)

## Checking for Software Updates

Periodically, it's a good idea to check Epson's support website for free updates to your product software. You can select **Download the Latest Software** from the Home screen of this manual or visit Epson's driver download site ([U.S. downloads](#) or [Canadian downloads](#)).

- **Windows:** Your printer software automatically checks for updates. You can also manually update the software by selecting **Software Update** here:
  - Accessing the Windows Desktop and right-clicking the product icon in the Windows taskbar
  - On the **Maintenance** tab in the printer settings window

You can also update the software by selecting **EPSON Software Updater** in the **EPSON** or **EPSON Software** program group, accessible by the **Start** button, or on the **Start** or **Apps** screens, depending on your version of Windows.

- **OS X:** You can manually update the software by opening the **Applications > Epson Software** folder and selecting **EPSON Software Updater**.

Parent topic: [Solving Problems](#)

Related tasks

[Changing Automatic Update Options](#)

## Product Status Messages

You can often diagnose problems with your product by checking the messages on its LCD screen. You can also see help information and how-to instructions on the screen. Press the  home button, if necessary, press the left or right arrow button, and then select **Help**.

LCD screen message	Condition/solution
Paper jam	Paper is jammed in the product. Follow the instructions on the LCD screen to remove the jammed paper from the indicated area.
Paper out	No paper is loaded. Load paper in the product.
Photos not recognized. Place the photos correctly on the scanner glass.	There is a problem with originals placed on the product. Check to make sure they are placed correctly and repeat the operation.
Printer error. Turn the power off and on again. For details, see your documentation.	A fatal error has occurred. Turn the product off and then back on again. If the error continues, check for a paper jam. If there is no paper jam, contact Epson for support.
Communication error. Check if a computer is connected.	Make sure the computer is connected to your product and your scanning software is installed correctly.
A printer's ink pad is nearing the end of its service life. Contact Epson Support.	The ink pads are near the end of their service life and the message will be displayed until the ink pad is replaced. Contact Epson for support. (To resume printing, press the  <b>Start</b> button.)
A printer's ink pad is at the end of its service life. Contact Epson Support.	The ink pad is at the end of its service life. Turn off the product and contact Epson for support.
Memory card or external device not recognized.	Make sure the memory card or external device is inserted correctly and meets the specifications for your product.

LCD screen message	Condition/solution
Combination of IP address and subnet mask is invalid. See your documentation.	There is a problem with the network connection to your product.
Recovery mode	An error has occurred during firmware updating. Connect your product using a USB cable and try downloading the Firmware Update from Epson's support website. If you still need help, contact Epson for support.

**Note:** The ink pads in the printer collect, distribute, and contain the ink that is not used on printed pages. During the life of your product it may reach a condition where either satisfactory print quality cannot be maintained or the ink pads have reached the end of their usable life. The Epson Status Monitor, your LCD screen, or lights on the control panel will advise you when these parts need replacing. If this happens during the standard warranty of the product, the exchange of the product or replacement of the pads is covered under the standard warranty. If the product is out of warranty, the pads can be replaced by any Epson authorized service provider. The waste ink pads are not a user-replaceable part.

**Parent topic:** [Solving Problems](#)

**Related references**

[Paper Jam Problems Inside the Product](#)

[Paper Jam Problems in the Paper Cassette](#)

[Paper Jam Problems in the Auto Duplexer or Rear Cover](#)

[Where to Get Help](#)

**Related tasks**

[Placing Originals on the Scanner Glass](#)

**Related topics**

[Solving Network Problems](#)

## Running a Product Check

Running a product check helps you determine if your product is operating properly.

1. Disconnect any interface cables connected to your product.
2. Load plain paper in the product.
3. Press the  home button, if necessary.

4. Select **Setup**.
5. Select **Maintenance**.



6. Select **Nozzle Check**.

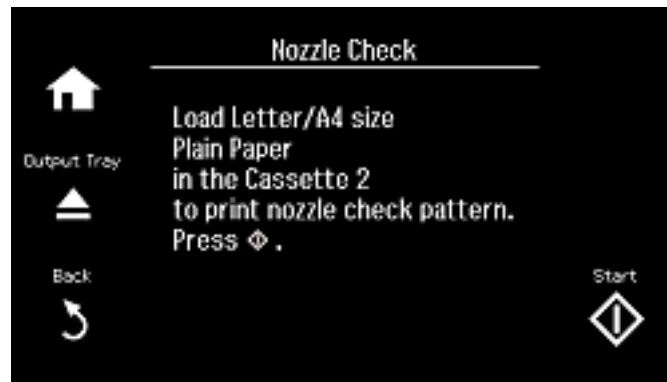

7. Press the ◊ **Start** button.  
The nozzle check pattern is printed.
8. Do one of the following, depending on the results of the product check:
  - If the page prints and the nozzle check pattern is complete, the product is operating properly. Any operation problem you may have could be caused by your computer, cable, software, or selected

settings. Check the other solutions in this book or try uninstalling and reinstalling your printer software.

- If the page prints but the nozzle check pattern has gaps, clean or align the print head.
- If the page does not print, the product may have a problem. Check the other solutions in this manual. If they do not work, contact Epson.

**Parent topic:** [Solving Problems](#)

**Related concepts**

[Print Head Cleaning](#)

[Print Head Alignment](#)

[Uninstall Your Product Software](#)

**Related references**

[Where to Get Help](#)

## Resetting Control Panel Defaults

If you have a problem with settings on the product control panel, you can reset them to their factory defaults. You can choose which settings to reset or reset them all.

1. Press the  home button, if necessary.
2. Select **Setup**.
3. Scroll down and select **Restore Default Settings**.

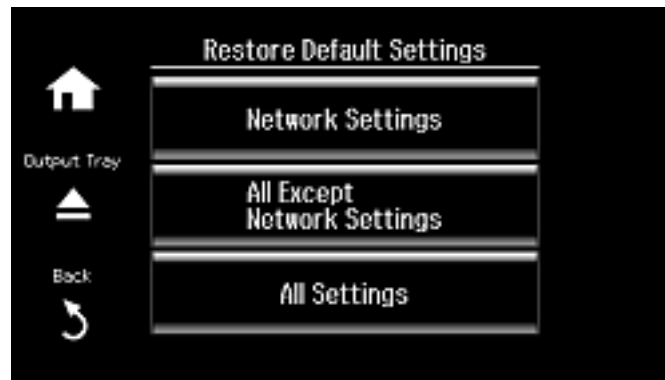

4. Select one of these options:
  - **Wi-Fi/Network Settings:** Resets all network settings.
  - **All except Wi-Fi/Network Settings:** Resets all control panel settings, except for network settings.
  - **All Settings:** Resets all control panel settings.You see a confirmation screen.
5. Select **Yes** to reset the selected settings. (Select **No** if you want to cancel the operation.)

**Parent topic:** [Solving Problems](#)

## Solving Setup Problems

Check these sections if you have problems while setting up your product.

[Noise After Ink Installation](#)

[Software Installation Problems](#)

[Control Panel Setup Problems](#)

**Parent topic:** [Solving Problems](#)

## Noise After Ink Installation

If you hear noises from your product after installing ink, check the following:

- The first time you install ink cartridges, the product must charge its print head. Wait until charging finishes before you turn off the product, or it may charge improperly and use excess ink the next time you turn it on. Your product is finished charging the print head when the ⏻ power light stops flashing.
- If the product's print head stops moving or making noise, and the charging process has not finished after approximately 5 minutes, turn off your product. Turn it back on and check to see if charging is still in progress. If it is still in progress, contact Epson for help.

**Parent topic:** [Solving Setup Problems](#)

**Related references**

[Where to Get Help](#)

## Software Installation Problems

If you have problems while installing your product software, try these solutions:

- Make sure your product is turned on and any necessary cables are securely connected at both ends. If you still have problems installing software, disconnect the cable and carefully follow the instructions on the *Start Here* sheet. Also make sure your system meets the requirements for your operating system.

- Close any other programs, including screen savers and virus protection software, and install your product software again.
- In Windows, make sure your product is selected as the default printer and the correct port is shown in the printer properties.
- If you see any error message or your software does not install correctly in Windows, you may not have software installation privileges. Contact your System Administrator.

**Parent topic:** [Solving Setup Problems](#)

**Related concepts**

[Uninstall Your Product Software](#)

**Related references**

[Windows System Requirements](#)

[OS X System Requirements](#)

## Control Panel Setup Problems

If you have problems setting up the control panel, try these solutions:

- To view LCD screen text in a different language, select a different language setting for the panel.
- To adjust the position of the control panel, carefully raise or lower it.

**Parent topic:** [Solving Setup Problems](#)

**Related tasks**

[Adjusting Control Panel Position](#)

[Changing LCD Screen Language](#)

## Solving Network Problems

Check these solutions if you have problems setting up or using your product on a network.

**Note:** Breakdown or repair of this product may cause loss of network data and settings. Epson is not responsible for backing up or recovering data and settings during or after the warranty period. We recommend that you make your own backup or print out your network data and settings.

[Product Cannot Connect to a Wireless Router or Access Point](#)

[Network Software Cannot Find Product on a Network](#)

[Product Does Not Appear in OS X Printer Window](#)

[Cannot Print Over a Network](#)

[Cannot Scan Over a Network](#)

**Parent topic:** [Solving Problems](#)

**Related tasks**

[Printing a Network Status Sheet](#)

## Product Cannot Connect to a Wireless Router or Access Point

If your product has trouble finding or connecting to a wireless router or access point, try these solutions:

- If you are connecting the product via Wi-Fi Protected Setup (WPS) and the Wi-Fi icon on your product's LCD screen is not lit or does not appear, make sure you select one of the WPS options from the product control panel within 2 minutes of pressing the WPS button on your router.
- Make sure to place your product within contact range of your 2.4 GHz router or access point. Avoid placing your product near a microwave oven, 2.4 GHz cordless phone, or large metal object, such as a filing cabinet.

**Note:** If you are using a 5 GHz wireless router, set the router to operate in dual band (2.4 GHz and 5 GHz) mode. See your router documentation for instructions.

- Verify that your router or access point is operating correctly by connecting to it from your computer or another device.
- You may need to disable the firewall and any anti-virus software on your wireless router or access point.
- Check to see if access restrictions, such as MAC address filtering, are set on the router or access point. If access restrictions are set, add your product's MAC address to your router's address list. To obtain your product's MAC address, print a network status sheet. Then follow the instructions in your router or access point documentation to add the address to the list.
- If your router or access point does not broadcast its network name (SSID), follow the instructions that came with your product to enter your wireless network name manually.
- If your router or access point has security enabled, determine the kind of security it is using and any required password or passphrase for connection. Then make sure to enter the exact WEP key or WPA passphrase correctly.
- Check if your computer is restricting the available wireless channels. If so, verify that your wireless access point is using one of the usable channels and change to a usable channel, if necessary.
- If you are using a Wi-Fi Direct connection that suddenly disconnects, the Wi-Fi direct password on your device may have been changed. If necessary, delete the existing **DIRECT-xxxxxxx** connection settings from your device and enter a new password. See your device documentation for instructions.

- If you connected your product to a Windows computer using Wi-Fi Direct and it automatically selected Access Point Mode, you may have trouble accessing a low-priority Internet connection. Check the network connection or adapter settings in the Windows Control Panel and set the **Internet metric** setting to **100** for your version of the Internet Protocol.

**Parent topic:** [Solving Network Problems](#)

**Related tasks**

[Printing a Network Status Sheet](#)

[Enabling Wi-Fi Direct Mode](#)

## Network Software Cannot Find Product on a Network

If EpsonNet Setup cannot find your product on a network, try these solutions:

- Make sure your product is turned on and connected to your network. Verify connection using your product control panel.
- Check if your network name (SSID) contains non-ASCII characters. Your product cannot display non-ASCII characters.
- Make sure your product is not connected to a guest network.
- If necessary, reinstall your product software and try running EpsonNet Setup again:
  1. Reset your product's network settings to their factory defaults.
  2. Windows only: uninstall your product software.
  3. Initialize your router following the instructions in your router documentation.

**Note:** If you are reading these instructions online, you will lose your Internet connection when you initialize your router, so note the next step before initializing it.

4. Download your product software from the Epson website using the instructions on the *Start Here* sheet.
- If you have replaced your router, reinstall your product software to connect to the new router.

**Note:** If you are using a 5 GHz wireless router, set the router to operate in dual band (2.4 GHz and 5 GHz) mode. See your router documentation for instructions.

**Parent topic:** [Solving Network Problems](#)

**Related concepts**

[Uninstall Your Product Software](#)

## Related tasks

[Resetting Control Panel Defaults](#)

## Product Does Not Appear in OS X Printer Window

If your product does not appear in the OS X printer window, try these solutions:

- Turn your product off, wait 30 seconds, then turn it back on again.
- If you are connecting the product via Wi-Fi Protected Setup (WPS) and the Wi-Fi icon on your product's LCD screen is not lit, make sure you select one of the WPS options from the product control panel within 2 minutes of pressing the WPS button on your router.
- If you are connecting the product wirelessly via EpsonNet Setup and the Wi-Fi icon does not appear lit on your LCD screen, make sure your product software was installed correctly. If necessary, reinstall your software.

**Note:** If you are using a 5 GHz wireless router, set the router to operate in dual band (2.4 GHz and 5 GHz) mode. See your router documentation for instructions.

**Parent topic:** [Solving Network Problems](#)

## Related concepts

[Uninstall Your Product Software](#)

## Cannot Print Over a Network

If you cannot print over a network, try these solutions:

- Make sure that your product is turned on.
- Make sure you install your product's network software as described in your product documentation.
- Print a network status sheet and verify that the network settings are correct. If the network status is **Disconnected**, check any cable connections and turn your product off and then on again.
- If you are using TCP/IP, make sure the product's IP address is set correctly for your network. If your network does not assign IP addresses using DHCP, set the IP address manually.
- Make sure your computer and product are both using the same wireless network.
- If network printing is slow, print a network status sheet and check the signal strength. If it is poor, place your product closer to your router or access point. Avoid placing your product near a microwave oven, 2.4 GHz cordless phone, or large metal object, such as a filing cabinet.

**Note:** If you are using a 5 GHz wireless router, set the router to operate in dual band (2.4 GHz and 5 GHz) mode. See your router documentation for instructions.

- Check to see if your wireless router or access point has an enabled Privacy Separator function that is preventing printing from a device over the network. See your router or access point documentation for instructions on disabling the Privacy Separator function.
- If you are connecting the product via Wi-Fi Protected Setup (WPS) and the Wi-Fi icon on your product's LCD is not lit, make sure you select one of the WPS options from the product control panel within 2 minutes of pressing the WPS button on your router.
- Check your wired LAN router or access point to see if the LED for the port to which your product is connected is on or flashing. If the link LED is off, try the following:
  - Make sure the Ethernet cable is securely connected to your product and to your router, access point, switch, or hub.
  - Try connecting your product to a different port or a different router, access point, switch, or hub.
  - Try connecting with a different Ethernet cable.
  - Try printing to your product from another computer on the network.

**Note:** If you are using a 5 GHz wireless router, set the router to operate in dual band (2.4 GHz and 5 GHz) mode. See your router documentation for instructions.

- If you are connecting the product via EpsonNet Setup and the Wi-Fi icon does not appear lit on the LCD, make sure your product software was installed correctly. If necessary, reinstall your software.

**Parent topic:** [Solving Network Problems](#)

**Related concepts**

[Uninstall Your Product Software](#)

**Related tasks**

[Printing a Network Status Sheet](#)

## Cannot Scan Over a Network

If you cannot start Epson Scan for scanning over a network, try these solutions:

- If you cannot scan from your product control panel, make sure you restarted your computer after installing the product software. Make sure the Event Manager program is not being blocked by your firewall or security software.

**Note:** If you are using a 5 GHz wireless router, set the router to operate in dual band (2.4 GHz and 5 GHz) mode. See your router documentation for instructions.

- If you are scanning a large original at a high resolution, a network communication error may occur. Try scanning again at a lower resolution.
- If network communication was interrupted while starting Epson Scan, exit Epson Scan, wait a few seconds, and restart it. If Epson Scan cannot restart, turn off your product, turn it back on, and try restarting Epson Scan again.
- Check the connection setting and test the connection using Epson Scan Settings:

**Windows 8.x:** Navigate to the **Apps** screen and select **EPSON Scan Settings**. Make sure the **Connection** setting is set to **Network**, then click the **Test** button.

**Windows (other versions):** Click  or **Start > All Programs** or **Programs > EPSON > EPSON Scan > EPSON Scan Settings**. Make sure the **Connection** setting is set to **Network**, then click the **Test** button.

**OS X:** Open the **Applications** folder, click **Epson Software**, and click **EPSON Scan Settings**. Make sure the **Connection** setting is set to **Network**, then click the **Test** button.

- Make sure the option selected as the **Timeout Setting** in the Epson Scan Settings program is long enough to complete scanning over a network.
- You may need to disable the firewall and any anti-virus software on your wireless router or access point.

**Note:** With OS X, in addition to scanning with Image Capture, you can download and install Epson Scan scanning software. Epson Scan provides additional image adjustment and photo correction features for enhancing scanned images, and provides an interface for TWAIN-compliant OCR scanning software. To download Epson Scan, visit Epson's driver download site ([U.S. downloads](#) or [Canadian downloads](#)).

**Parent topic:** [Solving Network Problems](#)

## Solving Copying Problems

Check these solutions if you have problems copying with your product.

[Product Makes Noise, But Nothing Copies](#)

[Product Makes Noise When It Sits for a While](#)

**Parent topic:** [Solving Problems](#)

## Product Makes Noise, But Nothing Copies

If your product makes a noise, but nothing copies, try these solutions:

- Run a nozzle check to see if any of the print head nozzles are clogged. Then clean the print head, if necessary.
- If the nozzle check page does not print, but the product's power is on, make sure your product software is installed correctly.
- Make sure your product is level (not tilted).

**Parent topic:** [Solving Copying Problems](#)

## Product Makes Noise When It Sits for a While

Your product is performing routine maintenance. This is normal.

**Parent topic:** [Solving Copying Problems](#)

## Solving Paper Problems

Check these sections if you have problems using paper with your product.

[Paper Feeding Problems](#)

[Paper Jam Problems Inside the Product](#)

[Paper Jam Problems in the Paper Cassette](#)

[Paper Jam Problems in the Auto Duplexer or Rear Cover](#)

[Paper Ejection Problems](#)

**Parent topic:** [Solving Problems](#)

## Paper Feeding Problems

If you have problems feeding paper, try these solutions:

- If paper does not feed for printing, remove it from the rear feed slot or cassette. Reload it, then adjust the edge guides. Make sure the paper stack is not above the tab on the edge guides inside the cassette. Make sure to load only one sheet at a time in the rear feed slot.
- Be sure to insert the paper cassette all the way into your product.
- If multiple pages feed at once, remove the paper, fan the edges to separate the sheets, and reload it.
- Do not load more than the recommended number of sheets.
- Make sure your paper meets the specifications for your product.

- If paper jams when you print on both sides of the paper, try loading fewer sheets.
- For best results, follow these guidelines:
  - Use new, smooth, high-quality paper that is not curled, creased, old, too thin, or too thick.
  - Load paper in the cassette printable side down.
  - Follow any special loading instructions that came with the paper.

**Parent topic:** [Solving Paper Problems](#)

**Related references**

[Paper Loading Capacity](#)

[Paper Jam Problems Inside the Product](#)

[Paper Jam Problems in the Paper Cassette](#)

[Paper Jam Problems in the Auto Duplexer or Rear Cover](#)

## Paper Jam Problems Inside the Product

If you see a message that paper has jammed inside the product, follow the steps here or on the LCD screen to clear the jam.

1. Cancel the print job, if necessary.
2. Remove any jammed paper from the rear paper feed slot.

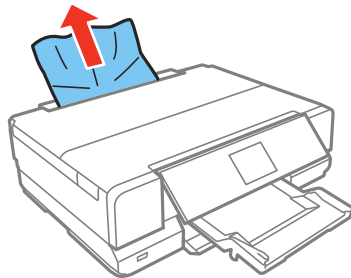

3. Lift the scanner unit and remove any jammed paper inside.

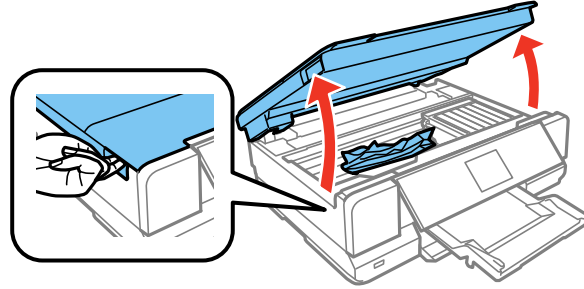

**Caution:** Do not touch the flat white cable inside the printer.

4. Close the scanner unit.

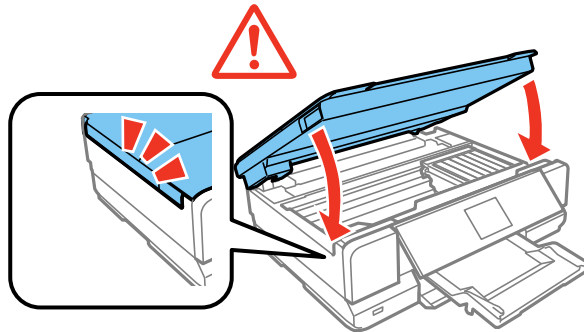

5. Follow the prompts on the LCD screen to clear any error messages. If you still see a paper jam message, check the other paper jam solutions.

**Parent topic:** [Solving Paper Problems](#)

**Related references**

[Paper Jam Problems in the Paper Cassette](#)

[Paper Jam Problems in the Auto Duplexer or Rear Cover](#)

## Paper Jam Problems in the Paper Cassette

If you see a message that paper has jammed in the paper cassette, follow the steps here or on the LCD screen to clear the jam.

1. Cancel the print job, if necessary.
2. Pull out both paper cassettes, then carefully remove any jammed paper.

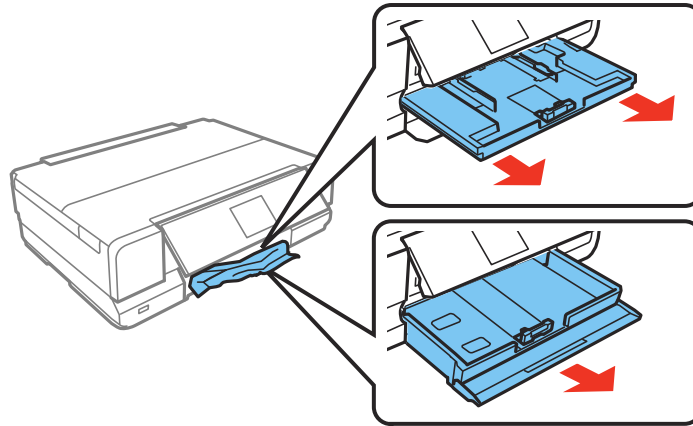

3. Make sure the paper you loaded is under the edge guides.
4. Keep the cassette flat as you insert it. If inserting Cassette 1 (upper cassette), insert it until the arrows on the right side line up.
5. Follow the prompts on the LCD screen to clear any error messages. If you still see a paper jam message, check the other paper jam solutions.

**Parent topic:** [Solving Paper Problems](#)

### Related references

[Paper Jam Problems Inside the Product](#)

[Paper Jam Problems in the Auto Duplexer or Rear Cover](#)

## Paper Jam Problems in the Auto Duplexer or Rear Cover

If you see a message that paper has jammed in the auto duplexer or rear cover, follow the steps here or on the LCD screen to clear the jam.

1. Cancel the print job, if necessary.

2. Press the buttons to release the auto duplexer and remove it from your product. Carefully remove any jammed paper from inside the product.

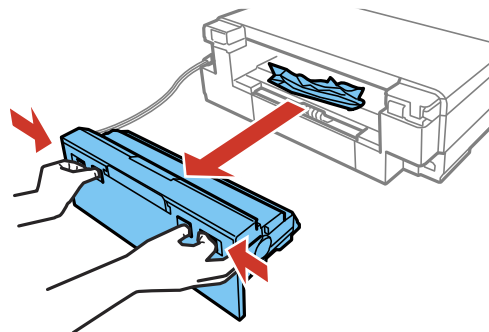

3. Remove any jammed paper from the duplexer.

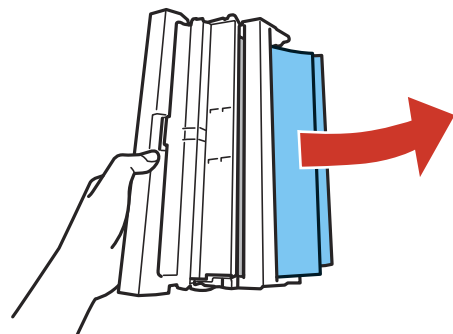

4. Open the duplexer and remove any jammed paper from inside it.

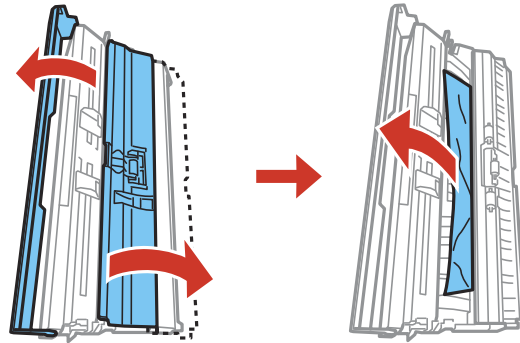

5. Reattach the duplexer.

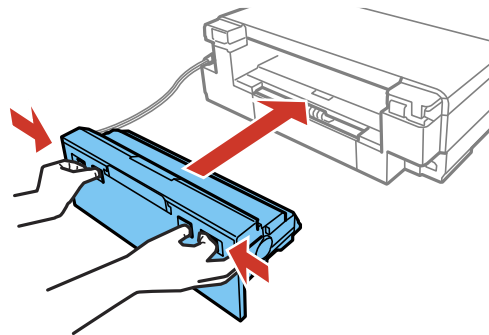

6. Follow the prompts on the LCD screen to clear any error messages. If you still see a paper jam message, check the other paper jam solutions.

**Parent topic:** [Solving Paper Problems](#)

**Related references**

[Paper Jam Problems Inside the Product](#)

[Paper Jam Problems in the Paper Cassette](#)

## Paper Ejection Problems

If you have problems with paper ejecting properly, try these solutions:

- If paper does not eject fully, you may have set the wrong paper size. Cancel printing to eject the paper. Select the correct paper size when you reprint.
- If paper is wrinkled when it ejects, it may be damp or too thin. Load new paper and be sure to select the correct paper type setting when you reprint.

**Parent topic:** [Solving Paper Problems](#)

### Related references

[Paper Jam Problems Inside the Product](#)

[Paper Jam Problems in the Paper Cassette](#)

[Paper Jam Problems in the Auto Duplexer or Rear Cover](#)

[Paper or Media Type Settings - Control Panel](#)

[Paper or Media Type Settings - Printer Software](#)

## Solving Problems Printing from a Computer

Check these sections if you have problems while printing from your computer.

**Note:** When printing using AirPrint, the available print settings are different from those covered in this manual. See the Apple website for details.

[Nothing Prints](#)

[Product Icon Does Not Appear in Windows Taskbar](#)

[Error After Cartridge Replacement](#)



[Printing is Slow](#)

**Parent topic:** [Solving Problems](#)

## Nothing Prints

If you have sent a print job and nothing prints, try these solutions:

- Make sure your product is turned on.
- Make sure any interface cables are connected securely at both ends.
- If you connected your product to a USB hub, make sure it is a first-tier hub. If it still does not print, connect your product directly to your computer instead of the hub.

- Run a product check to see if a test page prints. If the test page prints, check to see if your product software is installed correctly.
- In Windows, make sure your product is selected as the default printer.
- In Windows, clear any stalled print jobs from the Windows Spooler:
  - **Windows 8.x:** Navigate to the **Apps** screen and select **Control Panel > Hardware and Sound > Devices and Printers**. Right-click your product name, select **See what's printing**, and select your product name again if necessary. Right-click the stalled print job, click **Cancel**, and click **Yes**.
  - **Windows 7:** Click  and select **Devices and Printers**. Right-click your product name, select **See what's printing**, and select your product name again, if necessary. Right-click the stalled print job, click **Cancel**, and click **Yes**.
  - **Windows Vista:** Click  and select **Control Panel**. Click **Printer** under **Hardware and Sound**, right-click your product name, and select **Open**. Right click the stalled print job, click **Cancel**, and click **Yes**.
  - **Windows XP:** Click **Start** and select **Printers and Faxes**. (Or open the **Control Panel**, select **Printers and Other Hardware**, if necessary, and select **Printers and Faxes**.) Right-click your product name, select **Open**, right-click the stalled print job, click **Cancel**, and click **Yes**.



Parent topic: [Solving Problems Printing from a Computer](#)

#### Related tasks

[Running a Product Check](#)

## Product Icon Does Not Appear in Windows Taskbar

If you do not see your product icon in the Windows taskbar, first try restarting your computer. If that does not work, try this solution:

1. Do one of the following:
  - **Windows 8.x:** Navigate to the **Apps** screen and select **Control Panel > Hardware and Sound > Devices and Printers**.
  - **Windows 7:** Click  and select **Devices and Printers**.
  - **Windows Vista:** Click , select **Control Panel**, and click **Printer** under **Hardware and Sound**.
  - **Windows XP:** Click **Start** and select **Printers and Faxes**. (Or open the **Control Panel**, select **Printers and Other Hardware**, if necessary, and **Printers and Faxes**.)
2. Right-click your product name, select **Printing Preferences**, and select your product name again if necessary.

3. Click the **Maintenance** tab.
4. Click the **Extended Settings** button.
5. Click the **Monitoring Preferences** button.
6. Click the checkbox for the option that adds the shortcut icon to the taskbar.
7. Click **OK** to close the open program windows.

**Parent topic:** [Solving Problems Printing from a Computer](#)

## Error After Cartridge Replacement

If you see an error light or error message after you replace an ink cartridge, follow these steps:

1. Make sure the print head is in the ink cartridge replacement position.

**Note:** If the print head is not in the ink cartridge replacement position, follow the instructions on replacing an ink cartridge in this manual to move it.

2. Remove and reinsert the replaced ink cartridge, making sure to push it all the way into its slot.
3. Complete the ink cartridge installation steps.

**Parent topic:** [Solving Problems Printing from a Computer](#)

### Related topics

[Replacing Ink Cartridges](#)

## Printing is Slow

If printing becomes slow, try these solutions:

- Make sure your system meets the requirements for your operating system. If you are printing a high-resolution image, you may need more than the minimum requirements. If necessary, increase your system's memory.
- If you are using Windows 7, close the **Devices and Printers** window before you print.
- Make sure **Quiet Mode** is turned off.
- Clear space on your hard drive or run a defragmentation utility to free up existing space.
- Close any programs you are not using when you print.
- If your product is connected to a USB hub, connect it directly to your computer instead.

- If printing becomes slower after printing continuously for a long time, the product may have automatically slowed down to protect the print mechanism from overheating or becoming damaged. Let the product rest with the power on for 30 minutes, then try printing again.

For the fastest printing, select the following settings in your product software:

- Make sure the paper type setting matches the type of paper you loaded.
- Turn on any high speed settings in your product software.
- Select a lower print quality setting.
- Make sure the ink drying time has not been increased for double-sided printing.
- **Windows:** Click the **Maintenance** or **Utility** tab, select **Extended Settings** or **Speed and Progress**, and select the following settings:
  - **High Speed Copies**
  - **Always Spool RAW Datatype**
  - **Page Rendering Mode**
  - **Print as Bitmap**

**Parent topic:** [Solving Problems Printing from a Computer](#)

#### **Related references**

[Paper or Media Type Settings - Control Panel](#)

[Paper or Media Type Settings - Printer Software](#)

[Windows System Requirements](#)

[OS X System Requirements](#)

#### **Related tasks**

[Selecting Basic Print Settings - OS X](#)

[Selecting Basic Print Settings - Windows](#)

## **Solving Page Layout and Content Problems**

Check these sections if you have problems with the layout or content of your printed pages.

**Note:** When printing using AirPrint, the available print settings are different from those covered in this manual. See the Apple website for details.

[Inverted Image](#)

[Too Many Copies Print](#)

[Blank Pages Print](#)  
[Incorrect Margins on Printout](#)  
[Border Appears on Borderless Prints](#)  
[Incorrect Characters Print](#)  
[Incorrect Image Size or Position](#)  
[Slanted Printout](#)

**Parent topic:** [Solving Problems](#)

## Inverted Image

If your printed image is inverted unexpectedly, try these solutions:

- Turn off any mirror or inversion settings in your printing application.
- Turn off the **Mirror Image**, **Flip horizontally**, or **Reverse page orientation** settings in your printer software. (This option has different names, depending on your operating system version.)

**Note:** Leave these options turned on when you print on Epson Iron-on Cool Peel Transfer paper, if available for your product.

**Parent topic:** [Solving Page Layout and Content Problems](#)

### Related tasks

[Selecting Additional Layout and Print Options - Windows](#)  
[Selecting Print Layout Options - OS X](#)

## Too Many Copies Print

Make sure that the **Copies** setting in your printing program or printer software is not set for multiple copies.

**Parent topic:** [Solving Page Layout and Content Problems](#)

## Blank Pages Print

If blank pages print unexpectedly, try these solutions:

- Make sure you selected the correct paper size settings in your printing program and printer software.
- If a blank page exists in a document you are printing and you want to skip printing it, select the **Skip Blank Page** setting in your printer software.

- Run a print head nozzle check to see if any of the nozzles are clogged. Then clean the print head, if necessary.
- Make sure your product is selected as the printer in your printing program.

**Parent topic:** [Solving Page Layout and Content Problems](#)

**Related tasks**

[Selecting Basic Print Settings - Windows](#)

[Selecting Basic Print Settings - OS X](#)

[Selecting Printing Preferences - OS X](#)

## Incorrect Margins on Printout

If your printed page has incorrect margins, try these solutions:

- Make sure you selected the correct paper size settings in your printing program and printer software.
- Make sure you selected the correct margins for your paper size in your printing program.
- Make sure your paper is positioned correctly for feeding into the printer.

You can use the preview option in your printer software to check your margins before you print.

**Parent topic:** [Solving Page Layout and Content Problems](#)

**Related tasks**

[Selecting Basic Print Settings - OS X](#)

[Selecting Additional Layout and Print Options - Windows](#)

**Related topics**

[Loading Paper](#)

## Border Appears on Borderless Prints

If you see a border on borderless prints, try these solutions:

- Make sure you are printing on a compatible borderless paper type and size.

**Note:** For custom paper sizes, make sure you select a supported borderless page width.

- **Windows:** Make sure you selected the **Borderless** setting in your printer software.
- **OS X:** Make sure you selected the **Borderless** checkbox or a paper size with a **Borderless** option in your printer software.

- Adjust the **Expansion** setting to adjust the amount of image expansion on the edges of borderless prints.
- Make sure the image size and the paper size are set correctly; if the image is small, the enlargement may not be enough to cover the paper.

**Parent topic:** [Solving Page Layout and Content Problems](#)

#### **Related references**

[Borderless Paper Type Compatibility](#)

#### **Related tasks**

[Selecting Basic Print Settings - OS X](#)

[Selecting Basic Print Settings - Windows](#)

[Selecting Additional Layout and Print Options - Windows](#)

[Selecting Page Setup Settings - OS X](#)

## **Incorrect Characters Print**

If incorrect characters appear in your prints, try these solutions before reprinting:

- Make sure any cables are securely connected at both ends.
- In Windows, delete all jobs from the Windows Spooler. Click **Print Queue** on the Maintenance tab in the printer settings window, and cancel any stalled print jobs.
- If your product is connected to a USB hub, connect it directly to your computer instead.
- If incorrect characters still appear in your prints, try connecting your product using a different cable.

**Parent topic:** [Solving Page Layout and Content Problems](#)

## **Incorrect Image Size or Position**

If your printed image is the wrong size or in the wrong position, try these solutions:

- Make sure you selected the correct paper size and layout settings in your printing program and printer software.
- Make sure your paper is positioned correctly for feeding into the printer.

You can use the preview option in your printer software to check your margins before you print.

**Parent topic:** [Solving Page Layout and Content Problems](#)

#### **Related tasks**

[Selecting Basic Print Settings - OS X](#)

[Selecting Basic Print Settings - Windows](#)

[Selecting Additional Layout and Print Options - Windows](#)

[Selecting Page Setup Settings - OS X](#)

## Slanted Printout

If your printouts are slanted, try these solutions:

- Slide the edge guides against the edges of the paper.
- Select a higher print quality setting in your printer software.
- Turn off any high speed settings in your product software.
- Align the print head.
- Make sure the product is not printing while tilted or at an angle.

**Parent topic:** [Solving Page Layout and Content Problems](#)

### Related concepts

[Print Head Alignment](#)

### Related tasks

[Selecting Basic Print Settings - OS X](#)

[Selecting Basic Print Settings - Windows](#)

## Solving Print Quality Problems

Check these sections if your printouts have problems with print quality, but your image looks fine on your computer screen.

**Note:** When printing using AirPrint, the available print settings are different from those covered in this manual. See the Apple website for details.

[White or Dark Lines in Printout](#)

[Blurry or Smearred Printout](#)

[Faint Printout or Printout Has Gaps](#)

[Grainy Printout](#)

[Incorrect Colors](#)

**Parent topic:** [Solving Problems](#)

**Related topics**

[Solving Scanned Image Quality Problems](#)

**White or Dark Lines in Printout**

If you notice white or dark lines in your prints (also called banding), try these solutions before you reprint:

- Run a nozzle check to see if any of the print head nozzles are clogged. Then clean the print head, if necessary.
- Make sure the paper type setting matches the type of paper you loaded.
- Make sure you loaded the printable side of the paper correctly for your product.
- Turn off any high speed settings in your product software.
- Align the print head.
- You may need to replace the ink cartridges.

**Parent topic:** [Solving Print Quality Problems](#)

**Related concepts**

[Print Head Cleaning](#)

[Print Head Alignment](#)

[Print Head Nozzle Check](#)

**Related references**

[Paper or Media Type Settings - Control Panel](#)

[Paper or Media Type Settings - Printer Software](#)

[Extended Settings - Windows](#)

**Related tasks**

[Selecting Printing Preferences - OS X](#)

**Related topics**

[Loading Paper](#)

[Replacing Ink Cartridges](#)

**Blurry or Smearred Printout**

If your printouts are blurry or smearred, try these solutions:

- Make sure your paper is not damp, curled, old, or loaded incorrectly in your product.
- Use a support sheet with special paper, or load special paper one sheet at a time.

- Make sure your paper meets the specifications for your product.
- Use Epson papers to ensure proper saturation and absorption of genuine Epson inks.
- Make sure the paper type setting in your product software matches the type of paper you loaded.
- Make sure you loaded the printable side of the paper correctly for your product.
- If you are printing on thick paper or envelopes, turn on the **Thick Paper** setting from the control panel or select **Thick Paper and Envelopes** in the Extended Settings of the printer software. (Turning this setting on will decrease print speed.)
- Remove each sheet from the output tray as it is printed.
- Avoid handling printouts on glossy paper right after printing to allow the ink to set.
- Turn off any high speed settings in your product software.
- If you print on both sides of a sheet of paper, smudges may appear on the reverse side of heavily saturated or dark images. If one side of a sheet will contain a lighter image or text, print that side first. Adjust the **Print Density** and/or **Increase Ink Drying Time** settings.
- Run a nozzle check to see if any of the print head nozzles are clogged. Then clean the print head, if necessary.
- Align the print head.
- Clean the paper path.

**Note:** Your product will not operate properly while tilted at an angle. Place it on a flat, stable surface that extends beyond the base of the product in all directions.

**Parent topic:** [Solving Print Quality Problems](#)

**Related concepts**

[Print Head Cleaning](#)

[Print Head Alignment](#)

**Related references**

[Paper or Media Type Settings - Control Panel](#)

[Paper or Media Type Settings - Printer Software](#)

[Extended Settings - Windows](#)

[Paper Specifications](#)

**Related tasks**

[Selecting Printing Preferences - OS X](#)

[Selecting Double-sided Printing Settings - OS X](#)  
[Selecting Double-sided Printing Settings - Windows](#)  
[Selecting Basic Print Settings - OS X](#)  
[Selecting Basic Print Settings - Windows](#)  
[Cleaning the Paper Path](#)

**Related topics**

[Loading Paper](#)  
[Replacing Ink Cartridges](#)

## **Faint Printout or Printout Has Gaps**

If your printouts are faint or have gaps, try these solutions:

- Run a nozzle check to see if any of the print head nozzles are clogged. Then clean the print head, if necessary.
- The ink cartridges may be old or low on ink, and you may need to replace them.
- Make sure the paper type setting matches the type of paper you loaded.
- Make sure your paper is not damp, curled, old, or loaded incorrectly in your product.
- Align the print head.
- Clean the paper path.

**Parent topic:** [Solving Print Quality Problems](#)

**Related concepts**

[Print Head Nozzle Check](#)  
[Print Head Cleaning](#)  
[Print Head Alignment](#)

**Related references**

[Extended Settings - Windows](#)

**Related tasks**

[Selecting Printing Preferences - OS X](#)  
[Selecting Basic Print Settings - OS X](#)  
[Selecting Basic Print Settings - Windows](#)

## Grainy Printout

If your printouts are grainy, try these solutions:

- Make sure you loaded the printable side of the paper correctly for your product.
- Select a higher print quality setting and turn off any high speed settings in your product software.
- Run a nozzle check to see if any of the print head nozzles are clogged. Then clean the print head, if necessary.
- Align the print head.
- You may need to increase the image resolution or print a smaller size; see your software documentation.

**Note:** Images from the Internet may be low resolution and not result in a high quality printout.

- If you enlarged the image in an image-editing program, you need to increase the resolution setting to retain a high image quality. Increase the resolution by the same amount you increased the image size. For example, if the resolution is 300 dpi (dots per inch) and you will double the image size later, change the resolution setting to 600 dpi.

**Note:** Higher resolution settings result in larger file sizes, which take longer to process and print. Consider the limitations of your computer system when selecting a resolution, and select the lowest possible resolution that produces acceptable quality to keep file sizes manageable.

**Parent topic:** [Solving Print Quality Problems](#)

### Related concepts

[Print Head Nozzle Check](#)

[Print Head Cleaning](#)

[Print Head Alignment](#)

### Related references

[Extended Settings - Windows](#)

### Related tasks

[Selecting Printing Preferences - OS X](#)

[Selecting Basic Print Settings - OS X](#)

[Selecting Basic Print Settings - Windows](#)

## Related topics

[Loading Paper](#)

## Incorrect Colors

If your printouts have incorrect colors, try these solutions:

- Make sure the paper type setting matches the paper you loaded.
- Make sure the **Black/Grayscale** or **Grayscale** setting is not selected in your printer software.
- Run a nozzle check to see if any of the print head nozzles are clogged. Then clean the print head, if necessary.
- The ink cartridges may be old or low on ink, and you may need to replace them.
- After you print, the colors in your printout need time to set as the ink dries. During this time, the colors may look different than you expect. To speed up drying time, do not stack your printouts on top of each other.
- Your printed colors can never exactly match your on-screen colors. However, you can use a color management system to get as close as possible. Try using the color management options in your printer software.
- For best results, use genuine Epson ink and paper.

**Parent topic:** [Solving Print Quality Problems](#)

### Related concepts

[Print Head Cleaning](#)

[Print Head Alignment](#)

### Related references

[Extended Settings - Windows](#)

### Related tasks

[Selecting Basic Print Settings - OS X](#)

[Selecting Basic Print Settings - Windows](#)

[Managing Color - OS X](#)

## Solving Scanning Problems

Check these solutions if you have problems scanning with your product.

[Scanning Software Does Not Operate Correctly](#)

[Cannot Start Epson Scan](#)

**Parent topic:** [Solving Problems](#)

## Scanning Software Does Not Operate Correctly

If your scanning software does not operate correctly, try these solutions:

- Make sure your computer has adequate memory and meets the system requirements for your operating system.
- Make sure your computer is not running in a power-saving mode, such as sleep or standby. If so, wake your system and restart your scanning software.
- If you upgraded your operating system but did not reinstall your scanning software, try reinstalling it.

**Note:** With OS X, in addition to scanning with Image Capture, you can download and install Epson Scan scanning software. Epson Scan provides additional image adjustment and photo correction features for enhancing scanned images, and provides an interface for TWAIN-compliant OCR scanning software. To download Epson Scan, visit Epson's driver download site ([U.S. downloads](#) or [Canadian downloads](#)).

**Parent topic:** [Solving Scanning Problems](#)

### Related concepts

[Uninstall Your Product Software](#)

### Related references

[Windows System Requirements](#)

[OS X System Requirements](#)

### Related tasks

[Scanning with OS X Using Image Capture](#)

## Cannot Start Epson Scan

If you cannot start Epson Scan, try these solutions:

- Make sure your product is turned on and any interface cables are securely connected at both ends.
- Make sure Epson Scan is selected in your scanning program.
- Make sure your computer is not running in a power-saving mode, such as sleep or standby. If so, wake your system and restart Epson Scan.
- Check the connection setting and test the connection using Epson Scan Settings:

**Windows 8.x:** Navigate to the **Apps** screen and select **EPSON Scan Settings**. Make sure the correct **Connection** setting is selected, then click the **Test** button.

**Windows (other versions):** Click  or **Start > All Programs** or **Programs > EPSON > EPSON Scan > EPSON Scan Settings**. Make sure the correct **Connection** setting is selected, then click the **Test** button.

**OS X:** Open the **Applications** folder, click **Epson Software**, and click **EPSON Scan Settings**. Make sure the correct **Connection** setting is selected, then click the **Test** button.

- Make sure you do not have multiple versions of Epson Scan installed. If you do, uninstall both versions and install one version.
- If you upgraded your operating system but did not reinstall Epson Scan, try reinstalling it.

**Note:** With OS X, in addition to scanning with Image Capture, you can download and install Epson Scan scanning software. Epson Scan provides additional image adjustment and photo correction features for enhancing scanned images, and provides an interface for TWAIN-compliant OCR scanning software. To download Epson Scan, visit Epson's driver download site ([U.S. downloads](#) or [Canadian downloads](#)).

**Parent topic:** [Solving Scanning Problems](#)

**Related tasks**

[Scanning with OS X Using Image Capture](#)

**Related topics**

[Starting a Scan](#)

## Solving Scanned Image Quality Problems

Check these sections if a scanned image on your computer screen has a quality problem.

[Image Consists of a Few Dots Only](#)

[Line of Dots Appears in All Scanned Images](#)

[Straight Lines in an Image Appear Crooked](#)

[Image is Distorted or Blurry](#)

[Image Colors are Patchy at the Edges](#)

[Image is Too Dark](#)

[Back of Original Image Appears in Scanned Image](#)

[Ripple Patterns Appear in an Image](#)

[Scanned Image Colors Do Not Match Original Colors](#)

[Scan Area is Not Adjustable in Thumbnail Preview](#)

[Scanned Image Edges are Cropped](#)

**Parent topic:** [Solving Problems](#)

**Related topics**

[Solving Print Quality Problems](#)

## Image Consists of a Few Dots Only

If your scanned image consists only of a few dots, try these solutions:

- Make sure you placed your original for scanning facing the correct way.
- If you are scanning using the Epson Scan **Black & White** setting, adjust the **Threshold** setting and scan again.

**Parent topic:** [Solving Scanned Image Quality Problems](#)

**Related references**

[Available Image Adjustments - Professional Mode](#)

[Available Image Adjustments - Home Mode](#)

[Available Image Adjustments - Office Mode](#)

**Related tasks**

[Placing Originals on the Scanner Glass](#)

## Line of Dots Appears in All Scanned Images

If a line of dots appears in all your scanned images, clean the scanner glass with a soft, dry, lint-free cloth or use a small amount of glass cleaner on the cloth, if necessary. Paper towels are not recommended.

**Caution:** Do not spray glass cleaner directly on the scanner glass.

**Parent topic:** [Solving Scanned Image Quality Problems](#)

**Related tasks**

[Cleaning Your Product](#)

## Straight Lines in an Image Appear Crooked

If straight lines in an original appear crooked in a scanned image, make sure to place your original straight when you scan it.

**Parent topic:** [Solving Scanned Image Quality Problems](#)

**Related tasks**

[Placing Originals on the Scanner Glass](#)

## Image is Distorted or Blurry

If a scanned image appears distorted or blurry, try these solutions:

- Make sure your original is not wrinkled or warped. This may prevent the original from laying flat on the scanner glass.
- Do not move your original or your product during scanning.
- Your product will not operate properly while tilted at an angle. Place your product on a flat, stable surface that extends beyond its base in all directions.
- Adjust these Epson Scan settings (if available) and try scanning again:
  - Select the **Unsharp Mask** setting.
  - Adjust the **Auto Exposure** setting.
  - Increase the **Resolution** setting.

**Parent topic:** [Solving Scanned Image Quality Problems](#)

**Related topics**

[Selecting Epson Scan Settings](#)

## Image Colors are Patchy at the Edges

If you are scanning a thick or warped original, cover its edges with paper to block external light as you scan it.

**Parent topic:** [Solving Scanned Image Quality Problems](#)

## Image is Too Dark

If your scanned image is too dark, try these solutions:

- Adjust these Epson Scan settings (if available) and try scanning again:
  - **Auto Exposure**
  - **Brightness**
  - **Histogram Adjustment**
- Check the brightness and contrast settings of your computer monitor.

**Parent topic:** [Solving Scanned Image Quality Problems](#)

**Related topics**

[Selecting Epson Scan Settings](#)

## Back of Original Image Appears in Scanned Image

If an image from the back of a thin original appears in your scanned image, place a piece of black paper on the back of the original and scan it again.

**Parent topic:** [Solving Scanned Image Quality Problems](#)

## Ripple Patterns Appear in an Image

You may see a ripple pattern (called a moiré) in scanned images of printed documents. This is caused by interference from differing pitches in the scanner's screen and your original's halftone screen. To reduce this effect, adjust these Epson Scan settings (if available) and try scanning again:

- Select the **Descreening** setting.
- Select a lower **Resolution** setting.

**Parent topic:** [Solving Scanned Image Quality Problems](#)

**Related topics**

[Selecting Epson Scan Settings](#)

## Scanned Image Colors Do Not Match Original Colors

Printed colors can never exactly match the colors on your computer monitor because printers and monitors use different color systems: monitors use RGB (red, green, and blue) and printers typically use CMYK (cyan, magenta, yellow, and black).

Check the color matching and color management capabilities of your computer, display adapter, and the software you are using to see if they are affecting the palette of colors you see on your screen.

To adjust the colors in your scanned image, adjust these Epson Scan settings (if available) and try scanning again:

- Change the **Image Type** setting and experiment with different combinations of the next settings.
- Adjust the **Tone Correction** setting.
- Adjust the **Auto Exposure** setting.

**Parent topic:** [Solving Scanned Image Quality Problems](#)

**Related topics**

[Selecting Epson Scan Settings](#)

**Scan Area is Not Adjustable in Thumbnail Preview**

If you cannot adjust the scan area while viewing a Thumbnail preview in Epson Scan, try these solutions:

- Create a scan area by drawing a marquee on your preview image and adjusting it as necessary.
- Switch to Normal preview mode, if available, and preview your image again.

**Parent topic:** [Solving Scanned Image Quality Problems](#)

**Related concepts**

[Image Preview Guidelines](#)

**Related tasks**

[Selecting a Scan Size - Professional Mode](#)

[Selecting a Scan Area - Office Mode](#)

[Selecting a Scan Area - Home Mode](#)

**Scanned Image Edges are Cropped**

If the edges of a scanned image are cropped, make sure your original is placed correctly for scanning. If necessary, move your original away from the edges of the scanner glass slightly.

**Parent topic:** [Solving Scanned Image Quality Problems](#)

**Related tasks**

[Placing Originals on the Scanner Glass](#)

**Solving Memory Card Problems**

Check these solutions if you have problems using memory cards with your product.

[Memory Card Does Not Fit Into a Slot](#)

[Cannot View or Print Photos from a Memory Card](#)

[Cannot Transfer Photos To or From a Memory Card](#)

**Parent topic:** [Solving Problems](#)

**Memory Card Does Not Fit Into a Slot**

If a memory card does not fit properly in a slot, do not force it in. You may need to use an adapter with your memory card.

**Parent topic:** [Solving Memory Card Problems](#)

**Related references**

[Memory Card Types](#)

**Related tasks**

[Inserting a Memory Card](#)

## Cannot View or Print Photos from a Memory Card

If you cannot view or print photos from a memory card inserted in your product, try these solutions:

- Make sure you have inserted only one memory card at a time.
- Make sure your memory card is compatible with the product.
- Make sure the files on your memory card are in the correct format.
- If you have too many photos on your memory card, you may not see all the photos you expect or may be prompted to select a group of photos by date. Reduce the number of photos on your card or select one group of photos at a time. Check the memory card specifications for the maximum number of photos.

**Parent topic:** [Solving Memory Card Problems](#)

**Related references**

[Memory Card Types](#)

[Memory Card File Specifications](#)

**Related tasks**

[Inserting a Memory Card](#)

## Cannot Transfer Photos To or From a Memory Card

If you have problems transferring photos to or from a memory card inserted in your product, try these solutions:

- Make sure you have inserted only one memory card at a time.
- Make sure your memory card is compatible with the product.
- Make sure your product is securely connected to your computer.
- If you are transferring photos to the memory card, check the memory card's write-protect tab to make sure it is set to allow writing to the card. Also make sure the card has enough memory available.
- Make sure that the file sharing setting for your product is set correctly.

**Parent topic:** [Solving Memory Card Problems](#)

**Related references**

[Memory Card File Specifications](#)

[Memory Card Types](#)

**Related topics**

[Transferring Photos on a Memory Card](#)

## Uninstall Your Product Software

If you have a problem that requires you to uninstall and re-install your software, follow the instructions for your operating system.

[Uninstalling Product Software - Windows](#)

[Uninstalling Product Software - OS X](#)

**Parent topic:** [Solving Problems](#)

## Uninstalling Product Software - Windows

You can uninstall and then re-install your product software to solve certain problems.

1. Turn off the product.
2. Disconnect any interface cables.
3. Do one of the following:
  - **Windows 8.x:** Navigate to the **Apps** screen and select **Control Panel > Programs > Programs and Features**. Select the uninstall option for your Epson product, then select **Uninstall/Change**.

**Note:** If you see a **User Account Control** window, click **Yes** or **Continue**.

Select your product again, if necessary, then select **OK**, and click **Yes** to confirm the uninstallation.

- **Windows (other versions):** Click  or **Start**, and select **All Programs** or **Programs**. Select **EPSON**, select your product, then click **EPSON Printer Software Uninstall**.

**Note:** If you see a **User Account Control** window, click **Yes** or **Continue**.

In the next window, select your product and click **OK**. Then follow any on-screen instructions.

4. Do one of the following to uninstall Epson Event Manager, then follow any on-screen instructions:
  - **Windows 8.x:** Select **Epson Event Manager** and click **Uninstall**.
  - **Windows 7/Windows Vista:** Open the Windows **Control Panel** utility. Select **Programs and Features**. (In Classic view, select **Programs** and click **Uninstall a program**.) Select **Epson Event Manager** and click **Uninstall/Change**.
  - **Windows XP:** Open the Windows **Control Panel** utility. Double-click **Add or Remove Programs**. Select **Epson Event Manager** and click **Change/Remove**.
5. Do one of the following to uninstall Epson Scan, then follow any on-screen instructions:
  - **Windows 8.x/Windows 7/Windows Vista:** Select **EPSON Scan** and click **Uninstall/Change**.
  - **Windows XP:** Select **EPSON Scan** and click **Change/Remove**.
6. Restart your computer, then see the *Start Here* sheet to re-install your software.

**Note:** If you find that re-installing your product software does not solve a problem, contact Epson.

**Parent topic:** [Uninstall Your Product Software](#)

## Uninstalling Product Software - OS X

In most cases, you do not need to uninstall your product software before re-installing it. However, you can download the Uninstaller utility from the Epson support website to uninstall your product software as described here.

**Note:** If you find that re-installing your product software does not solve a problem, contact Epson.

1. To download the Uninstaller utility, visit the Epson download site ([U.S. downloads](#) or [Canadian downloads](#)).
2. Follow the instructions on the screen to install the Uninstaller utility.
3. Quit all applications currently running on your Mac.
4. Double-click the **Uninstaller** icon.
5. Select the checkbox for each software program you want to uninstall.
6. Click **Uninstall**.
7. Follow the on-screen instructions to uninstall the software.
8. To reinstall your product software, see the *Start Here* sheet for instructions.

**Note:** If you uninstall the printer driver and your product name remains in the **Print & Fax**, **Print & Scan**, or **Printers & Scanners** window, select your product name and click the – (remove) icon to remove it.

**Parent topic:** [Uninstall Your Product Software](#)

## Where to Get Help

If you need to contact Epson for technical support services, use the following support options.

### Internet Support

Visit Epson's support website at [epson.com/support](http://epson.com/support) (U.S.) or [epson.ca/support](http://epson.ca/support) (Canada) for solutions to common problems. You can download drivers and documentation, get FAQs and troubleshooting advice, or e-mail Epson with your questions.

### Speak to a Support Representative

Before you call Epson for support, please have the following information ready:

- Product name
- Product serial number (located on a label on the product)
- Proof of purchase (such as a store receipt) and date of purchase
- Computer configuration
- Description of the problem

Then call:

- U.S.: (562) 276-4382, 6 AM to 8 PM, Pacific Time, Monday through Friday, and 7 AM to 4 PM, Pacific Time, Saturday
- Canada: (905) 709-3839, 6 AM to 8 PM, Pacific Time, Monday through Friday, and 7 AM to 4 PM, Pacific Time, Saturday

Days and hours of support are subject to change without notice. Toll or long distance charges may apply.

### Purchase Supplies and Accessories

You can purchase genuine Epson ink and paper at [epson.com/ink3](http://epson.com/ink3) (U.S. sales) or [epson.ca](http://epson.ca) (Canadian sales). You can also purchase supplies from an Epson authorized reseller. To find the nearest one, call 800-GO-EPSON (800-463-7766).

**Parent topic:** [Solving Problems](#)

---

# Technical Specifications

These sections list the technical specifications for your product.

**Note:** Epson offers a recycling program for end of life products. Please go to [this site](#) for information on how to return your products for proper disposal.

[Windows System Requirements](#)

[OS X System Requirements](#)

[Scanning Specifications](#)

[Paper Specifications](#)

[Printable Area Specifications](#)

[Ink Cartridge Specifications](#)

[Memory Card Specifications](#)

[External USB Device Specifications](#)

[Dimension Specifications](#)

[Electrical Specifications](#)

[Environmental Specifications](#)

[Interface Specifications](#)

[Network Interface Specifications](#)

[Safety and Approvals Specifications](#)

## Windows System Requirements

To use your product and its software, your computer should use one of these Microsoft operating systems:

- Windows 10
- Windows 8.x
- Windows 7
- Windows Vista
- Windows XP Professional x64 Edition
- Windows XP SP3

**Note:** Visit Epson's support website at [epson.com/support](http://epson.com/support) (U.S.) or [epson.ca/support](http://epson.ca/support) (Canada) for the latest in compatibility and drivers for your product.

**Parent topic:** [Technical Specifications](#)

## OS X System Requirements

To use your product and its software, your Mac should use one of these operating systems:

- OS X 10.10.x
- OS X 10.9.x
- OS X 10.8.x
- OS X 10.7.x
- OS X 10.6.8

**Note:** Visit Epson's support website at [epson.com/support](http://epson.com/support) (U.S.) or [epson.ca/support](http://epson.ca/support) (Canada) for the latest in compatibility and drivers for your product.

**Parent topic:** [Technical Specifications](#)

## Scanning Specifications

<b>Scanner type</b>	Flatbed
<b>Photoelectric device</b>	CIS
<b>Maximum document size</b>	8.5 × 11.7 inches (216 × 297 mm) US letter or A4
<b>Scanning resolution</b>	4800 dpi (main scan) 4800 dpi (sub scan)

**Color depth**

Color:

48 bits per pixel internal (16 bits per pixel per color internal)

24 bits per pixel external (8 bits per pixel per color external)

Grayscale:

16 bits per pixel internal

8 bits per pixel external

Black-and-white:

16 bits per pixel internal

1 bit per pixel external

**Light source**

LED

Parent topic: [Technical Specifications](#)

## Paper Specifications

**Note:** Since the quality of any particular brand or type of paper may be changed by the manufacturer at any time, Epson cannot guarantee the quality of any non-Epson brand or type of paper. Always test a sample of paper stock before purchasing large quantities or printing large jobs.

**Single-sheets****Paper types**

Plain paper and paper distributed by Epson

**Weight**Plain paper: 17 lb (64 g/m<sup>2</sup>) to 24 lb (90 g/m<sup>2</sup>)**Envelopes****Size**

No. 10 (4.1 × 9.5 inches [105 × 241 mm])

**Weight**20 lb (75 g/m<sup>2</sup>) to 24 lb (90 g/m<sup>2</sup>)Parent topic: [Technical Specifications](#)

# Printable Area Specifications

**Note:** Print quality may decline in the shaded areas shown here due to the printer mechanism.

## Single sheets - normal printing

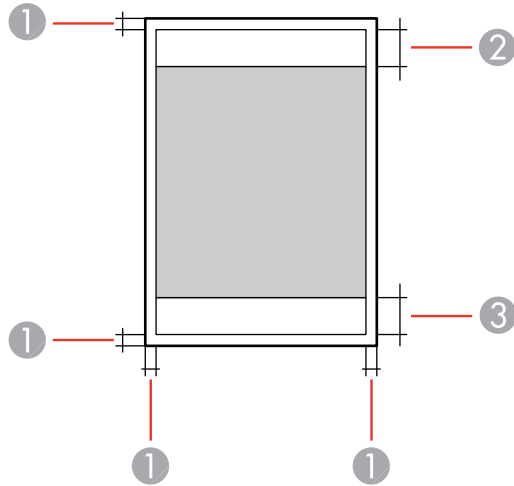

- 1 Margin: 0.12 inch (3 mm) minimum
- 2 Reduced print quality area/top: 1.61 inch (41 mm) minimum
- 3 Reduced print quality area/bottom: 1.46 inch (37 mm) minimum

## Single sheets - borderless printing

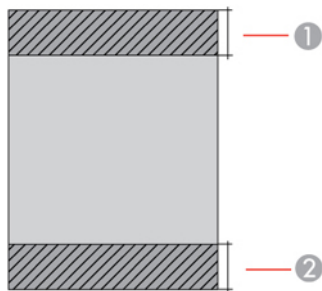

- 1 Reduced print quality area/top: 1.73 inch (44 mm) minimum
- 2 Reduced print quality area/bottom: 1.57 inch (40 mm) minimum

**Envelopes**

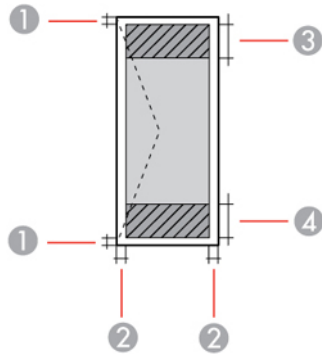

- 1 Left/right margins: 0.12 inch (3 mm) minimum
- 2 Top/bottom margins: 0.20 inch (5 mm) minimum
- 3 Reduced print quality area/right: 0.71 inch (18 mm) minimum
- 4 Reduced print quality area/left: 1.61 inch (41 mm) minimum

**CD/DVD**

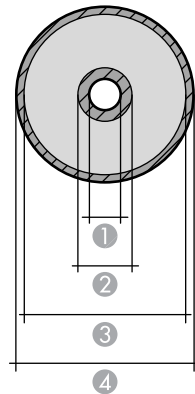

- 1 Minimum inner margin: 0.71 inch (18 mm)
- 2 Inner reduced print quality area: 1.69 inch (43 mm)
- 3 Outer reduced print quality area: 4.57 inch (116 mm)
- 4 Maximum outer margin: 4.72 inch (120 mm)

Parent topic: [Technical Specifications](#)

## Ink Cartridge Specifications

**Note:** This product uses only genuine Epson-brand cartridges. Other brands of ink cartridges and ink supplies are not compatible and, even if described as compatible, may not function properly.

The cartridges included with the printer are designed for printer setup and not for resale. After some ink is used for charging, the rest is available for printing. Yields vary considerably based on images printed, print settings, paper type, frequency of use, and temperature. For print quality, a variable amount of ink remains in the cartridge after the "replace cartridge" indicator comes on.

<b>Color</b>	Black, Cyan, Magenta, Yellow, Light Cyan, Light Magenta
<b>Cartridge life</b>	Opened package: 6 months Unopened package: do not use if the date on the package has expired
<b>Temperature</b>	Storage: -22 to 104 °F (-30 to 40 °C) 1 month at 104 °F (40 °C) Ink freezes at 3.2 °F (-16 °C) Ink thaws and is usable after 3 hours at 77 °F (25 °C)

**Note:** For best printing results, use up a cartridge within 6 months of opening the package.

Parent topic: [Technical Specifications](#)

## Memory Card Specifications

**Note:** Cards marked with an asterisk (\*) require an adapter; consult your adapter documentation for details on using it.

**Compatible types/Maximum capacities**

Memory Stick Duo: 128MB  
Memory Stick PRO Duo: 32GB  
Memory Stick PRO-HG Duo: 32GB  
MagicGate Memory Stick Duo: 32GB  
Memory Stick Micro\*: 32GB  
miniSD\*: 2GB  
miniSDHC\*: 32GB  
microSD\*: 2GB  
microSDHC\*: 32GB  
microSDXC\*: 64GB  
SD: 2GB  
SDHC: 32GB  
SDXC: 64GB  
CompactFlash: 32GB  
MicroDrive: 6GB

**Voltage requirements**

3.3 V type, dual voltage type (3.3 V and 5V); supply voltage 3.3 V  
Maximum supply current:  
Memory Stick and Memory Stick PRO: 100 mA  
SD: 200 mA  
CompactFlash and MicroDrive: 500 mA

Parent topic: [Technical Specifications](#)

## External USB Device Specifications

Do not use devices with the following requirements:

- Dedicated driver
- Security settings, such as password or encryption, etc.
- Built-in USB hub

**Note:** Use only external storage devices with independent AC power sources. External storage devices that are powered via USB are not recommended. Epson cannot guarantee the operation of externally connected devices.

<b>CD-ROM/CD-R drive</b>	700MB maximum capacity CD-RW is not supported
<b>DVD-ROM/DVD-R drive</b>	4.7GB maximum capacity DVD-RW, DVD+R, DVD+RW, DVD-RAM, and Blu-ray Disc are not supported
<b>Magneto-optical drive</b>	1.3GB
<b>Hard disk and USB flash drives</b>	2TB Formatted in FAT, FAT32, or exFAT.

Parent topic: [Technical Specifications](#)

## Dimension Specifications

<b>Height</b>	Stored: 5.8 inches (148 mm) Printing: 11.6 inches (295 mm)
<b>Width</b>	Stored: 18.9 inches (479 mm) Printing: 18.9 inches (479 mm)
<b>Depth</b>	Stored: 14.0 inches (356 mm) Printing: 26.3 inches (668 mm)
<b>Weight</b> (without ink cartridges, power cord, and CD/DVD tray)	19.2 lb (8.7 kg)

Parent topic: [Technical Specifications](#)

## Electrical Specifications

<b>Power supply rating</b>	100 to 120 V
----------------------------	--------------

<b>Rated frequency range</b>	50/60 Hz
<b>Rated current</b>	0.7 A
<b>Power consumption</b> (USB connection)	Standalone copying: Approximately 17 W (ISO/IEC24712) Ready mode: Approximately 8.2 W Sleep mode: Approximately 1.2 W Power off mode: Approximately 0.2 W

Parent topic: [Technical Specifications](#)

## Environmental Specifications

<b>Temperature</b>	Operating: 50 to 95 °F (10 to 35 °C) Storage: -4 to 104 °F (-20 to 40 °C) 1 month at 104 °F (40 °C)
<b>Humidity</b> (without condensation)	Operating: 20 to 80% RH Storage: 5 to 85% RH

Parent topic: [Technical Specifications](#)

## Interface Specifications

<b>For computer</b>	Hi-Speed USB
<b>For external USB and PictBridge devices</b>	Hi-Speed USB

**Note:** Epson cannot guarantee the operation of externally connected devices.

Parent topic: [Technical Specifications](#)

# Network Interface Specifications

## Wi-Fi

<b>Standards</b>	IEEE 802.11 b/g/n
<b>Security</b>	WEP (64/128 bit) WPA-PSK (AES); complies with WPA2 with support for WPA/WPA2 Personal
<b>Frequency range</b>	2.4 GHz
<b>Coordination modes</b>	Infrastructure mode Ad hoc mode (not supported for IEEE 802.11n) Wi-Fi Direct (not supported for IEEE 802.11b)
	<b>Note:</b> Simple AP mode is compatible with Wi-Fi infrastructure mode and Ethernet connections.

## Ethernet

<b>Standard</b>	IEEE802.3i/u (10BASE-T) IEEE802.3u (100BASE-TX) IEEE802.3az (Energy Efficient Ethernet; connected device should be IEEE802.3az compliant)
<b>Communication mode</b>	Auto, 10Mbps Full duplex, 10Mbps Half duplex, 100 Mbps Full duplex, 100Mbps Half duplex
<b>Connector</b>	RJ-45

## Security Protocol

SSL/TLS: HTTPS Server/Client, IPPS

**Parent topic:** [Technical Specifications](#)

## Safety and Approvals Specifications

### United States

Safety: UL60950-1

EMC: FCC part 15 Subpart B class B

### Canada

Safety: CAN/CSA C22.2 No. 60950-1

EMC: CAN/CSA-CEI/IEC CISPR 22 Class B

This equipment contains the following wireless module:

- Manufacturer: Askey Computer Corporation.
- Type: WLU6320-D69 (RoHS)

This product conforms to Part 15 of FCC Rules and RSS-210 of the IC Rules. Epson cannot accept responsibility for any failure to satisfy the protection requirements resulting from a non-recommended modification of the product. Operation is subject to the following two conditions: (1) this device may not cause harmful interference, and (2) this device must accept any interference received, including interference that may cause undesired operation of the device.

To prevent radio interference to the licensed service, this device is intended to be operated indoors and away from windows to provide maximum shielding. Equipment (or its transmit antenna) that is installed outdoors is subject to licensing.

This equipment complies with FCC/IC radiation exposure limits set forth for an uncontrolled environment and meets the FCC radio frequency (RF) Exposure Guidelines in Supplement C to OET65 and RSS-102 of the IC radio frequency (RF) Exposure rules. This equipment should be installed and operated so that the radiator is kept at least 7.9 inches (20 cm) or more away from a person's body (excluding extremities: hands, wrists, feet and ankles).

**Parent topic:** [Technical Specifications](#)

---

## Notices

Check these sections for important notices about your product.

**Note:** Epson offers a recycling program for end of life products. Please go to [this site](#) for information on how to return your products for proper disposal.

[Important Safety Instructions](#)

[FCC Compliance Statement](#)

[Trademarks](#)

[Copyright Notice](#)

## Important Safety Instructions

Before using your Epson product, read and follow these safety instructions.

[General Product Safety Instructions](#)

[Ink Cartridge Safety Instructions](#)

[Wireless Connection Safety Instructions](#)

[LCD Screen Safety Instructions](#)

**Parent topic:** [Notices](#)

## General Product Safety Instructions

- Be sure to follow all warnings and instructions marked on the product.
- Use only the type of power source indicated on the product's label.
- Use only the power cord that comes with the product. Use of another cord may cause fires or shock. Do not use the cord with any other equipment.
- Place the product near a wall outlet where the plug can be easily unplugged.
- Avoid plugging the product into an outlet on the same circuit as a photo copier or air control system that regularly switches on and off, or on an outlet controlled by a wall switch or timer.
- Do not let the power cord become damaged or frayed. Place it to avoid abrasions, cuts, fraying, crimping, and kinking. Do not place objects on top of it and do not allow it to be stepped on or run over. Be careful to keep the cord straight at each end.
- If you use an extension cord with the product, make sure the total ampere rating of the devices plugged into the extension cord does not exceed the cord's ampere rating. Also, make sure the total

ampere rating of all devices plugged into the wall outlet does not exceed the wall outlet's ampere rating.

- Always turn off the product using the power button, and wait until the power light stops flashing before unplugging the product or cutting off power to the electrical outlet.
- If you will not be using the product for a long period, unplug the power cord from the electrical outlet.
- Place the product on a flat, stable surface that extends beyond its base in all directions. It will not operate properly if it is tilted or at an angle.
- Allow space behind the product for the cables, and space above the product so that you can fully raise the document cover.
- Leave enough space in front of the product for the paper to be fully ejected.
- Avoid locations that are subject to rapid changes in heat or humidity, shocks or vibrations, or dust.
- Do not place or store the product outdoors.
- Do not place the product near excessive heat sources or in direct sunlight.
- Leave enough room around the product for sufficient ventilation. Do not block or cover openings in the case or insert objects through the slots.
- Keep the product away from potential sources of electromagnetic interference, such as loudspeakers or the base units of cordless telephones.
- When connecting the product to a computer or other device with a cable, ensure the correct orientation of the connectors. Each connector has only one correct orientation. Inserting a connector in the wrong orientation may damage both devices connected by the cable.
- Do not touch the flat white cable inside the product.
- Do not move the print head by hand; this may damage the product.
- Do not spill liquid on the product or use the product with wet hands.
- Do not use aerosol products that contain flammable gases inside or around the product. Doing so may cause fire.
- Do not press too hard on the document table when placing originals.
- Do not open the scanner section while the product is copying, printing, scanning, or performing any other functions.
- Be careful not to trap your fingers when closing the document cover or scanner.
- Except as specifically explained in your documentation, do not attempt to service the product yourself.
- Unplug the product and refer servicing to qualified service personnel under the following conditions: if the power cord or plug is damaged; if liquid has entered the product; if the product has been dropped

or the case damaged; if the product does not operate normally or exhibits a distinct change in performance. Adjust only those controls that are covered by the operating instructions.

- Leave the ink cartridges installed. Removing the cartridges can dehydrate the print head and may prevent the product from printing.
- Before transporting the product, make sure that the print head is in the home (far right) position and the ink cartridges are in place.
- When storing or transporting the product, do not tilt it, stand it on its side, or turn it upside down; otherwise ink may leak.

**Parent topic:** [Important Safety Instructions](#)

## **Ink Cartridge Safety Instructions**

- Keep ink cartridges out of the reach of children and do not drink the ink.
- Be careful when you handle used ink cartridges; there may be ink remaining around the ink supply port. If ink gets on your skin, wash it off with soap and water. If it gets in your eyes, flush them immediately with water.
- Do not put your hand inside the product or touch any cartridges during printing.
- Install a new ink cartridge immediately after removing an expended one. Leaving cartridges uninstalled can dry out the print head and may prevent the product from printing.
- Do not remove or tear the label on the cartridge; this can cause leakage.
- Do not remove the transparent seal from the bottom of the cartridge. This may cause the cartridge to become unusable.
- Do not break the hooks on the side of the cartridge when removing it from the packaging.
- Do not touch the green IC chip on the side of the cartridge. This may prevent normal operation.
- Do not shake cartridges after opening their packages; this can cause them to leak.
- If you remove an ink cartridge for later use, protect the ink supply area from dirt and dust and store it in the same environment as the product. Note that there is a valve in the ink supply port, making covers or plugs unnecessary, but care is needed to prevent the ink from staining items that the cartridge touches. Do not touch the ink cartridge ink supply port or surrounding area.
- Use an ink cartridge before the date printed on its package.
- Do not dismantle an ink cartridge. This could damage the print head.
- Store ink cartridges in a cool, dark place.

- After bringing an ink cartridge inside from a cold storage site, allow it to warm up at room temperature for at least three hours before using it.
- Store ink cartridges with their labels facing upward. Do not store cartridges upside down.

**Parent topic:** [Important Safety Instructions](#)

## Wireless Connection Safety Instructions

Radio waves from this product may adversely affect the operation of medical equipment or automatically controlled devices, such as pacemakers, automatic doors or fire alarms. When using this product near such devices or inside a medical facility, follow the directions from authorized staff members at the facility, and follow all posted warnings and directions on the device to avoid causing an accident.

**Parent topic:** [Important Safety Instructions](#)

## LCD Screen Safety Instructions

- Use only a dry, soft cloth to clean the LCD screen. Do not use liquid or chemical cleansers.
- If the LCD screen is damaged, contact Epson. If the liquid crystal solution gets on your hands, wash them thoroughly with soap and water. If the liquid crystal solution gets into your eyes, flush them immediately with water. If discomfort or vision problems remain after a thorough flushing, see a doctor immediately.
- Do not press too hard on the LCD screen.
- Do not use a pointy or sharp object, such as a pen or your fingernail, to operate the LCD screen.

**Parent topic:** [Important Safety Instructions](#)

## FCC Compliance Statement

### For United States Users

This equipment has been tested and found to comply with the limits for a Class B digital device, pursuant to Part 15 of the FCC Rules. These limits are designed to provide reasonable protection against harmful interference in a residential installation. This equipment generates, uses, and can radiate radio frequency energy and, if not installed and used in accordance with the instructions, may cause harmful interference to radio or television reception. However, there is no guarantee that interference will not occur in a particular installation. If this equipment does cause interference to radio and television reception, which can be determined by turning the equipment off and on, the user is encouraged to try to correct the interference by one or more of the following measures:

- Reorient or relocate the receiving antenna.
- Increase the separation between the equipment and receiver.

- Connect the equipment into an outlet on a circuit different from that to which the receiver is connected.
- Consult the dealer or an experienced radio/TV technician for help.

### **WARNING**

The connection of a non-shielded equipment interface cable to this equipment will invalidate the FCC Certification or Declaration of this device and may cause interference levels which exceed the limits established by the FCC for this equipment. It is the responsibility of the user to obtain and use a shielded equipment interface cable with this device. If this equipment has more than one interface connector, do not leave cables connected to unused interfaces. Changes or modifications not expressly approved by the manufacturer could void the user's authority to operate the equipment.

### **For Canadian Users**

CAN ICES-3(B)/NMB-3(B)

Parent topic: [Notices](#)

## **Trademarks**

EPSON® is a registered trademark, EPSON Exceed Your Vision is a registered logomark, and Epson Connect™, Epson iPrint™ and Remote Print™ are trademarks of Seiko Epson Corporation.

Epson Store<sup>SM</sup> is a service mark of Epson America, Inc.

Apple, iPad, iPhone, iPod touch, Mac, and OS X are trademarks of Apple Inc., registered in the U.S. and other countries. AirPrint and the AirPrint logo are trademarks of Apple Inc.

Google® is a registered trademark and Android™, Chromebook™, Google Chrome™, Google Cloud Print™, and Picasa™ are trademarks of Google Inc.

Wi-Fi Direct® is a registered trademark of Wi-Fi Alliance®.

General Notice: Other product names used herein are for identification purposes only and may be trademarks of their respective owners. Epson disclaims any and all rights in those marks.

**EPSON**<sup>®</sup>  
EXCEED YOUR VISION

Parent topic: [Notices](#)

## Copyright Notice

All rights reserved. No part of this publication may be reproduced, stored in a retrieval system, or transmitted in any form or by any means, electronic, mechanical, photocopying, recording, or otherwise, without the prior written permission of Seiko Epson Corporation. The information contained herein is designed only for use with this Epson product. Epson is not responsible for any use of this information as applied to other products.

Neither Seiko Epson Corporation nor its affiliates shall be liable to the purchaser of this product or third parties for damages, losses, costs, or expenses incurred by purchaser or third parties as a result of: accident, misuse, or abuse of this product or unauthorized modifications, repairs, or alterations to this product, or (excluding the U.S.) failure to strictly comply with Seiko Epson Corporation's operating and maintenance instructions.

Seiko Epson Corporation shall not be liable for any damages or problems arising from the use of any options or any consumable products other than those designated as Original Epson Products or Epson Approved Products by Seiko Epson Corporation.

Seiko Epson Corporation shall not be held liable for any damage resulting from electromagnetic interference that occurs from the use of any interface cables other than those designated as Epson approved Products by Seiko Epson Corporation.

This information is subject to change without notice.

[A Note Concerning Responsible Use of Copyrighted Materials](#)  
[Default Delay Times for Power Management for Epson Products](#)  
[Copyright Attribution](#)

**Parent topic:** [Notices](#)

## A Note Concerning Responsible Use of Copyrighted Materials

Epson encourages each user to be responsible and respectful of the copyright laws when using any Epson product. While some countries' laws permit limited copying or reuse of copyrighted material in certain circumstances, those circumstances may not be as broad as some people assume. Contact your legal advisor for any questions regarding copyright law.

**Parent topic:** [Copyright Notice](#)

## Default Delay Times for Power Management for Epson Products

This product will enter sleep mode after a period of nonuse. This is to ensure that the product meets Energy Star standards of energy efficiency. More energy savings can be achieved by setting the time to sleep to a shorter interval.

**Parent topic:** [Copyright Notice](#)

## **Copyright Attribution**

© 2015 Epson America, Inc.

9/15

CPD-42858R1

**Parent topic:** [Copyright Notice](#)