



TYPHOON



USER MANUAL RS-V1.2

TABLE OF CONTENTS

01	TABLE OF CONTENTS	15	- FLIGHT MODES
02	INTRODUCTION	17	CAMERA CONTROLS
02	OVERVIEW	17	- SINGLE MODE
03	SPECIFICATIONS	17	- TEAM MODE
04	PLACEMENT BEFORE TAKEOFF	18	- TAKING PHOTOS AND RECORDING VIDEO
04	CHARGING	19	GPS FUNCTIONALITY / DISABLING GPS
04	ASSEMBLY	19	CREATE A NEW MODEL
05	POWERING ON / OFF	19	- PREPARING THE ST16
05	STARTING/STOPPING THE MOTORS	19	- BINDING THE TYPHOON H
06	FLIGHT CONTROLS (SINGLE MODE)	20	GUI INSTRUCTION
06	- ST16 OVERVIEW	21	CALIBRATION
07	- FLYING	21	- COMPASS CALIBRATION
07	- LANDING	22	- GIMBAL CAMERA CALIBRATION
07	- PROPORTIONAL CONTROL RATE SLIDER	22	- ACCELEROMETER CALIBRATION
08	- FLIGHT MODES	22	UPDATE
08	- FOLLOW ME FUNCTION	23	LED STATUS INDICATIONS
08	- WATCH ME FUNCTION	24	Wizard™ LED STATUS
11	- ADDITIONAL FUNCTIONS	24	NOTICES AND WARNINGS
13	FLIGHT CONTROLS (TEAM MODE)	25	GENERAL SAFETY PRECAUTIONS AND WARNINGS
14	TEAM MODE (TWO ST16 Ground Stations)	26	LIPO BATTERY WARNINGS AND USAGE GUIDELINES
14	TEAM MODE (WIZARD™ & ST16)	27	DISCLAIMER
15	WIZARD BUTTON COMBINATION FUNCTIONS	28	CERTIFICATION INFORMATION
15	- FLIGHT CONTROLS		

INTRODUCTION

Typhoon H is an advanced aerial photography and videography platform, perfect for skilled pilots and photographers alike. It offers up to 25 minutes of flight time while filming with the CGO3+ 4K-resolution camera. Settings can be freely and remotely adjusted through the ST16 Personal Ground Station, an easy and intuitive remote controller which features a 7-inch Android touchscreen that displays live footage of your flight. To meet different needs for function and portability, Typhoon H has two configurations: the professional version with Intel RealSense, equipped with a portable backpack, and the advanced version with Sonar Collision Avoidance, which features an upgrade path to the professional version with the purchase of a RealSense module, sold separately. Typhoon H with Intel® RealSense™ technology builds a 3D model of the world. The Intel® RealSense™ module provides high quality depth to the host system and enables the drone to make intelligent choices about creating routes around obstacles.

OVERVIEW

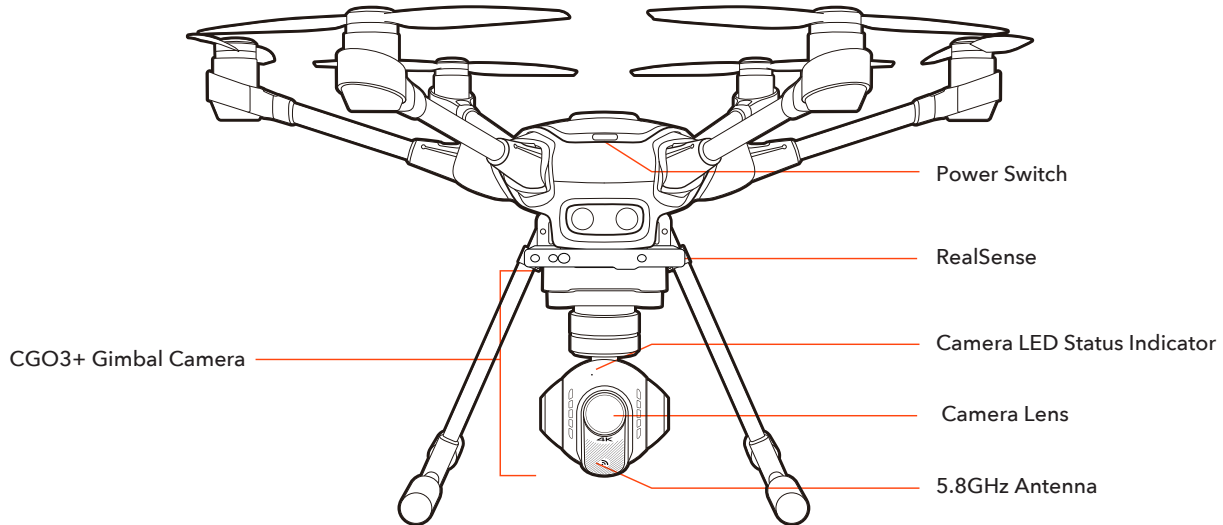

SPECIFICATIONS

TYPHOON H SPECIFICATIONS

Flight Time	Up to 25 min	Maximum Rotation Rate	85°/s
Size	20.5x18x12.2 in (520x457x310mm)	Maximum Roll Angle	35°
Takeoff Weight	69.8oz (1980g)	Maximum Climbing Speed	11.2 MPH (5m/s)
Battery	4S 14.8V LiPo Battery (POWER 4)	Maximum Speed In Angle Mode	30.2 MPH (13.5m/s)
Battery Capacity/Voltage	5400mAh 4S/14.8V (79.9Wh)	Maximum Descending Speed	6.7 MPH (3m/s)
Charger	SC4000-4	Diagonal Wheelbase	18.9 in (480mm)
Transmitter	ST16 Personal Ground Station	Frame Arm Length	7.4 in (187mm)
Maximum Flying Height	122m (400ft)(Restricted by FAA)	Landing Gear Size	10.4x7.3 in (265x185mm)

REALSENSE SPECIFICATIONS

Weight	70g	Ground to IPS Distance	14.8ft (4.5m)
Dimensions	6.0*4.2in (153*107mm)	Maximum Speed under Module Collision Avoidance	11.2mph (5m/s)
Maximum Detecting Distance from Forward Facing Obstacles	32.8ft (10m)	Field of view (Vertical)	40°
Distance Front Collision Avoidance	9.8ft to 23ft (varying according to the environment)	Field of view (Horizontal)	60°

CGO3+ (CGO3 PLUS) SPECIFICATIONS

Weight	9.0oz (255g)	Electronic Shutter	1/30-----1/8000s
Effective Pixels	12.4 Megapixels	Video Transmission Range	Up to 1.2mile (2km)
Camera Lens	14mm/F2.8	Transmission System	5.2GHz – 5.8GHz
Number of Axis	3	Video UHD	4K UHD 30fps

ST16 GROUND STATION

Operating System:	Android™	Video Transmission Distance/Range (Optimum Conditions):	FCC Compliance: Up to 1.2 mile (2km) CE Compliance: Up to 1.2 mile (2km)
Number of Channels:	16	LCD Screen Size:	7"
Control Transmission Distance/Range:	Up to 1 Mile (1.6km) (Optimum Conditions)	Built-In Li-ion Battery Voltage / Capacity:	3.6V 8700mAh 31.32Wh Li-ion
Video Link Frequency Band:	5.8GHz WiFi		

PLACEMENT BEFORE TAKEOFF

WARNING: Always operate Typhoon H in open areas (approximately 10000 square feet/930 square meters or more) that are free from people, vehicles, trees and other obstructions. Never fly near or above crowds, airports or buildings.

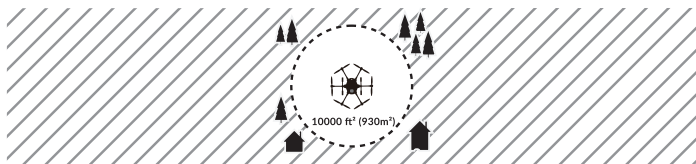

Never attempt to operate Typhoon H nearby tall buildings/obstructions that do not offer a clear view of the sky (a minimum clearance of 100°). Be sure to place Typhoon H on a level and stable surface before powering ON the Ground Station and the aircraft.

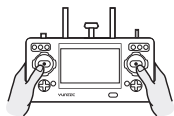
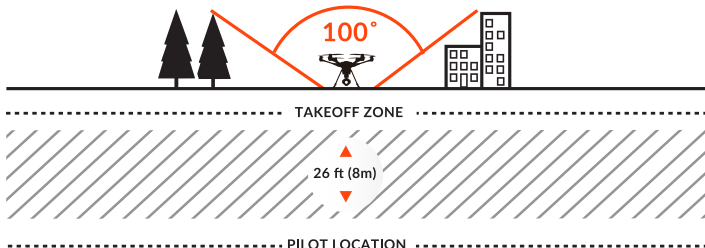

IMPORTANT NOTE: STEP BACK APPROXIMATELY 26 FEET (8 METERS) BEHIND THE Typhoon H.

NOTICE: Pilots are recommended to take off the aircraft under Angle Mode. If the pilot takes off the aircraft under Smart Mode, make sure to keep the aircraft 32.8ft (10m) away from the pilot.

NOTICE: For the best performance, the 5.8GHZ patch antenna should be pointed to the aircraft for better performance.

CHARGING

Power the SC4000-4 charger from a 100-240V AC outlet using the AC adapter/power supply, or from a 12V-16.8V DC accessory socket/cigarette lighter receptacle in a vehicle using the included adapter.

Plug the aircraft battery into the charger port as illustrated.

A green blinking LED indicates the charger is powered on and ready to charge, and a red blinking LED indicates the battery is charging. It will take approximately 2.5 hours to charge a fully discharged (not over-discharged) battery. A solid green LED indicates the battery is fully charged.

WARNING: All instructions and warnings must be followed exactly to prevent property damage and/or serious injury as the mishandling of Li-ion/LiPo batteries can result in fire.

FOR THE ST16 GROUND STATION

You can charge the ST16 battery by using supplied USB cable and inserting it into the USB port on the charger. It will take approximately 5 hours to charge a fully discharged (not over-discharged) battery.

WARNING: Do not leave the battery in the charger after the battery is fully charged.

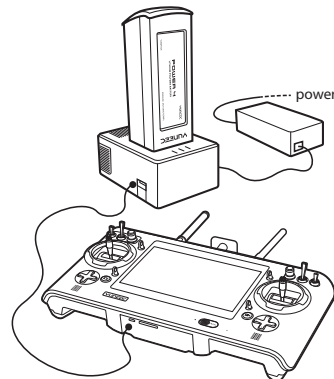

ASSEMBLY

STEP 1: ASSEMBLING THE ARMS

Unfold the motor arms and secure them until hearing a 'click'.

NOTICE: Press the 'PRESS' button to fold the motor arms.

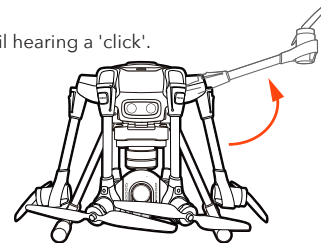
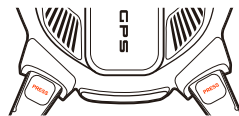

STEP 2: INSTALLING THE PROPELLERS

IMPORTANT NOTE: Always ensure propellers are installed properly. The motors are extremely powerful, meaning that if the device is misused there is a risk of material damage, serious injury and even fatal injury.

Mount the propellers on the motors and note the 'A' and 'B' given on the motor arms. This distinction between 'A' and 'B' refers to propeller 'A' and 'B'. Mount propeller 'A' on motor 'A' and propeller 'B' on motor 'B', press and rotate propellers in the direction the [] points to, and the propellers will be locked.

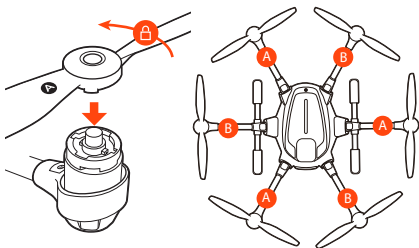

NOTICE: Press and hold the center button on the propeller and rotate the propeller in the direction the [] points to, then you can disassemble the propellers.

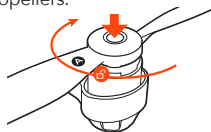

STEP 3: INSTALLING THE FLIGHT BATTERIES

Push the battery into the battery compartment with the Yuneec logo facing upwards until hearing a 'click', which means the battery is installed successfully.

NOTICE: Gently open the battery cap to the maximum degree (to a position where is almost horizontal with the GPS cover), then you can pull the battery out.

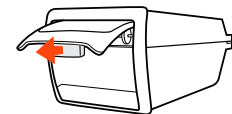

STEP 4: REMOVE THE PROTECTIVE COVER AND INSERT THE SD CARD

Carefully remove the protective cover from the camera lens. Insert the included 16GB card or any Class 10 microSD card (U3 speed capable of 4K data rates) from 16GB to 128GB.

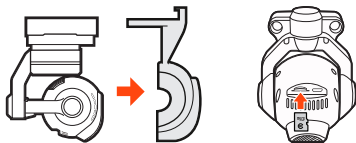

POWERING ON / OFF

NOTE: ALWAYS turn on the ST16 Ground Station and allow it to boot up BEFORE turning Typhoon H on (and ALWAYS turn Typhoon H off BEFORE turning off the ST16 Ground Station).



Place Typhoon H on a level and stable surface then power on the ST16 Ground Station. Press and hold power button on Typhoon H. Release the button when the aircraft emits a rising tune. DO NOT TOUCH OR MOVE THE Typhoon H UNTIL THE INITIALIZATION PROCESS IS COMPLETE. The gimbal camera will spin to the front position.

NOTICE: If the main LED blinks red slowly, the initialization has failed. The aircraft needs to be powered on again. To power off the aircraft, press and hold the power button until the aircraft emits a falling tune.

NOTICE: After hearing a rising tune, the main LED indicator will blink green for 1 to 2 seconds once with flight battery fully charged, yellow with half charged and red with low voltage.

STARTING/STOPPING THE MOTORS

NOTICE: Only with sustainable GPS or IPS activated or GPS being turned off, the motors can be started or stopped by pressing the START/STOP button.

NOTICE: After the GPS is turned off, IPS will be turned off automatically and the indoor positioning function will be disabled.

OPTION 1

Press and hold the START / STOP button for about 3 seconds to start, and about 2 seconds to stop the motors. Step back approximately 26 feet (8 meters) behind Typhoon H, make sure the ST16 Ground Station is in the Angle mode. When there is suitable GPS signal for both the ST16 Ground Station and Typhoon H, or IPS for the aircraft, you can start the motors.

OPTION 2

With the GPS of both the aircraft and the ST16 Ground Station locked, the pilot can select Camera/Task switch icon, and tap the Take Off on the task row. Make sure the pilot is more than 5 meters away from the aircraft and then slide the icon on the screen, the aircraft will take off and hover at default height.



FLIGHT CONTROLS (SINGLE MODE)

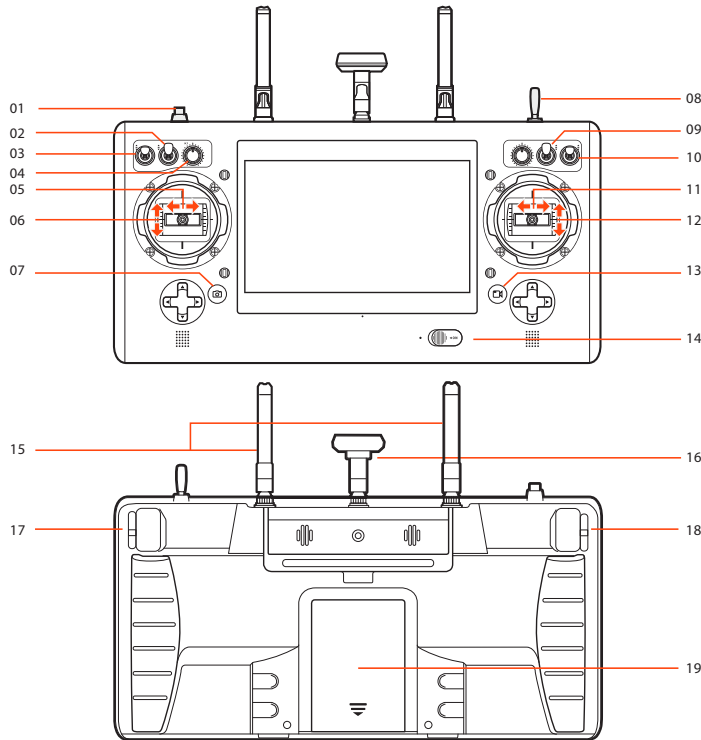

ST16 OVERVIEW

- 01 Start/Stop Motors Button
- 02 Gimbal Pan Mode (Follow Mode/Follow Pan Controllable Mode/Global Mode)
- 03 Gimbal Tilt Mode (Angle Mode/ Velocity Mode)
- 04 Gimbal Pan Control
- 05 Rudder/Yaw Control (Mode 2 and Mode 1)
- 06 Throttle/Altitude Control (Mode 2)
Elevator/pitch control (Mode 1)
- 07 Take Still Photo Button
- 08 Landing Gear Switch
- 09 Obstacle Avoidance Switch
- 10 Flight Mode Selection Switch
- 11 Aileron/Roll Control (Mode 2 and Mode 1)
- 12 Elevator/Pitch Control (Mode 2)/Throttle joystick (mode 1)
- 13 Start/Stop Video Recording Button
- 14 Power Switch
- 15 Antenna
- 16 5.8GHz patch antenna
- 17 Proportional Control Rate Slider
- 18 Gimbal Tilt Control Slider
- 19 Battery

CLIMB MAX ALTITUDE
400 FEET / 122 METERS

MAINTAIN ALTITUDE

DESCEND / LAND

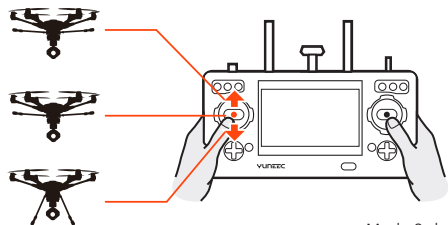

Mode 2 shown

To take off, slowly raise the left-hand stick to above the center position. Typhoon H will take off and climb slowly (or raise the stick further until it does). Allow the stick to return to the center position when Typhoon H reaches the desired altitude.

FLYING (OBS AVOID OFF)

Take your time learning how Typhoon H responds to various control inputs while flying. In Smart Mode, Typhoon H will always move in the direction the right-hand control stick is pushed relative to the pilot and no matter which way the front/nose is pointed.

In Angle (Pilot) Mode, Typhoon H will move in the direction the control stick is pushed relative to the front/nose of the aircraft (and the 'angle' of movement is determined by how far you push the stick away from the center position).

FLYING(OBS AVIOD ON)

In the smart mode ,the TYPHOON H will always move in the direction the right-hand control stick is pushed. The TYPHOON H will turn its nose in accord with the direction it will fly first, then move forward in the direction. The aircraft will avoid obstacles automatically and then fly according to the remote control.

In Angle mode, the aircraft will stop in front of the obstacle.

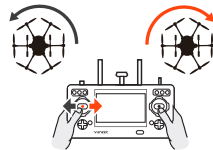

IMPORTANT NOTE: If at any time during flight you feel like Typhoon H is drifting out of/beyond your control, simply release both control sticks. Typhoon H will automatically self-level and will even hold its position (with a suitable GPS signal/lock and OBS AVOID off) when both control sticks are centered. You can also activate Home Mode and Typhoon H will automatically fly itself back to the home point and lands.

LANDING - There are two ways to land Typhoon H:

1) Position Typhoon H above the area where you would like to land. Slowly lower the left-hand stick to below the center position. Typhoon H will descend slowly and land. After Typhoon H lands, press and hold the START/STOP button until the motor stops.

NOTICE: It is recommended to turn off the Obstacle Avoidance when landing.

2) Activate Home Mode and Typhoon H will automatically fly itself back to the home point and land.

NOTICE: After the copter takes off, the pilot can retract the landing gear by switching up the Landing Gear Switch on the top right side of the ST16 Ground Station. Make sure to flip the switch to the downward position when landing.

NOTICE: During the landing phase of the RTH you can fine tune the landing location. As the aircraft nears the ground refrain from touching the direction controls as this can cause the aircraft to tip over.

WARNING: Always land as soon as possible after the first low level voltage battery warning, or land immediately after the second level low voltage battery warning (as indicated by the vibrations and audible alerts from the ST16 Ground Station, and by the Motor LED Status Indicators flashing rapidly). If at any time the Aircraft Battery Voltage shown on the screen is below 14.1V, land Typhoon H immediately.

NOTICE: When the aircraft gives the first-level low voltage warning, it will exit the TASK mode and the functions under the TASK mode won't be activated.



AFTER LANDING

NOTICE: When the landing gear is lowered down with OBS Switch on, the TYPHOON H can't fly back in front of the obstacle. When the obstacle moves towards the TYPHOON H, the aircraft won't fly back automatically. If the aircraft is controlled flying towards the obstacle by the pilot, it will stop in front of the obstacle (when in Angle Mode), or steer clear of the obstacle (when in Smart Mode).

ALWAYS turn off Typhoon H BEFORE turning off the ST16 Ground Station. Then remove the battery from Typhoon H and allow it to cool to ambient/room temperature before recharging.

NOTICE: If the signal of the remote control is lost, Typhoon H will automatically return to the home point and hold its position (with a suitable GPS signal/lock) over the home position (except for low battery).



PROPORTIONAL CONTROL RATE SLIDER

The Proportional Control Rate Slider located on the right side of the ST16 Ground Station allows you to set the overall climb/descend and directional control rates. Use the turtle position for the lowest control rates (best for first-time pilots and required when flying between 5000 feet and 8000 feet Above Mean Sea Level), and use the rabbit position for the highest control rates (best for experienced pilots and can only be used when flying below 5000 feet MSL). Or use a position in between if you prefer.



FLIGHT MODES

The ST16 Ground Station is equipped with 3 different flight modes which can be selected by using the mode switch in the top right corner above the right joystick.

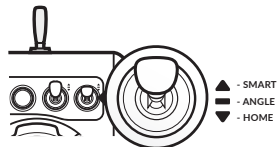

SMART MODE

When the Flight Mode selection switch is in the top position Typhoon H will be in Smart Mode. Although we recommend learning to fly Typhoon H in Angle (Pilot) Mode as soon as possible, Smart Mode is typically the best mode for beginning pilots to fly in and also features 'Follow Me'.

In Smart Mode (with OBS AVOID OFF) Typhoon H will always move in the direction the right-hand control stick is pushed relative to the pilot and no matter which way the front/nose is pointed. So if you push the stick to the left, Typhoon H will always move to the left, regardless of the direction the nose is pointing and even if it's spinning. This mode can also be helpful for pilots that lose orientation while flying in Angle (Pilot) Mode.

NOTICE: In smart mode (with OBS AVOID ON), the Typhoon H will always move in the direction the right-hand control stick is pushed relative to the pilot. The TYPHOON H will turn its nose in accord with the direction it will fly first, then move forward in the direction. The aircraft will avoid obstacles automatically and then fly according to the remote control.

*ADDITIONAL SMART MODE FEATURES

FOLLOW ME

The Follow Me function allows Typhoon H to follow the pilot, adjusting its location to the location of the ST16 Ground Station. This function is enabled when ST16's GPS positioning completes, and Typhoon H is using shared GPS signal with the ST16 Ground Station. When Follow Me is activated, the background of the 'Follow' character will be red and the icon of Follow [▲] will be highlighted in white. Typhoon H will follow the movement of ST16 Ground Station if there is no extra operation on the ST16 Ground Station. The flight status is also controllable when you operate the ST16 and CGO3+.

IMPORTANT NOTE: After switching on OBS AVOID in Follow Me/Watch Me, the TYPHOON H will steer clear of the obstacle while following the pilot. The distance between the pilot and the aircraft might be farther result from the obstacle.

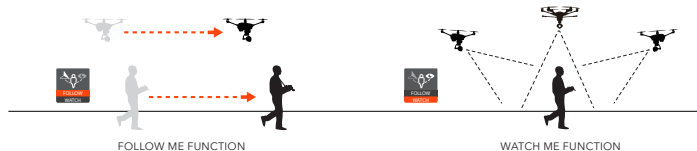
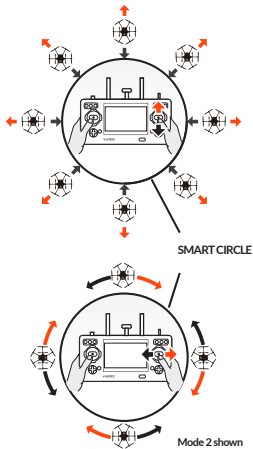

WATCH ME

Watch Me enables the camera to keep tracking the remote controller no matter where and how it moves as the camera automatically tilt its angle according to the controller. Usually, the default function under Smart Mode is Follow Me. Watch Me function can be switched to by following steps:

Watch Me/Follow Me Button: When in Smart Mode, press [▲] to switch Typhoon H between the Watch Me and Follow Me function. The Follow Me function is the default setting, and the icon of Follow will be highlighted white and the background of Follow character will turn red. If it is NOT AVAILABLE, it means the ST16's GPS isn't ready yet. Please wait.

Press [▲], and the background of the 'Watch' character will turn red and the icon of Watch [●] will be highlighted white. The Follow [▲] will turn grey and the background of the Follow character will turn black. This means the Watch Me function is now enabled. During Watch Me, you can trim the gimbal pan position by adjusting pan control knob on ST16.

NOTICE: We recommend to set the Tilt knob in the center position in the Watch Me function. The pilot can also change the tilt direction of the gimbal camera by rotating the Tilt knob.

SMART CIRCLE

In most cases the Smart Circle will keep Typhoon H from coming within approximately 26 feet (8 meters) of you (as long as you position yourself at least 26 feet/8 meters behind Typhoon H).

GEO-FENCE

The geo-fence is a virtual barrier that will keep Typhoon H from traveling farther than 300 feet (91 meters). The geo-fence only works in Smart Mode. Although this limit can be adjusted using the GUI we strongly recommend using the default limit at all times.

WARNING: Smart Mode only works when Typhoon H has a suitable GPS signal/lock. If you are flying in Smart Mode and Typhoon H loses GPS signal/lock it will switch to Angle (Pilot) Mode automatically. This is why we strongly recommend learning to fly in Angle (Pilot) Mode as soon as possible. Otherwise, if you lose GPS signal/lock and are not able to properly control Typhoon H in Angle (Pilot) Mode the aircraft may crash or even 'fly away'.

IMPORTANT NOTE: Crash damage and 'fly away' are NOT covered under warranty.

IMPORTANT NOTE: When the ST16 Ground Station is connected to less than 6 satellites, the 'FOLLOW ME' feature will be disabled.

NOTICE: If the landing gear is not lowered down in Smart and Angle modes during landing, the aircraft can't descend less than 6.6 feet (2 meters) from the ground.

NOTICE: When turning off the Realsense, the maximum speed of the TYPHOON H should be less than 37.3MPH. When turning on the Realsense, the maximum speed should be less than 11.2 MPH.

ANGLE MODE

When the Flight Mode selection switch is the middle position, Typhoon H will be in Angle Mode, also known as in Pilot Mode.

Angle (Pilot) Mode is the mode preferred by experienced RC/drone pilots because Typhoon H will move in the direction the control stick is pushed relative to the front/nose of the aircraft. So if you push the right-hand stick to the left Typhoon H will bank toward the left side and move to the left. This means if the front/nose of Typhoon H is pointing away from you it will move to the left, but if the front/nose is pointing at you Typhoon H will move to the right.

NOTICE: When in the Angle Mode, the aircraft will stop in front of the obstacle with realsense activated.

*ADDITIONAL ANGLE (PILOT) MODE FEATURE:

The Typhoon H will automatically hold its position (with a suitable GPS signal/lock) and maintain a level attitude when the both joysticks are centered.

WARNING: If you do not properly control Typhoon H in Angle (Pilot) Mode the aircraft may crash or even 'fly away'.

IMPORTANT NOTE: Crash damage and 'fly aways' are NOT covered under warranty.

OBSTACLE AVOID Switch

With sustainable GPS locked, the realsense can be activated in any mode by being switched on except for the condition that the copter descend vertically at low speed with landing gear down. When the realsense is activated, the front motor LEDs will blink white and the icon on the ST16 screen will be solid green. If the OBSTACLE AVOID is switched on, but the function can't be activated, then the icon will be yellow.

IMPORTANT NOTE: The environment requirement such as flight track might change depending on the situation. Only when the icon on the ST16 screen is solid green, it means the OBSTACLE AVOID function is activated.

NOTICE: The realsense can only detect the front obstacles, but can't detect the lateral and rear obstacles.

NOTICE: The speed of the aircraft will be limited with realsense activated.

NOTICE: For the most up-to-date information of OBSTACLE AVOID, please visit the corresponding product page at www.Yuneec.com or contact the nearest Yuneec office or authorized distributor.

NOTICE: It is recommended to turn off Obstacle Avoid when landing. If the landing gear is lowered down, the aircraft won't recede in angle mode when the realsense detect the obstacle.

INDOOR POSITIONING SYSTEM

In Angle Mode, the TYPHOON H will automatically activate the IPS or not. When GPS can't be locked, if the flight control activate the IPS, the Main LED indicator of the aircraft will be solid purple, and the GPS will display being searching on the Remote control, which indicates IPS is activated automatically. At the same time, the aircraft can't be switched to Smart Mode, Home Mode, Task Mode and OBS AVOID, ONLY remain in Angle Mode even if switching the mode switch. When using IPS to lock the position of the aircraft, TYPHOON H can also hover at its current altitude automatically. The IPS is most suitable for indoor flight or without GPS locked.

NOTICE: When flying in door with IPS activated, the pilot should be cautious and not to fly too fast.

NOTICE: When using IPS without GPS locked, make sure that the indoor illumination is sufficient. The IPS may not be able to position when the aircraft is flying over highly reflective surfaces or over highly repeated surface texture (such as the same color).

HOME MODE

When the Flight Mode selection switch is in the bottom position, Typhoon H will be in Home (also known as Return to Home) Mode.

In Home Mode the GPS connectivity will fly back Typhoon H in a straight line in the direction of the pilots' current location, and automatically land within 13-26 ft (4-8m) of the pilot. This can be very helpful for beginning pilots who aren't quite ready to land Typhoon H themselves. It can also be helpful for pilots that lose orientation during flight. Simply activate Home Mode until Typhoon H automatically

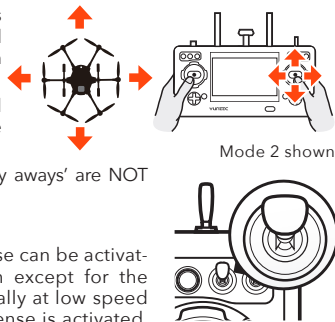

moves toward the home position, and once you've confirmed orientation switch back to Angle (Pilot) Mode. If Typhoon H ever loses the link with the ST16 Ground Station it will automatically enter Home Mode.

NOTICE: If the signal of remote control is lost, Typhoon H will automatically return to home point and hold its position (with a suitable GPS signal/lock) over the home position except for low battery.

NOTICE: If switching on OBS AVOID in Home Mode, the TYPHOON H will avoid the obstacle during home mode. The flight speed (only for RealSense Version) will be limited.

Before switching to Home Mode, press the Setting Calibration button on the right task column. Select Home Altitude and set a height as the desired altitude, and then Home Mode can be activated. The flight path is as follows:

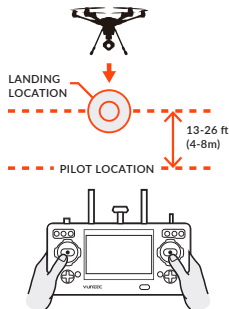

REALSENSE TURNED OFF

1. When the flight height of the aircraft is lower than the desired altitude, it will climb to the desired altitude vertically first, then fly back at the current height and descend vertically within 13-26 ft (4-8m) of the pilot until it lands automatically.

2. When the flight height of the aircraft is higher than the desired altitude, it will fly back at the current height, then descend vertically within 13-26 ft (4-8m) of the pilot until it lands automatically.

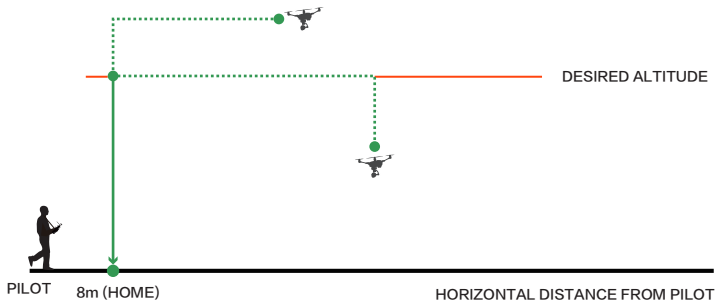

REALSENSE TURNED ON

1. When the flight height of the aircraft is lower than the desired altitude, the aircraft will climb to the desired altitude, meanwhile, it will fly back to the home point, and then descend vertically within 13-26 ft (4-8m) of the pilot until it lands automatically.

2. When the flight height of the aircraft is higher than the desired altitude, the aircraft will descend to the desired altitude, meanwhile, it will fly back to the home point, and then descend vertically within 13-26 ft (4-8m) of the pilot until it lands automatically.

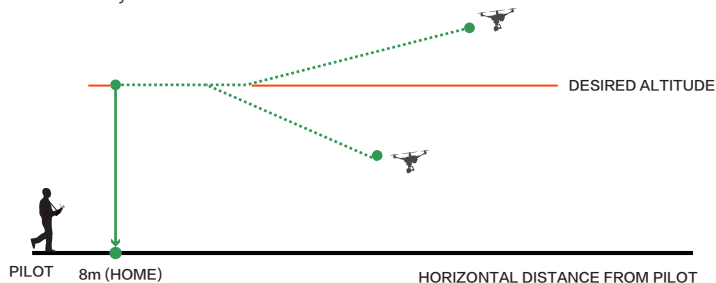

NOTICE: The default home altitude is 20m (65.6ft). But after the home altitude is reset, the latest data will be saved as the new default home altitude.

NOTICE: Users can control pitch, roll and yaw directions during descent.

NOTICE: After the Home Mode is activated, the aircraft will point its nose to the home point automatically. After the aircraft arrives home point and begins to descend, it will turn its tail pointing to the pilot.

CAUTION: With OBS. AVOID switched off, you must be certain there are no obstacles in the 'Return to Home' flight path otherwise Typhoon H may come into contact with them and crash. While Typhoon H is in Home Mode you will have a limited amount of directional control. To help avoid obstacles we strongly recommend switching to Smart or Angle Mode (then you can switch back to Home Mode).

WARNING: Home Mode only works when Typhoon H has a suitable GPS signal/lock. If Typhoon loses GPS signal/lock it will switch to Angle (Pilot) Mode automatically. This is why we strongly recommend learning to fly in Angle (Pilot) Mode as soon as possible. Otherwise, if you lose GPS signal/lock and are not able to properly control Typhoon H in Angle (Pilot) Mode the aircraft may crash or even 'fly away'.

ADDITIONAL FUNCTIONS:

TASK MODES

Tap the TASK/CAMERA icon, the background of 'TASK' will become orange, then you will enter another interface displaying functions: CCC (Curve Cable Cam), Journey, POI (Point of Interest), ORBIT ME and TAKE OFF.



CCC: (Curve Cable Cam) Curve Cable Cam allows you to create an invisible route for Typhoon H to fly along. Once the pilot sets the point, Typhoon H will fly the set coordinates while remembering the heading.

If the PAN mode of the gimbal camera is switched to Follow and Follow Pan Controllable modes, the gimbal TILT angle will be adjusted as the same as the angle what the gimbal camera is at each waypoint after the pilot set the waypoints automatically and continuously. When the PAN mode is switched to the Global Mode, the PAN and TILT angle can be controlled by aileron and elevator stick.

NOTICE: The direct distance between every two waypoint should be more than 5 meters.

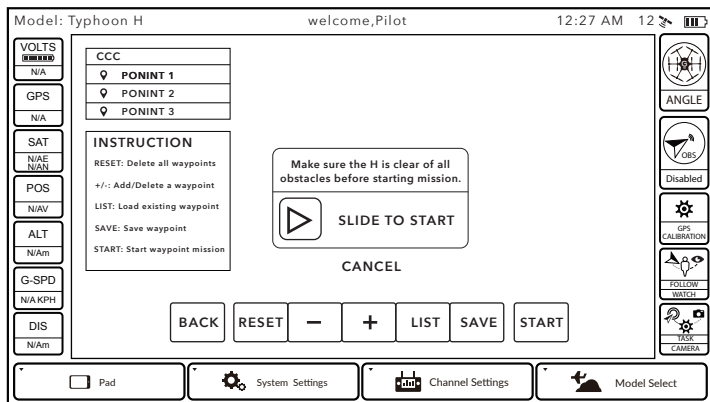

Tap the CCC to enter the Curve Cable Cam function.



BACK: Tap BACK and you can return to the previous interface.

RESET: Tap RESET to delete all the points created during the flight.

- : Tap '-' to delete the last point created during the flight.

+ : Tap '+' to create a new point recording the current flying position.

LIST: Tap LIST and all previous routes saved will be shown on a list. You can delete any saved route by sliding the chosen one to the left.

SAVE: Tap SAVE and the current route will be saved.

START: Tap START, and slide the icon. Typhoon H will fly back to waypoint 1 automatically.

[] : When the pilot tap the [] , the icon will become [▶] and the CCC function will be paused. When tap it again, the [▶] will become [] , the copter will continue the CCC function. The pilot can exit the function by tapping EXIT icon or switching flight mode.

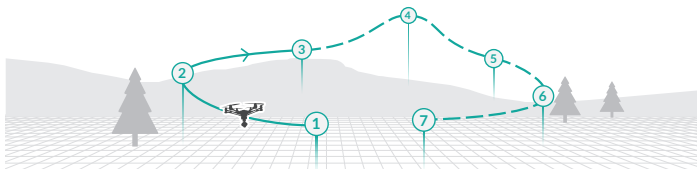

If the pilot set 7 waypoints as shown, when the copter arrives at the Waypoint 1, slowly raise the throttle stick, the copter will fly along the waypoints from 1 to 7 in order. If the pilot slowly lower the throttle stick, the copter will fly along the waypoints from 7 to 1 in order.

NOTICE: Adjust the Throttle Control joystick to change the height of the aircraft, adjust the Aileron Control joystick to change the orbit direction of the aircraft.

JOUR: Journey function enables Typhoon H to capture the perfect aerial selfie or any scenic much easier. Depending on the pilot's desired setting, Typhoon H will go up, out and return.

Tap JOUR to enter the journey function.

START: Select JOUR and set the distance, then slide the slider.. Typhoon H will fly up and out and then take a photo.

BACK: Tap BACK to return to the previous interface.

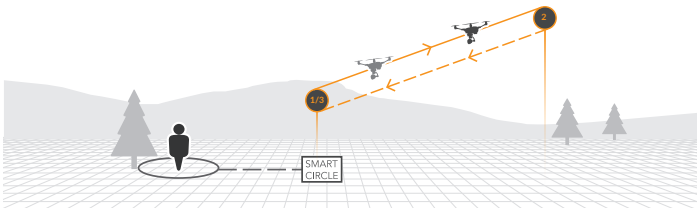

After sliding the icon, the remote control interface will display EXIT and [⏸]. When the pilot tap the [⏸], the icon will become [▶]. Then the journey function is paused. When the pilot taps it again, the [▶] will become [⏸], the copter will continue the journey function. The pilot can exit the function by tapping EXIT icon or switching flight mode.

NOTICE: When the Journey function is activated, the Journey distance can be set by the pilot.

NOTICE: The gimbal camera can't be controlled when journey function is activated and will remain the previous angle set before. Depending on the camera tilt, the aircraft will go up and out to take the perfect selfie.

NOTICE: The journey route is the reverse direction to which the gimbal camera facing towards.

ORBIT ME: When Orbit Me is enabled, Typhoon H flies a circular path around the pilot. Press ORBIT to enter the ORBIT ME function.

START: Press START, and slide the icon, push the aileron stick to the right or left, then Typhoon H will fly around the pilot with the distance between the start point and the pilot as the radius.

BACK: Tap BACK to return to the previous interface.

[⏸]: When the pilot tap the [⏸], the icon will become [▶] and the ORBIT ME function will be paused. When tap it again, the [▶] will become [⏸], the copter will continue the ORBIT ME function. The pilot can exit the function by tapping EXIT icon or switching flight mode.

NOTICE: You can increase/decrease radius by apply forward/back on right stick. You also can trim the gimbal pan position by adjusting pan control knob on ST16.

NOTICE: The tilt direction of gimbal camera can be adjusted by the camera tilt control knob.

NOTICE: If the aircraft flies too close to the pilot, it will automatically enlarge the distance and then begin to orbit.

NOTICE: Adjust the Throttle Control joystick to change the height of the aircraft, adjust the Aileron Control joystick to change the orbit direction of the aircraft.

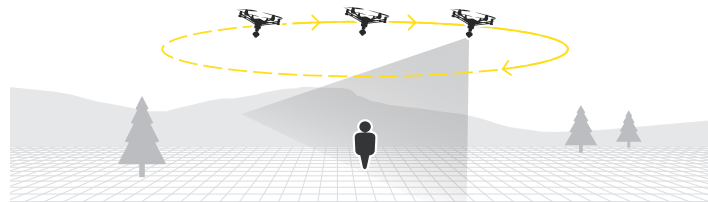

POI: Point of Interest allows the pilot to select a subject they would like to orbit and have Typhoon H orbit that subject autonomously.

CENTER: Press CENTER to set the current flight position of Typhoon H as the center of a circle.

START: Press START, and slide the icon, push the aileron stick to the right or left, Typhoon H will fly around the circle center with distance between the Start point and the center point as the radius.

BACK: Tap BACK to return to the previous interface.

NOTICE: You can increase/decrease radius by apply forward/back on right stick. You also can trim the gimbal pan position by adjusting pan control knob on ST16 (The pilot can refer to ORBIT for camera tilt trimming).

NOTICE: Adjust the Throttle Control joystick to change the height of the aircraft, adjust the Aileron Control joystick to change the orbit direction of the aircraft.

[⏸] When the pilot tap the [⏸], the icon will become [▶] and the POI function will be paused. When tap it again, the [▶] will become [⏸], the copter will continue the POI function. The pilot can exit the function by tapping EXIT icon or switching flight mode.

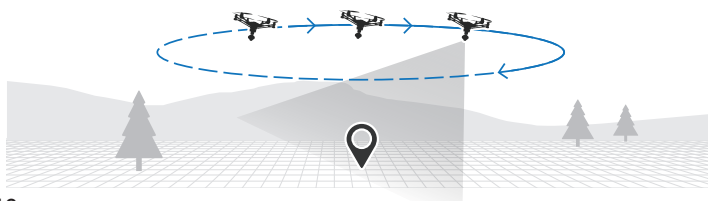

FLIGHT CONTROLS (TEAM MODE)

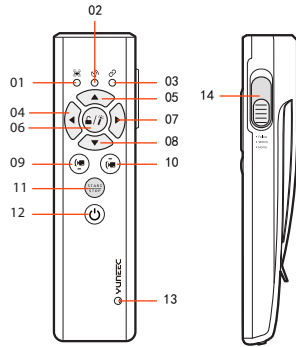

PILOT (WIZARD™)

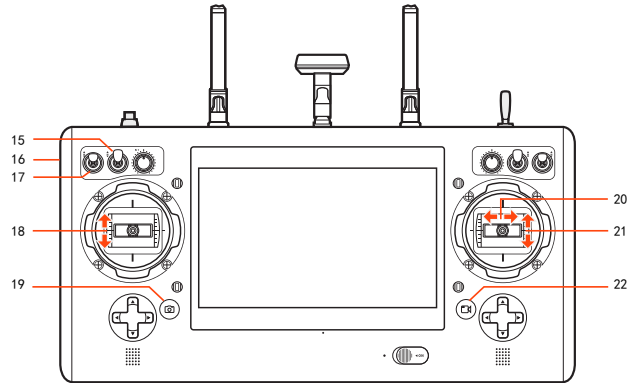

CAMERA OPERATOR (ST16)

- 01 Aircraft Mode LED
- 02 Wizard™ GPS LED
- 03 Aircraft Status LED
- 04 Turn / Fly to the Left Side Button
- 05 Ascend / Forward Button
- 06 Magic Button
- 07 Turn / Fly to the Right Side Button
- 08 Descend / Backward Button
- 09 Tilt Control Button-down (Disabled in team mode)

- 10 Tilt Control Button-up (Disabled in team mode)
- 11 Start / Stop Motors Button
- 12 Wizard™ Power Button
- 13 Wizard™ Power LED
- 14 Smart / Angle / Home Mode Switch
- 15 Pan Mode:
 - Follow (pan can't be controlled)
 - Follow Controllable
 - Global

- 16 Gimbal Tilt Slider in Tilt Angle Mode
- 17 Tilt Mode:
 - Angle/Velocity
- 18 Gimbal Tilt Control in Velocity Mode (Mode 1)
- 19 Take Still Photo Button
- 20 Gimbal Pan Control in Global/ Follow Controllable mode
- 21 Tilt Control in Velocity (mode 2)
- 22 Start/Stop Video Recording Button

TEAM MODE (TWO ST16 Ground Stations)

STEP 1) Switch on the original and the new ST16 Ground Stations first, and then power on Typhoon H. Do not touch it until the initialization completes. Wait a few seconds for the camera to align and all system (RC and video link) connected.

STEP 2) Tap the 'Model' icon on the new ST16 Ground Station, select TYPHOON H, and if required press 'OK' to accept any pop up warnings/alerts.

STEP 3) Tap the System Settings icon [ System Settings] on the new ST16 Ground Station.

STEP 4) Tap the camera settings icon [] on the original ST16, switch from single mode to team mode. When the Typhoon H Main LED Status Indicator starts to blink orange, the aircraft enters binding mode.

STEP 5) Tap the 'Refresh' icon on the new ST16, select the 'SR24_XXXXX' receiver listed in the column under 'Model', and CGO 3P_XXXXX WiFi listed in the column under 'camera', type 'Bind' and enter the password '1234567890' to connect the WiFi, and then tap 'OK' after the connection has been established.

STEP 6) Tap the back button [] once, you will hear two long beeps, which means the binding is successful.

NOTICE: After the binding completes, the original ST16 Ground Station controls the CGO3+ gimbal camera, and the new ST16 Ground Station controls the aircraft.

NOTICE: Under the team mode, the new ST16 can't control the gimbal pan and tilt directions.

IMPORTANT NOTE: The pilot should select 'RealSense Module Installed' in 'Other Settings' row on the ST16 Ground Station first, then the realsense can be activated.

NOTICE: If there is camera error tips after returning back to the controlling interface, you can enter into camera select interface to set and choose the camera type as C-GO3 or C-GO3-PRO, and then tap the return button and return to the main interface.

If you need to switch back to single mode, the operation steps are as follows:

STEP 1: Tap the settings icon [] on the original ST16 and then switch from team mode to single mode.

STEP 2: When the Typhoon H Main LED Status Indicator starts to blink, the aircraft enters binding mode.

STEP 3: Wait for a few seconds, as the remote control will automatically bind to the camera and aircraft. You will hear two beeps from the aircraft when the binding is successful.

TEAM MODE (Wizard™&ST16)

BINDING TYPHOON WIZARD™ TO TYPHOON H

STEP 1) Power on the ST16 Ground Station first, and then switch on Typhoon H. Do not touch it until the initialization completes. Wait a few seconds for the camera to align and all system (RC and video link) connected..

STEP 2) Tap the settings icon [] and then switch from single mode to team mode.

STEP 3) When the Main LED Status Indicator starts to blink orange, the copter enters binding mode.

STEP 4) Press and hold the Power Button of the Wizard until the Aircraft Mode LED glows solid blue. Do not release the Power Button until hearing two beeps from the aircraft, then release it.

NOTICE: When Typhoon H is in team mode (Wizard and ST16), the Wizard must be bound to the copter and the ST16 Ground Station must be bound to the camera. The default mode of Typhoon H is single mode. The ST16 Ground Station comes bound to the copter from the factory and controls both the copter and the CGO3+ Gimbal Camera.

When using the Wizard and ST16 Ground Station in team mode, the Wizard controls the copter and the ST16 Ground Station controls the CGO3+ Gimbal Camera.

If you need to switch back to single mode, the operation steps are as follows:

STEP 1) Tap the settings icon [] on the ST16 and then switch from team mode to single mode.

STEP 2) When the Main LED Status Indicator starts to blink orange, the copter enters binding mode.

STEP 3) Wait for a few seconds, as the remote control will automatically bind to the camera and copter. You will hear two beeps from the aircraft when the binding is successful.

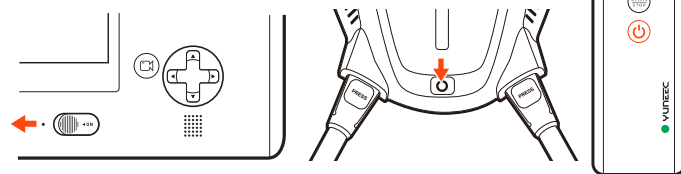

WIZARD BUTTON COMBINATION FUNCTIONS

*All vibrate once when any of the combination function is activated (the Wizard will vibrate twice when turning on the altitude follow function).

*For the last four functions, press the orange marked button first, and then the green one. Release both buttons at the same time after the function is activated.



Turn On/Off altitude follow function
PRESS - Short press
LED ✖ - Blink slowly: Turn off



Switch between Watch Me/ Follow Me function
PRESS - Short press
LED ✖ - ● Watch Me ● Follow Me



Landing gear up/down
PRESS - Short press



Activate point-to-fly function
PRESS - Long press
LED ✖ - Solid blue



Activate compass calibration
PRESS - Long press
 *Turn off WIZARD before pressing this combination buttons.
LED ⚡ - Solid pink



Enter into binding mode
PRESS - Long press
 *Turn off WIZARD before pressing this button.
LED ✖ - Solid blue



Turn on Obstacle Avoidance function
 -Turn off by default
PRESS - Short press
LED ✖ - Blink white and the current mode LED



Turn off Obstacle Avoidance function
PRESS - Short press



Take still photos
PRESS - Short press



Start/stop video record
PRESS - Short press
LED ⚡ - Blink-record start (with the wizard GPS locked)

RETRACTING THE LANDING GEAR

After the copter takes off, the pilot can retract the landing gear by pressing the two buttons [⬅️ ➡️] at the same time. Make sure to press the two buttons at the same time again when landing.

WARNING: Always land as soon as possible after the first low level voltage battery warning, or land immediately after the second level low voltage battery warning by the Motor LED Status Indicators flashing rapidly.



FLIGHT CONTROLS

NOTICE: The safe distance between the Typhoon Wizard™ and the aircraft is 39 ft (12m). The Typhoon Wizard™ can be controlled in different positions. Direction Control Buttons function differently according to the positions of the Wizard™.

1) When the Typhoon Wizard™ is tilted upward between 50° and 90°, the functions of the Direction Control Buttons are as followed:

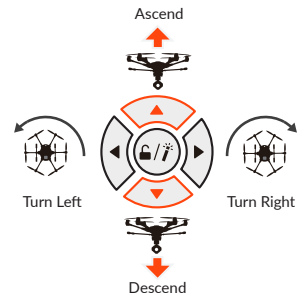
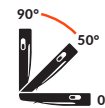

2) When the Typhoon Wizard™ is tilted upward between 0° and 40°, the functions of the Direction Control Buttons are as followed:

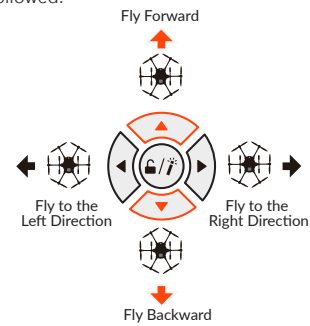
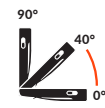

NOTICE: When the aircraft flies to the left or right side, the nose of aircraft doesn't change its direction when the Typhoon Wizard™ is tilted upwards between 0° and 40°.

NOTICE: Press the [▲ ▼] at the same time and the altitude follow function will be turned On/Off. Press the [⬅️ ➡️] at the same time and the Watch Me/Follow Me function can be freely switched.

'POINT TO FLY' FUNCTION

Press and hold the Magic Button on the Typhoon Wizard™, and the aircraft will fly in the direction the Typhoon Wizard™ is pointed to in the sky.

To Enter 'Point To Fly' Function

When the aircraft is flying, point the Typhoon Wizard™ to a direction, press and hold the Magic Button. Release the Magic Button when Aircraft Mode LED glows solid blue and Typhoon Wizard™ vibrates once. Then the aircraft will fly to the direction the Typhoon Wizard™ points. The closer the Typhoon Wizard™ is tilted towards 0°, the further the aircraft will fly away from the pilot (refer to the orange flight track below). The closer the TYPHOON Wizard™ is tilted towards 90°, the closer the aircraft will fly to the pilot (refer to the blue flight track below). When the Wizard™ is tilted at 90°, the aircraft will fly close to you straightly and stop at a safe distance (refer to the black flight track below).

● ● ● Wizard™ Pointing Direction

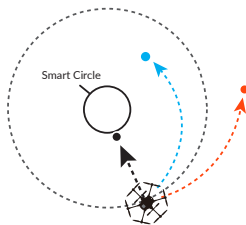

NOTICE: The recommended flying height is 33-66 ft (10-20 m). The operating distance range of the Typhoon Wizard™ is 33-164 ft (10-50 m).

To Exit 'Point To Fly' Function

When in the 'Point To Fly' Function, press any Direction Control Button to exit this function. The aircraft will stop moving and automatically hold its position (with a suitable GPS signal/lock) and maintain a level attitude then.

FLIGHT MODES

SMART MODE

When the Flight Mode Selection Switch is in the top position, the aircraft will be in the Smart Mode. The Aircraft Mode LED on the Wizard™ will glow solid green.

1) Watch Me Function Under Smart Mode

Watch Me function enables the camera to keep tracking the Typhoon Wizard™ no matter where and how it moves as the camera can automatically tilt its angle according to the Wizard™. It is "watch me" mode if both the LEDs for Aircraft Mode and Wizard™ GPS are green.

Usually, the default function under the Smart Mode is Watch Me when using the Wizard.

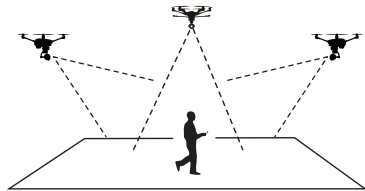

The pilot will always be kept in the frame wherever he/she moves.

NOTICE: In the Smart Mode, the geo-fence will keep the aircraft from traveling further than 295 ft (90 m). The geo-fence is a virtual 'barrier'.

CAUTION: Any operation related to camera exposure setting control needs to be done on mobile APPs or ST16. The APP can be downloaded from Google Play Store or APP Store. You can also use the Wizard™ to take photos or record videos.

IMPORTANT NOTE: The 'Point To Fly' Function can only be activated in Smart Mode.

IMPORTANT NOTE: In the team mode, the gimbal camera is controlled by the ST16 Ground Station. The gimbal camera is not able to point to the pilot automatically, and the tilt direction can't be controlled, either. If the pilot needs to activate Watch Me function by using the Wizard, he or she can bind the Wizard and the aircraft. Then the ST16 can't bind the gimbal camera in the team mode.

- Binding ONLY the Wizard with the aircraft:

STEP 1) Turn off the ST16 Ground Station and Wizard, turn on the aircraft.

STEP 2) Lean the aircraft in the forward direction twice (45°), until the Main LED indicator blinks orange rapidly.

STEP 3) Press and hold the power button of the Wizard, until the Aircraft Mode LED is solid blue.

STEP 4) Release the power button of the Wizard when hearing two beeps.

2) Follow Me Function Under Smart Mode

The Follow Me function allows the aircraft to follow the pilot, adjusting its location to the location of the Typhoon Wizard™. All buttons are controllable in this mode. When in Follow Me, the aircraft will follow the movement of the Typhoon Wizard™ if there is no extra operation on the Typhoon Wizard™.

Follow Me function can be switched to by the following steps:

When in Smart Mode, Press the [◀ ▶] at the same time quickly once, it is "follow me" model if Aircraft Mode LED on the Wizard™ is yellow and Wizard™ GPS LED is green.

NOTICE: Press the [▲ ▼] buttons at the same time quickly once to turn on the height following function, then the aircraft will change its height according to the pilot.

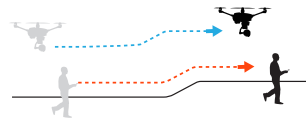

WARNING: The maximum flight speed of the Typhoon H aircraft is 36.9MPH (16.5m/s). If the movement of the pilot is much faster than 36.9MPH (16.5m/s), the aircraft may fly away.

WARNING: After realense is turned on, the speed of the aircraft will be limited to 11.2MPH (5m/s). If the pilot moves too fast, the distance between the aircraft and the Wizard might be enlarged.

IMPORTANT NOTE: Crash is NOT covered under warranty.

ANGLE MODE

When the Flight Mode Selection Switch is in the middle position, the aircraft will be in Angle Mode. When Angle Mode is enabled, the Aircraft Mode LED on the Wizard™ will glow solid purple.

In this mode, the aircraft will move in the direction the Typhoon Wizard™ is controlled relative to the front/nose of the aircraft. The aircraft has no function of Follow Me or Watch Me.

NOTICE: In this mode, the 'Point To Fly' Function can't be activated.

IMPORTANT NOTICE: In Angle Mode, it is not suggested travelling further than 656 ft (200 m). The Wizard™ will keep vibrating when the aircraft travels further than 656 ft (200 m).

HOME MODE

When the Flight Mode Selection Switch is in the bottom position, the aircraft will be in the Home Mode. The Aircraft Mode LED will be solid red. To exit the Home Mode, switch the Mode Switch to Angle/Smart Mode, then the aircraft will stop moving and automatically hold its position (with a suitable GPS signal/lock) and maintain a level attitude then.

In Home Mode (with realsense turned off) the aircraft will fly in a straight line in the direction of the pilots' current location, and automatically land within 13-26 ft (4-8 m) of the pilot.

NOTICE: In this mode, the 'Point To Fly' Function can't be activated.

CAUTION: Don't switch to Home Mode when you are near bodies of water.

NOTICE: When Home mode is activated by the Wizard, the aircraft will land slowly automatically. Pilots can hold the Wizard upwards to 90° and long press the [▼] to accelerate the landing speed.

NOTICE: In Home Mode, the aircraft will avoid the obstacle automatically with realsense turned on when flying back to home point. The speed will be limited.

CAMERA CONTROLS

SINGLE MODE

GIMBAL CAMERA TILT CONTROL

There is a gimbal tilt mode switch on ST16---S1. When the switch is in up/middle position, the CGO3+ gimbal camera is in Angle Mode. Use the slider (C) on the left side of the ST16 to set the tilt position of the gimbal camera. When the S1 is in bottom position, the gimbal camera is in Velocity Mode. When the slider (C) is in the middle position, it means the velocity rate is 0 for the CGO3+, and it will stop tilting up/down.

When the slider (C) is above the middle position, the CGO3+ will start tilting up. When the slider (C) is below the middle position, the CGO3+ will start tilting down. The distance between the slider(C) and the middle position decides the velocity rate, the further distance, the higher velocity it would be.

CAUTION: You MUST stop recording video in order to take still photos. It will take approximately 1-2 seconds to capture a still photo and before you can take another.

CAUTION: ALWAYS stop recording video before turning off Typhoon H to avoid data loss.

NOTICE: Only in the velocity mode, the camera can tilt upwards 15° maximum.

Button A = Take Still Photo Button B = Start/Stop Recording Video

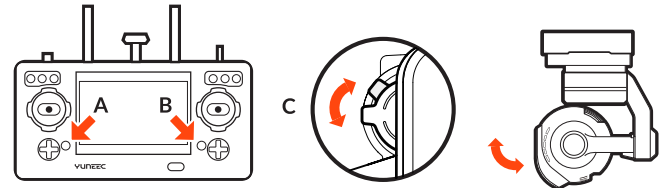

NOTICE: After the pilot switch from video mode (Camera type C-GO3-Pro) to take photo mode, the pilot can activate the function of long exposure for four seconds.

GIMBAL CAMERA PAN CONTROL

There is a gimbal pan mode switch on ST16---S2. When the switch position is up, the gimbal camera is in Follow Mode. The pan control of the gimbal camera is now disabled. The gimbal camera will adjust its pan direction according to the aircraft's movements. When the switch is in the middle position, the gimbal camera is in Follow Pan Controllable Mode, the gimbal camera will adjust its pan direction according to the aircraft's movements. Meanwhile, the pan control is activated, use the Pan Control Knob to set the pan position of the gimbal camera. When the switch position is down, the gimbal camera is in Global Mode. The pan direction of the gimbal camera will be fixed regardless of the aircraft's movements. Use the Pan Control Knob to set the pan position of the gimbal camera.

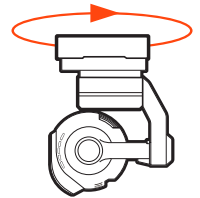

TEAM MODE

GIMBAL CAMERA TILT CONTROL

There is a gimbal tilt mode switch on ST16---S1. When the switch is in up/middle position, the CGO3+ gimbal camera is in Angle Mode. Use the slider (C) on the left side of the ST16 to set the tilt position of the gimbal camera. When the S1 is in bottom position, the gimbal camera is in Velocity Mode. When the Elevator joystick is in the middle position, it means the velocity rate is 0 for the CGO3+, and it will stop tilting up/down. When the Elevator joystick is above the middle position, the CGO3+ will start tilting up. When the Elevator joystick is below the middle position, the CGO3+ will start tilting down. The distance between the Elevator joystick and the middle position decides the velocity rate, the further distance, the higher velocity it would be.

NOTICE: Only in the velocity mode, the camera can tilt upwards 15° maximum.

NOTICE: After the pilot switch from video mode to take photo mode, the pilot can activate the function of long exposure for four seconds (Camera type C-GO3-Pro).

GIMBAL CAMERA PAN CONTROL

There is a gimbal pan mode switch on ST16---S2. When the switch position is up, the gimbal camera is in Follow Mode. The pan control of the gimbal camera is now disabled. The gimbal camera will adjust its pan direction according to the aircraft's movements. When the switch is in the middle position, the gimbal camera is in Follow Pan Controllable Mode, the gimbal camera will adjust its pan direction according to the aircraft's movements. Meanwhile, the pan control is activated, use the aileron joystick to set the pan position of the gimbal camera. When the switch position is down, the gimbal camera is in Global Mode. The pan direction of the gimbal camera will be fixed regardless of the aircraft's movements. Use the aileron joystick to set the pan position of the gimbal camera.

TAKING PHOTOS AND RECORDING VIDEO

The ST16 seamlessly integrates control of the CGO3+ so you can easily take still photos and start/stop video recording using the corresponding buttons located on the face.

To Take A Still Photo

Press the button located near the bottom left corner of the ST16. You'll hear an audible 'shutter' sound from the ST16 and the LED indicator on the front of the CGO3+ will blink blue and green alternatively once. It will take approximately 1-2 seconds to capture the photo and before you can take another still photo.

To START/STOP Recording Video

Press the button located near the bottom right corner of the ST16. You'll hear an audible indication from the ST16 each time the recording starts/stops. And while video is recording the LED indicator on the front of the CGO3+ will flash blue and green, and there will be a red dot next to the time length of the recording on the screen of the ST16.

NOTICE: C-GO3-Pro camera is the default selection in ST16. You can take still photos in the video recording mode. The resolution is set by the video resolution.

CAUTION: Do not change settings when aircraft is further than 1,000 feet from ST16.

fusers are professionals in photography and videography, and want to adjust manual settings, please follow the steps below:



STEP 1) Press System Settings, choose Camera Select, press C-GO3-Pro, press Select, and press OK.

STEP 2) The second left column is available for adjusting the camera settings, like white balance, exposure, shutter speed and ISO, etc.

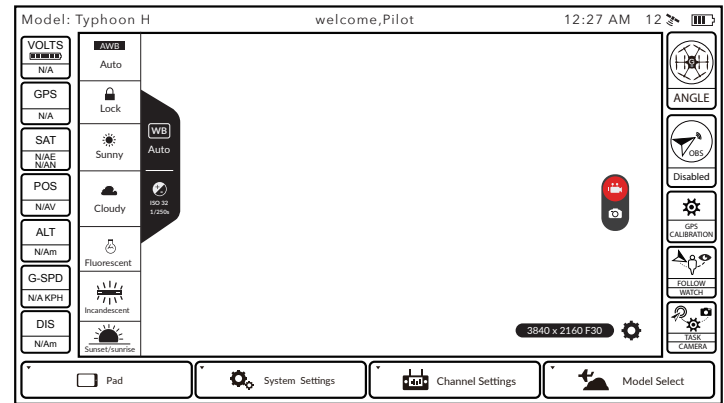

STEP 3) Press camera setting button in the Video Mode, different video resolutions are available.



CAMERA PARAMETER SETTING

In the [] menu, the user can choose different mode based on the situation. The camera will adjust parameter according to the light automatically when tapping []. When tapping the button [], the parameter at that time will be locked.

In the [] menu, the exposure or shutter speed and iso can be adjusted manually or automatically.

NOTICE: Tap the icon [] and you can press the Auto [] to change it to M [], which means you can adjust the shutter speed and ISO manually.

NOTICE: In the taking-picture mode, the resolution is 12,400,000. In the video recording mode, resolution needs to be applied when taking pictures.

CAUTION: ALWAYS stop recording video before turning off Typhoon H/CGO3+ to avoid data loss. If you accidentally turn off Typhoon H/CGO3+ before you stop recording, re-insert the micro SD card (if removed) and turn the system on again. Wait until the camera LED starts to glow solid green indicating the last video file was recovered.

CAUTION: When entering the photo capturing mode, video recording is disabled. You MUST switch to video recording to start recording videos. In the video recording mode, picture taking (Button A) is accessible. The resolution is set by the video resolution. In this mode, you will capture still photos.

GPS FUNCTIONALITY

When flying outdoor, Typhoon H requires a suitable GPS signal/lock in order to start the motors and to be flown. please operated in open areas that are free from people, vehicles and other obstructions. In order to acquire a suitable GPS signal/lock it's critical that the GPS antenna installed in the top of Typhoon H always have a clear view of the sky (100° minimum clearance required).

NOTICE: if the flight control activate the IPS indoor, the Main LED indicator of the aircraft will be solid purple, then you can start the motors.

NOTICE: When using IPS without GPS locked, make sure that the indoor illumination is sufficient. The IPS may not function well when the aircraft is flying over highly reflective surfaces or over highly repeated surface texture (such as the same color).

NOTICE: When flying indoor with IPS, OBS Avoid, Smart Mode and Home Mode are disabled.

WARNING: When using GPS outdoor, do NOT attempt to fly near or between tall buildings/obstructions, near or under dense vegetation,

structures. Do NOT attempt to fly in any location known to have poor GPS coverage. Do NOT disable/turn off GPS unless you're able to properly control Typhoon H in Angle (Pilot) Mode without GPS or IPS assistance and accept ALL responsibility and liability for crashes or 'fly aways'.

If the Typhoon loses GPS signal/lock while flying high in the sky it can only be flown in Angle (Pilot) Mode, Smart Mode, OBS AVOID and Home Mode, along with their corresponding features, will no longer work. The Main LED Status Indicator will flash purple and the LED Status Indicators below the motors will flash three times per second then will stay off for one (1) second when the Typhoon loses GPS signal/lock (or if GPS has been disabled/turned off).

If the GPS signal/lock is reacquired (after receiving 5-10 seconds of suitable GPS signal), Smart Mode and Home Mode will work again.

WARNING: Loss of GPS signal/lock may result in a crash or even a 'fly away'.

IMPORTANT NOTE: Crash damage and 'fly aways' are NOT covered under warranty.

NO-FLY ZONES

With a suitable GPS signal/lock it will not be possible to start the motors, takeoff or fly Typhoon H in the 'No-Fly Zones' within a 4 mile (6.4 kilometer) radius of most major airports.

NOTICE: If the aircraft flies near the ground and lost GPS signal, the IPS may assist aircraft to fly. After IPS is on, the LED will be solid purple, and OBS AVOID, Smart Mode and Home Mode are disabled.

DISABLING GPS

WARNING: Smart Mode and Home Mode, along with their corresponding features, only work when GPS is active and Typhoon H has a suitable GPS signal/lock. If you disable/turn off GPS, Typhoon H can only be flown in Angle (Pilot) Mode. If you cannot properly control the Typhoon in Angle (Pilot) Mode, the aircraft may crash or even 'fly away'.

NOTICE: IPS will be turned off when GPS is turned off, do not turn off GPS when the pilot needs IPS to fly indoor.

IMPORTANT NOTE: Crash damage and 'fly aways' are NOT covered under warranty.

We do not typically recommend disabling GPS for any reason, especially if you're a first-time or low-time pilot. However, if you're an experienced pilot that's able to properly control Typhoon H in Angle (Pilot) Mode, you can disable/turn off GPS. Do NOT disable/turn off GPS unless you accept ALL responsibility and liability for crashes or

'fly always'.

IMPORTANT NOTE: Every time you turn on Typhoon H, it will default to having GPS active/on (even if you disabled GPS the last time it was powered on).

After the ST16 Ground Station and the CGO3+ are bound successfully, press the GPS Calibration icon, and then tap the GPS Switch to turn off the GPS.

CREATE A NEW MODEL

PREPARING THE ST16

STEP 1) Switch on the ST16 Ground Station, then tap 'Model Select', and if required press 'OK' to accept any pop up warnings/alerts. Tap the 'Bind' button.

STEP 2) Tap the new model and select the 'Create Model', then choose 'Type', select the 'TYPHOON H'

STEP 3) Input the model name and tap the above icon []

STEP 4) Select the TYPHOON H photo, then tap 'Save'.

STEP 5) Enter the newly created model, then tap the 'System Setting'.

BINDING THE TYPHOON H

STEP 1) Switch on the aircraft and wait till all the initialization completes.

STEP 2) Lean the TYPHOON H in the forward direction twice (45°) until the Main LED indicator blinks orange rapidly.

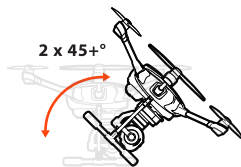

STEP 3) Tap the 'Refresh' button on the screen.

STEP 4) Select the 'SR24_XXXXX' receiver listed in the column under 'Model', and CGO 3P_XXXXX WiFi listed in the column under 'camera' on the ST16 Ground Station. Typing 'Bind' then enter the password '1234567890' to connect the WiFi, and then tap 'OK' after the connection has been established.

STEP 5) Tap the 'Back' button to return to the main screen and you will hear two long beeps. The flight data will show on the screen.

NOTICE: You can also copy a model to bind a new aircraft by long press the original model icon and tap 'Copy'. Then repeat the above steps.

NOTICE: If there is an error tip about camera mode, tap OK and it will enter into camera mode choose interface automatically. Select C-GO3 or C-GO3-Pro, and then press return button to return back to controlling interface.

GUI INSTRUCTION

CAUTION: Remove all the propellers before using the GUI.

STEP 1) Download the TYPHOON H GUI setup on our official website: www.yuneec.com

STEP 2) Unpack and install the file.

STEP 3) Double click the icon []

STEP 4) Switch off the ST16 Ground Station. Power on the TYPHOON H and use the USB cable to connect the aircraft and computer. The interface will display the sensor information automatically, and you will see all the data on the screen.

FUNCTION 1:

Speed Controller Status and Testing

STEP 1) Click the 'Enable Testing', then click 'I have removed the propellers, and it's safe to enable motor testing', tap 'YES'.

STEP 2) All the motors will turn red in the top right corner on the interface. Move your mouse on the propeller which you want to spin, and click it, then the motor will spin.

NOTICE: If you hold and press it, the motor will spin continuously. You can also click the 'ALL TURN' button to spin all the motors at the same time.

FUNCTION 2:

Settings

The Geo-fence and Height limit can be redefined by adjusting the data in the 'New Value' column, then you can write the new data in the flight control by clicking the 'Update' button.

NOTICE: Although the data can be changed by the pilot, we recommend to keep the default settings.

FUNCTION 3:

GPS Information

You can check the Signal Strength and the Available Satellites by the graph, and more detailed information below the graph.

FUNCTION 4:

Device Information

You can get the information about the GUI version, firmware and Vehicle type and ID.

NOTICE: When the aircraft is connected with the computer, you can't switch off the aircraft.

CALIBRATION

COMPASS CALIBRATION

CAUTION: Do not calibrate the compass in parking garages, close to buildings or near roads with a metal core. For optimum performance, only calibrate Typhoon H in open spaces, far away from power lines and other metal structures or concrete buildings.

NOTICE: Be sure to perform the compass calibration procedure at least 11 feet away from the nearest cell phone or other electronic devices to ensure proper calibration.



STEP 1) Power on the ST16 Ground Station first and then the aircraft, and make sure they are connected correctly. If they are not connected correctly, the telemetry data will not display on the screen.

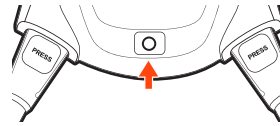
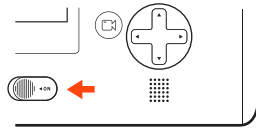

STEP 2) Tap the GPS CALIBRATION icon on the ST16 screen and choose COMPASS.

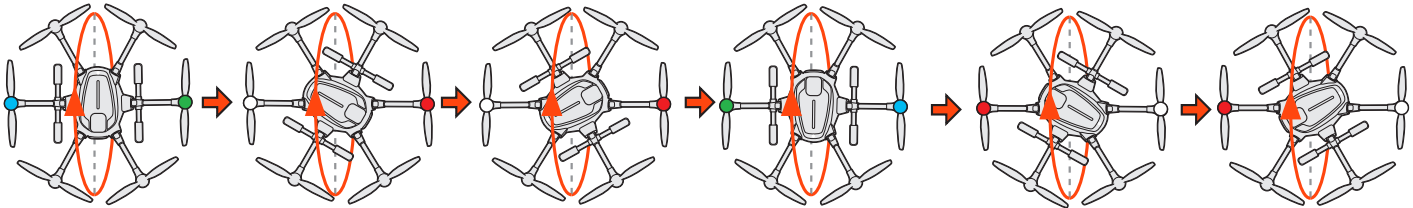

STEP 3) Lift Typhoon H airframe straight & level. When the LEDs on two motors start to blink blue and green separately as illustrated, turn it forward as shown by the red arrow above until the two LEDs turn off.

STEP 4) When the LEDs on another two motors start to blink white and red separately as illustrated, turn the aircraft 60° to the left and then turn it forward as shown by the red arrow above until the two LEDs turn off.

STEP 5) When the LEDs on another two motors start to blink white and red separately, Turn the aircraft 60° to the left again and then turn it forward as shown by the red arrow above until the two LEDs turn off.

STEP 6) When the LEDs on another two motors start to blink green and blue separately, Turn the aircraft 60° to the left again and then turn it forward as shown by the red arrow above until the two LEDs turn off.

STEP 7) When the LEDs on another two motors start to blink red and white separately, Turn the aircraft 60° to the left again and then turn it forward as shown by the red arrow above until the two LEDs turn off.

STEP 8) When the LEDs on another two motors start to blink red and white separately, Turn the aircraft 60° to the left again and then turn it forward as shown by the red arrow above until the two LEDs turn off.

If the calibration has been successful, all the LED status indicators will blink continuously, the Main LED Status Indicator will be solid green and the flight controller restarts, you will recognize this when you hear the acknowledgement tone, the same one you hear when you switch the system on.

IMPORTANT NOTE: If calibration has failed, the Main LED Status Indicator will be solid white and you must repeat the calibration process. If the calibration continues to fail, either the site of calibration is unsuitable or the compass is defective. Refer to your Yuneec service center.

GIMBAL CAMERA CALIBRATION

STEP 1) Place the TYPHOON H on a level and stable surface. Switch on the ST16 Ground Station and the aircraft and wait till the RC and WiFi connected.

STEP 2) Make sure the tilt mode and pan mode all switched upwards, then tap the 'GPS Calibration' button and choose the 'GIMBAL CALIBRATION'.

STEP 3) The Gimbal camera will calibrate itself automatically. Wait the gimbal camera align in 3 axis and stay still, which means the gimbal calibration completes.

NOTICE: The whole calibration will take about 2-3 minutes. During the calibration process, do not touch or move the aircraft.

ACCELEROMETER CALIBRATION

STEP 1) Place the TYPHOON H on a level and stable surface. Switch on the ST16 Ground Station and the aircraft and wait till the RC and WiFi connected.

STEP 2) Make sure the FLIGHT MODE switch is in the middle position. Tap the GPS Calibration button, and choose 'ACCELEROMETER'.

STEP 3) Keep the aircraft hovering during the calibration process. During calibration, the main led will blink red, green and blue slowly at first and start the motors and take off the aircraft, then the LED will blink rapidly afterwards. When the LED blinks slowly, land and aircraft and stop the motors. If calibration succeed. The copter will restart automatically. You will recognize the this when you hear the raising tone.

NOTICE: You must do the accelerometer calibration in no-wind condition.

IMPORTANT NOTE: If calibration has failed, the Main LED Status Indicator will be solid white and you must repeat the calibration process. If the calibration continues to fail, either the site of calibration is unsuitable or the accelerometer is defective. Refer to your Yuneec service center.

UPDATE

UPDATE THE ST16 GROUND STATION

STEP 1) Download the Firmware update document and unpack it. Copy the firmware document into the Micro SD card.

STEP 2) Plug the Micro SD card into the ST16 Ground Station, and switch on the Ground Station.

STEP 3) Tap the 'System Settings' , and if required press 'OK' to accept any pop up warnings/alerts.

STEP 4) Tap the 'About Controller' and press the 'UPDATE' in the ST16 column, and it will update automatically.

NOTICE: When the update process completes, the ST 16 Ground Station will restart automatically.

NOTICE: Make sure the ST16 is fully charged to complete the upgrade process.

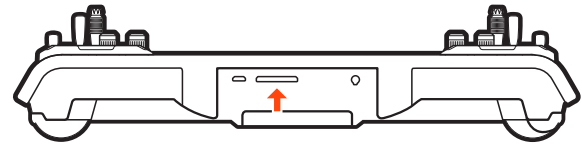

UPDATE THE TYPHOON H AIRCRAFT

STEP 1) Download the Firmware update document and unpack it. Copy the firmware document into the Micro SD card.

STEP 2) Plug the Micro SD card into the CGO3+, and switch on the ST16 Ground station and the TYPHOON H.

STEP 3) Wait all the connections are established. Tap the 'System Settings' , and if required press 'OK' to accept any pop up warnings/alerts.

STEP 4) Tap the 'About Controller' and press the 'UPDATE' in the TYPHOON H column, and it will update automatically.

NOTICE: When the update process completes, the ST 16 Ground Station will pop up tips to restart the TYPHOON H manually.

LED STATUS INDICATIONS

LED STATUS INDICATIONS DURING STARTUP

Main LED Status Indicator

- Initialization failed
 - The Aircraft is in "Bind" Mode
 - The Aircraft is in a No-Fly Zone *
- * Please see the instruction manual for more information regarding no-fly zones

- Pulses red (3 times per second)
- Blinks orange very rapidly (10 times per second)
- Blinks red and white rapidly (5 times per second)

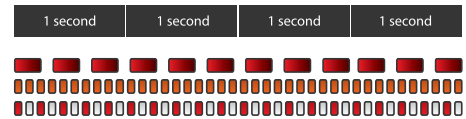

LED STATUS INDICATIONS BEFORE/DURING FLIGHT

Main LED Status Indicator

- The Aircraft is in Smart Mode with GPS lock
- The Aircraft is in Smart Mode without GPS lock
- The Aircraft is in Angle Mode with GPS lock or IPS
- The Aircraft is in Angle Mode without GPS lock or IPS
- The Aircraft is in Home Mode
- Enter Task function
- First Level low Voltage Battery Warning
- Second Level low Voltage Battery Warning
- GPS Disabled

- Glows solid green
- Blinks green (3 times per second) then off (for 1 second)
- Glows solid purple
- Blinks purple (3 times per second) then off (for 1 second)
- Blinks red rapidly (5 times per second)
- Blink green and purple slowly (1 time per second)
- Blinks red, green and blue every 3 seconds
- Blinks red, green and blue continuously
- Blinks purple (1 flash per second)

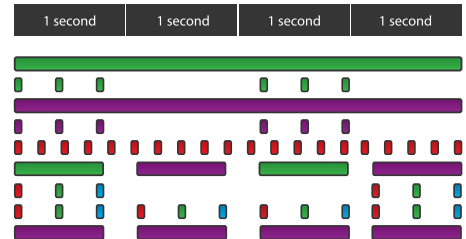

NOTICE: White blink between solid flight mode indicates enough satellites for Watch Me/Follow Me.

Below Motor Led Status Indicators

- Low voltage battery warning

- Blinks rapidly (5 times per second)

LED STATUS INDICATIONS FOR CALIBRATION MODES

Main LED Status Indicator

- Compass Calibration Mode Entered
- Compass Calibration Started
- Accelerometer Calibration Mode Entered
- Accelerometer Calibration started
- Calibration failed

- Blinks red and green slowly (2 times per second)
- Blinks red and green rapidly (5 times per second)
- Blinks red, green and blue slowly (1 time per second)
- Blinks red, green and blue rapidly (3 times per second)
- Glows solid white

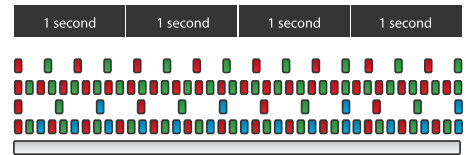

CGO3+ CAMERA LED STATUS INDICATIONS

- Without T-card or T-card Memory Full
- WiFi Error
- WiFi Initialized
- WiFi Connected
- Recording Video or Taking Still Photos

- Blinks yellow
- Blinks red
- Blinks green
- Glows solid green
- Blinks green, blue slowly

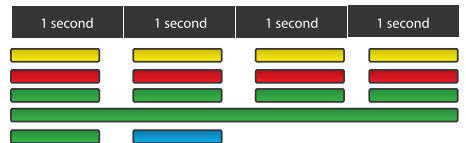

Wizard™ LED STATUS

Aircraft Mode LED

- Smart Mode: LED solid green
- Watch Me Function: LED solid green
- Follow Me Function: LED solid yellow
- Angle Mode: LED solid purple
- Home Mode: LED solid red
- 'Point To Fly' Function Activated: LED solid blue
- ☆ Obs. Avoidance On: LED blink white
- Altitude follow function turned off: LED blinking slowly

Wizard™ GPS LED

- GPS Locked: LED solid green.
- ✱ Recording video: LED blinking green once every second (with the Wizard GPS locked)

Aircraft Status LED

- The Communication Mal-function Between the Wizard™ and the Aircraft: LED solid red
- GPS Loss of Aircraft: LED off
- ✱ Aircraft in No-Fly Zone: LED blinking red, green and blue alternately
- Battery full: LED solid green
- ✱ Battery 50%: LED blinking green twice every 2 seconds
- ✱ Battery 25%: LED blinking green once every 2 seconds
- ✱ Low Voltage Warning of the Aircraft: LED blinking red quickly, the Wizard™ vibrating for 2 seconds once continuously

Wizard™ Power LED:

- Powered On: LED solid green
- During Charging: LED solid red
- Charging Completed: Red LED off
- Low Voltage Warning of the Wizard™:
 - ✱ Battery 50%--- LED blinking green twice every 2 seconds
 - ✱ Battery 25%--- LED blinking green once every 2 seconds
 - ✱ Power Cut-off---LED blinking red quickly, the Wizard™ vibrating for 2 seconds once continuously.

NOTICES AND WARNINGS

IMPORTANT NOTE: All safety precautions and warnings, instructions, warranties and other collateral information is subject to change at the sole discretion of Yuneec. For the most up-to-date information please visit the corresponding product page at www.Yuneec.com or contact the nearest Yuneec office or authorized distributor.

The following special language terms are used throughout the product literature to indicate various levels of potential harm when operating this product:

NOTICE: Procedures, which if not properly followed, create a possibility of property damage and/or possibility of injury.

WARNING: Procedures, which if not properly followed, create the probability of property damage, collateral damage and/or serious injury or create a high probability of superficial injury.

WARNING: Read the ENTIRE quick start guide and instruction manual to become familiar with the features of the product before operating. Failure to operate the product correctly can result in damage to the product, property and/or cause serious injury.

WARNING: This is a sophisticated consumer product. It must be operated with caution and common sense, and requires some basic mechanical ability.

Failure to operate this product in a safe and responsible manner could result in damage to the product, property and/or cause serious injury. This product is not intended for use by children without direct adult supervision. Do not use with incompatible components or alter this product in any way outside of the instructions provided by Yuneec. The quick start guide and instruction manual contain instructions for safety, operation and maintenance. It is essential to read and follow all the instructions and warnings prior to assembly, setup and/or use in order to operate the product correctly and avoid damage or serious injury.

AGE RECOMMENDATION: NOT FOR CHILDREN UNDER 14 YEARS. THIS IS NOT A TOY.

GENERAL SAFETY PRECAUTIONS AND WARNINGS

WARNING: Failure to use this product in the intended manner as described in the quick start guide and instruction manual can result in damage to the product, property and/or cause serious injury. A Radio Controlled (RC) multirotor aircraft, APV platform, drone, etc. is not a toy! If misused it can cause serious bodily harm and damage to property.

WARNING: As the user of this product you are solely and entirely responsible for operating it in a manner that does not endanger yourself and others or result in damage to the product or the property of others.

- Keep your hands, face and other parts of your body away from the spinning propellers/rotor blades and other moving parts at all times. Keep items that could impact or become entangled away from the propellers/rotor blades including debris, parts, tools, loose clothing, etc.
- Always operate your aircraft in open areas that are free from people, vehicles and other obstructions. Never fly near or above crowds, airports or buildings.
- To ensure proper operation and safe flight performance never attempt to operate your aircraft nearby buildings or other obstructions that do not offer a clear view of the sky and can restrict GPS reception.
- Do not attempt to operate your aircraft in areas with potential magnetic and/or radio interference including areas nearby broadcast towers, power transmission stations, high voltage power lines, electrical storms, etc.
- Always keep a safe distance in all directions around your aircraft to avoid collisions and/or injury. This aircraft is controlled by a radio signal subject to interference from many sources outside your control. Interference can cause momentary loss of control.
- To ensure proper and safe operation of the automatic landing function in Home Mode you must start the motors with the aircraft in a position that has at least 10 feet (approximately 3 meters) of clear and open space around it and achieve a proper GPS lock.
- Do not attempt to operate your aircraft with any worn and/or damaged components, parts, etc. (including, but not limited to, damaged propellers/rotor blades, old batteries, etc.).
- Never operate your aircraft in poor or severe weather conditions including heavy winds, precipitation, lightning, etc.
- Always operate your aircraft starting with a fully charged battery. Always land as soon as possible after the first level low voltage battery warning or land immediately after the second level low voltage battery warning (as indicated by the vibrations and audible alerts from the transmitter/personal ground station).
- Always operate your aircraft when the voltage of the battery in the transmitter/personal ground station is in a safe range (as indicated by the battery charge status icon on the screen of the transmitter/personal ground station).
- Always keep the aircraft in clear line of sight and under control, and keep the transmitter/personal ground station powered on while the aircraft is powered on.
- Always move the throttle control stick down fully and turn off the motors in the event the propellers/rotor blades come into contact with any objects.
- Always allow components and parts to cool after use before touching them and flying again.
- Always remove batteries after use and store/transport them per the corresponding guidelines.
- Avoid water exposure to all electronic components, parts, etc. not specifically designed and protected for use in water. Moisture causes damage to electronic components and parts.
- Never place any portion of the aircraft or any related accessories, components or parts in your mouth as doing so could cause serious injury or even death.
- Always keep chemicals, small parts and electronic components out of the reach of children.
- Carefully follow the instructions and warnings included with this aircraft and any related accessories, components or parts (including, but not limited to, chargers, rechargeable batteries, etc.).

CAUTION: The electronic speed controls (ESCs) installed in the TORNADO are not compatible with any other product, and the TORNADO is not compatible with any other ESCs. Use of any other ESCs in the TORNADO will cause a crash, which may result in damage to the product, property and/or cause serious injury.

LIPO BATTERY WARNINGS AND USAGE GUIDELINES

WARNING: Lithium Polymer (LiPo) batteries are significantly more volatile than alkaline, NiCd or NiMH batteries. All instructions and warnings must be followed exactly to prevent property damage and/or serious injury as the mishandling of LiPo batteries can result in fire. By handling, charging or using the included LiPo battery you assume all risks associated with LiPo batteries. If you do not agree with these conditions please return the complete product in new, unused condition to the place of purchase immediately.

- You must always charge the LiPo battery in a safe, well-ventilated area away from flammable materials.
- Never charge the LiPo battery unattended at any time. When charging the battery you must always remain in constant observation to monitor the charging process and react immediately to any potential problems that may occur.
- After flying/discharging the LiPo battery you must allow it to cool to ambient/room temperature before recharging.
- To charge the LiPo battery you must use only the included charger or a suitably compatible LiPo battery charger. Failure to do so may result in a fire causing property damage and/or serious injury.
- If at any time the LiPo battery begins to balloon or swell, discontinue charging or discharging immediately. Quickly and safely disconnect the battery, then place it in a safe, open area away from flammable materials to observe it for at least 15 minutes. Continuing to charge or discharge a battery that has begun to balloon or swell can result in a fire. A battery that has ballooned or swollen even a small amount must be removed from service completely.
- Do not over-discharge the LiPo battery. Discharging the battery too low can cause damage to the battery resulting in reduced power, flight duration or failure of the battery entirely. LiPo cells should not be discharged to below 3.0V each under load.
- Store the LiPo battery at room temperature and in a dry area for best results.
- When charging, transporting or temporarily storing the LiPo battery the temperature range should be from approximately 40–120° F (5–49° C). Do not store the battery or aircraft in a hot garage, car or direct sunlight. If stored in a hot garage or car the battery can be damaged or even catch fire.
- Never leave batteries, chargers and power supplies unattended during use.
- Never attempt to charge low voltage, ballooned/swollen, damaged or wet batteries.
- Never allow children under 14 years of age to charge batteries.
- Never charge a battery if any of the wire leads have been damaged or shorted.
- Never attempt to disassemble the battery, charger or power supply.
- Never drop batteries, chargers or power supplies.
- Always inspect the battery, charger and power supply before charging.
- Always ensure correct polarity before connecting batteries, chargers and power supplies.
- Always disconnect the battery after charging.
- Always terminate all processes if the battery, charger or power supply malfunctions.

IMPORTANT NOTE: It's safer and better for the longevity of the battery to store it only partially charged for any length of time. Storing the battery approximately 50% charged is typically best, however, it will take some careful management of the charge time and the use of a volt meter to achieve this voltage. If you have the equipment and skills to achieve the 50% charge level for storage it is recommended. If not, simply be sure to not store the battery fully charged whenever possible.

In fact, as long as the battery will be stored at approximately room temperature and for no more than a few weeks before the next use, it may be best to store the battery in the discharged state after the last flight (as long as the battery was not over-discharged on the last flight).

DISCLAIMER

Yuneec Electric Aviation cannot be held liable for any damage, injury or for use of the product in violation with legal regulations, especially in the following circumstances:

Damage and/or injury as well violation of legal regulations resulting from a failure to comply with the operating instructions or the instructions at www.yuneec.com, product information, user manual and other legally binding information.

Damage and/or injury as well violation of legal regulations brought about by the influence of alcohol, drugs, medication or mother narcotics which may impact on the concentration of the user. The same applies to illnesses effecting the concentration of the user (dizziness, tiredness, nausea etc.) or other factors compromising mental and physical capabilities. Intentionally caused damage, injury or violation of legal regulations.

Any request for compensation caused by an accident resulting from use of the product.

Damage and/or injury as well as violation of legal regulations caused by use of the product in a no-fly zone, e.g. next to an airfield, above a motorway or a natural conservation area. Malfunction of the product caused by retrofitting or replacement with components which did not come from Yuneec Electric Aviation.

Damage and/or injury caused by the use of replica parts (non-original parts).

Damage and/or injury as well as violation of legal regulations caused by incorrect operation or misjudgment.

Damage and/or injury caused by damaged spare parts or not using original Yuneec Electric Aviation spare parts.

Damage and/or injury as well as violation of legal regulations caused by ignoring the low voltage battery warning.

Damage and/or injury caused by knowingly and negligibly flying with a damaged model or one which is unfit to fly, e.g. due to dirt, water penetration, coarse particles, oil or a model which has not been correctly or completely assembled or if the main components exhibit visible damage, defects or missing parts.

Damage and/or injury as well as violation of legal regulations caused by operating the model in a magnetic field (e.g. high voltage lines, electricity/transformer stations, radio towers, mobile phone masts etc.), a strong wireless signal environment, no-fly zones, poor visibility and in the event of vision impairments or other impacts on the pilot which are left unchecked etc...

Damage and/or injury brought about through a violation of the legal regulations for operating the model, in unsuitable weather conditions, e.g. rain, wind, snow, hail, storms, hurricanes etc.

Damage and/or injury as well as violation of legal regulations caused by force majeure, e.g. collision, fire, explosion, flooding, tsunami, landslide, avalanche, earthquake or other forces of nature.

Damage and/or injury as well as violation of legal regulations caused by the illegal or immoral use of the model, e.g. capturing videos or recording data which infringes upon/harms the privacy of other people.

Damage and/or injury as well as violation of legal regulations caused by incorrect use of the batteries, protection systems, chargers or aircraft.

Consequential damage caused by the incorrect operation of any kind of system components and accessory parts, especially memory cards, whereby image or video material from the camera can become defect.

Any non-compliance with legal obligations, personal injury, material damage and environmental damage caused by use and a failure to comply with the local laws and regulations.

Damage and/or injury as well as violation of legal regulations caused by hazardous use without sufficient practical experience.

Damage and/or injury as well as violation of legal regulations caused by flying in legally defined no-fly zones. Further losses which do not fall within the scope of use defined by Yuneec Electric Aviation as improper.

This product is designed for both professional use and personal, private use. The national and international laws and regulations in force as the time of take off must be adhered to.

CERTIFICATION INFORMATION

FCC STATEMENT:

This equipment has been tested and found to comply with the limits for Part 15 of the FCC rules. These limits are designed to provide reasonable protection against harmful interference in a residential installation. This equipment generates, uses and can radiate radio frequency energy and, if not installed and used in accordance with the instructions, may cause harmful interference to radio communications.

However, there is no guarantee that interference will not occur in a particular installation. If this equipment does cause harmful interference to radio or television reception, which can be determined by turning the equipment off and on, the user is encouraged to try to correct the interference by one or more of the following measures:

Reorient or relocate the receiving antenna.

Increase the separation between the equipment and receiver.

Connect the equipment to an outlet on a circuit different from that to which the receiver is connected.

This device complies with part 15 of the FCC rules. Operation is subject to the following two conditions:

(1) This device may not cause harmful interference, and (2) this device must accept any interference received, including interference that may cause undesired operation.

NOTE: This equipment has been tested and found to comply with the limits for a Class B digital device, pursuant to part 15 of the FCC Rules. These limits are designed to provide reasonable protection against harmful interference in a residential installation. This equipment generates, uses and can radiate radio frequency energy and, if not installed and used in accordance with the instructions, may cause harmful interference to radio communications. However,

there is no guarantee that interference will not occur in a particular installation. If this equipment does cause harmful interference to radio or television reception, which can be determined by turning the equipment off and on, the user is encouraged to try to correct the interference by one or more of the following measures:

—Reorient or relocate the receiving antenna.

—Increase the separation between the equipment and receiver.

—Connect the equipment into an outlet on a circuit different from that to which the receiver is connected.

—Consult the dealer or an experienced radio/TV technician for help.

RF EXPOSURE WARNING

This equipment must be installed and operated in accordance with provided instructions and the antenna(s) used for this transmitter must be installed to provide a separation distance of at least 20 cm from all persons and must not be co-located or operating in conjunction with any other antenna or transmitter. End-users and installers must be provided with antenna installation instructions and transmitter operating conditions for satisfying RF exposure compliance.

IC RADIATION EXPOSURE STATEMENT FOR CANADA

This device complies with Industry Canada license-exempt RSS standard(s).

Operation is subject to the following two conditions: (1) this device may not cause interference, and (2) this device must accept any interference, including interference that may cause undesired operation of the device.

Le présent appareil est conforme aux CNR d'Industrie Canada applicables aux appareils radio exempts de licence. L'exploitation est autorisée aux deux conditions suivantes : (1) l'appareil ne doit pas produire de brouillage, et (2) l'utilisateur de l'appareil doit accepter tout brouillage radioélectrique subi, même si le brouillage est susceptible d'en compromettre le fonctionnement.

This equipment complies with IC RSS-102 radiation exposure limit set forth for an uncontrolled environment.

Cet équipement respecte les limites d'exposition aux rayonnements IC définies pour un environnement non contrôlé

Article 12

Without permission, any company, firm or user shall not alter the frequency, increase the power, or change the characteristics and functions of the original design of the certified lower power frequency electric machinery.

Article 14

The application of low power frequency electric machineries shall not affect the navigation safety nor interfere a legal communication, if an interference is found, the service will be suspended until improvement is made and the interference no longer exists.

NCC Warning Statement

Without permission, any company, firm or user shall not alter the frequency, increase the power, or change the characteristics and functions of the original design of the certified lower power frequency electric machinery. The application of low power frequency electric machineries shall not affect the navigation safety nor interfere a legal communication, if an interference is found, the service will be suspended until improvement is made and the interference no longer exists.

CE Warning Statement:

Wi-Fi function of this device is restricted only to indoor use when operating in the 5150-5250MHz frequency range.

CAUTION: Any changes or modifications not expressly approved by the party responsible for compliance could void the user's authority to operate this equipment. The module's FCC ID and IC ID are not visible when installed in the host, or If the host is marketed so that end users do not have straight forward commonly used methods for access to remove the module so that the FCC ID and IC ID of the module is visible; then an additional permanent label referring to the enclosed module: Contains Transmitter Module FCC ID: 2AC55-SR24P; IC: 11554B-SR24P or Contains FCC ID: 2AC55-SR24P; IC: 11554B-SR24P must be used.

COLLECTION AND PROCESSING OF DATA

Yuneeec may collect navigation information such as GPS data to help improve our products.

We may also collect Depth Map information and Infrared Image information from your drone delivered to our service center for repair and maintenance service or any other service. We may also collect other information such as device information, server log information, etc. We may also collect personal information used in registration if you choose to become a registered user and any other information user provided to Yuneeec.

We may also collect information which user send to other users, and the recipients and senders of such information.

We reserve the right to disclose your information if required to do so by law or in the good-faith belief that such disclosure is needed to comply with applicable laws, for example in response to a court order, judicial subpoena, warrant or request from government, or otherwise cooperating with government agencies or law enforcement.

We also reserve the right to disclose your information that we believe in good faith is necessary or appropriate to: (i) protect ourselves or others from fraudulent, unlawful, or abusive activities; (ii) take precautions against potential liability; (iii) protect the security of the Yuneeec Apps embedded into or downloaded onto your drone or any associated equipment and services; (iv) protect the legal rights of ourselves or any others.

Any information we collected maybe disclosed or transferred to an acquirer, successor or assignee as part of any potential merger, acquisition, debt financing or other activities that involves transfer of business assets.

We may make the aggregated non-personal information of the users available to third parties for various purposes, including (i) complying with various report obligations; (ii) marketing efforts; (iii) analyzing product safety; (iv) understanding and analyzing our users' interests, habits, usage pattern for certain functionalities, services, content, etc.

CUSTOMER SERVICE

MANUFACTURER:

Yuneeec International (China) Co., Ltd.
Production Address:
East Zhengwei Road No.388, Jinxi
Town, Kunshan City, Jiangsu Province

DISTRIBUTOR:

US: Yuneeec USA Inc.
Address: 5555 Ontario Mills
Parkway, Ontario, CA91764, USA
Tel: +1 855 284 8888

EU: Yuneeec Europe GmbH
Address: Niklaus-Otto-Strasse 4,
24568 Kaltenkirchen, Germany.
Tel: +49 4191 932620

CN: Youyu (Shanghai) Digital Technology Co.,Ltd.
Address: B 15F, 461 HongCao Road,CaoHeJing
Software Building XuHui District, Shanghai, China
Tel: +86 400 8207 506

Any information above might be changed due to the software update. For the latest documents, please check the official website.