

PROSCAN

PLED1960A

TV USER'S MANUAL



LED TV

19" Wide Screen Digital LED TV

Index

1. INTRODUCTION 3

- 1.1. Safety Information 3
- 1.2. TV Base Stand assemble 8
- 1.3. General View 9
 - 1.3.1. Front and Back 9
 - 1.3.2. Connection Panel 10
 - 1.3.3. Remote Control 11

2. INSTALLATION 13

- 2.1. Power Supply Connection 13
- 2.2. RF Antenna Connection 13
- 2.3. Connecting via Composite Video..... 14
- 2.4. Connecting via Component Video 14
- 2.5. Connect to Digital Audio Amplifier..... 15
- 2.6. Connecting via HDMI 15
- 2.7. Connecting to a PC..... 16
- 2.8. Connecting Headphones 16

3. Initial Setup 17

- 3.1. Initial Installation 17
- 3.2. Audio/Video Source Selection 17
- 3.3. DTV Mode Operations 17

4. SETTINGS18

- 4.1. Customizing the PICTUERE Settings18
- 4.2. Customizing the Audio Settings19

- 4.3. Customizing the TIME Settings20
- 4.4. Customizing the SETUP Settings21
- 4.5. Customizing the Patent Settings24
- 4.6. Customizing the TV Settings27

5. PC Mode30

6. TROUBLE SHOOTING 31

7. SPECIFICATIONS33

1. INTRODUCTION

1.1. Safety Information

To ensure reliable and safe operation of this equipment, please read carefully all the instructions in this user guide, especially the safety information below.



CAUTION: TO REDUCE THE RISK OF ELECTRIC SHOCK, DO NOT REMOVE COVER (OR BACK). NO USER-SERVICEABLE PARTS INSIDE. REFER SERVICING TO QUALIFIED SERVICE PERSONNEL.



The lightning flash with arrowhead symbol, within an equilateral triangle is intended to alert the user to the presence of un-insulated “dangerous voltage” within the products enclosure that may be of sufficient magnitude to constitute a risk of electric shock to the persons.

The exclamation point within an equilateral triangle is intended to alert the user to the presence of important operating and maintenance (servicing) instructions in the literature accompanying the appliance.



WARNING: TO REDUCE THE RISK OF FIRE OR ELECTRIC SHOCK, DO NOT EXPOSE THIS APPLIANCE TO RAIN OR MOISTURE.

User Manual

CAUTION: Use of controls or adjustments or performance of procedures other than those specified herein may result in hazardous radiation exposure.

Please, carefully study this manual and always keep it available. There are, however, some installation and operation precautions which you should be aware of:

- 1.READ INSTRUCTIONS:** All the safety and operating instructions should be read before the product is operated.
- 2.RETAIN INSTRUCTIONS:** The safety and operating instructions should be retained for future reference.
- 3.HEED WARNINGS:** All warnings on the product and in the operating instructions should be adhered to.
- 4.FOLLOW INSTRUCTIONS:** All operating and use instructions should be followed.
- 5.CLEANING:** Unplug this product from the wall outlet before cleaning. Do not use liquid cleaners or aerosol cleaners. Use a damp cloth for cleaning.
- 6.ATTACHMENTS:** Do not use attachments not recommended by the product manufacturer as they may cause hazards.
- 7.WATER AND MOISTURE:** Do not use this product near water – for example, near a bath tub, wash bowl, kitchen sink, or laundry tub - in a wet basement or near a swimming pool and the like.
- 8.ACCESSORIES:** Do not place this product on an unstable cart, stand, tripod, bracket or table. The product may fall, causing serious injury to a child or adult and serious damage to the product. Use only with a cart, stand, tripod, bracket or table recommended by the manufacturer or sold with the product. Any mounting of the product should follow the manufacturer’s instructions and should use a mounting accessory recommended by the manufacturer. A product and cart combination should be moved with care: Quick steps, excessive force and uneven surfaces may cause the product and cart combination to overturn.



9. VENTILATION: Slots and openings in the cabinet are provided for ventilation and to ensure reliable operation of the product and to protect it from overheating, and these openings must not be blocked or covered. The openings should never be blocked by placing the product on a bed, sofa, rug, or other similar surface. This product should not be placed in a built-in installation such as a bookcase or rack unless proper ventilation is provided or the manufacturer's instructions have been adhered to.

10. POWER SOURCES: This product should be operated only from the type of power source indicated on the marking label. If you are not sure of the type of power supply to your home, consult your product dealer or local power company.

11. GROUNDING OR POLARIZATION: This product may be equipped with a polarized alternating-current line plug (a plug having one blade wider than the other). This plug will fit into the power outlet only one way. This is a safety feature. If you are unable to insert the plug fully into the outlet, try reversing the plug. If the plug should still fail to fit, contact your electrician to replace your obsolete outlet. Do not defeat the safety purpose of the polarized plug.

12. POWER-CORD PROTECTION: Power-supply cords should be routed so that they are not likely to be walked on or pinched by items placed upon or against them, paying particular attention to cords at plugs, convenience receptacles, and the point where they exit from the product.

13. OUTDOOR ANTENNA GROUNDING: If an outside antenna or cable system is connected to the product, be sure the antenna or cable system is grounded so as to provide some protection against voltage surges and built-up static charges. Article 810 of the National Electrical Code, ANSI/NFPA 70, provides information with regard to proper grounding of the mast and supporting structure, grounding of the lead-in wire to an antenna discharge unit, size of grounding conductors, location of antenna-discharge unit, connection to grounding electrodes, and requirements for the grounding electrode.

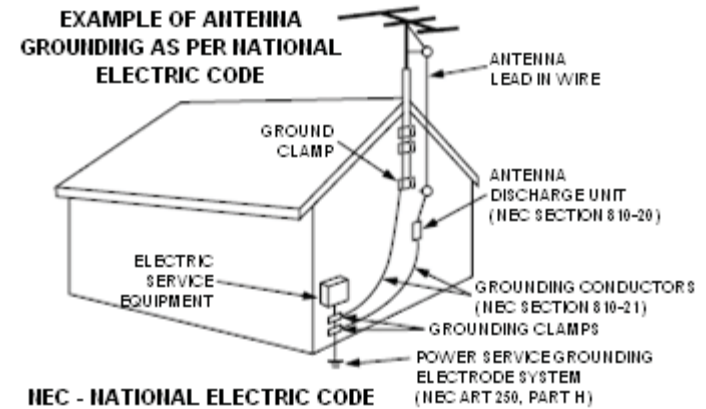

14. LIGHTNING: For added protection for this product during a lightning storm, or when it is left unattended and unused for long periods of time, unplug it from the wall outlet and disconnect the antenna or cable system. This will prevent damage to the product due to lightning and power-line surges.

15. POWER LINES: An outside antenna system should not be located in the vicinity of overhead power lines or other electric light or power circuits, or where it can fall into such power lines or circuits. When installing an outside antenna system, extreme care should be taken to keep from touching such power lines or circuits as contact with them might be fatal.

16. OVERLOADING: Do not overload wall outlets, extension cords, or integral convenience receptacles as this can result in a risk of fire or electric shock.

17. OBJECT AND LIQUID ENTRY: Never push objects of any kind into this product through openings as they may touch dangerous voltage points or short-out parts that could result in a fire or electric shock. Never spill liquid of any kind on the product.

18. SERVICING: Do not attempt to service this product yourself as opening or removing covers may expose you to dangerous voltage or other hazards. Refer all servicing to qualified service personnel.

19. DAMAGE REQUIRING SERVICE: Unplug this product from the wall outlet and refer servicing to qualified service personnel under the following conditions:

- When the power-supply cord or plug is damaged.
- If liquid has been spilled, or objects have fallen into the product.
- If the product has been exposed to rain or water.
- If the product does not operate normally by following the operating instructions. Adjust only those controls that are covered by the operating instructions as an improper adjustment of other controls may result in damage and will often require extensive work by a qualified technician to restore the product to its normal operation.
- If the product has been dropped or damaged in any way.
- When the product exhibits a distinct change in performance – this indicates a need for service.

20. REPLACEMENT PARTS: When replacement parts are required, be sure the service technician has used replacement parts specified by the manufacturer or have the same characteristics as the original part. Unauthorized substitutions may result in fire, electric shock, or other hazards.

21. SAFETY CHECK: Upon completion of any service or repairs to this product, ask the service technician to perform safety checks to determine that the product is in proper operating condition.

22. WALL OR CEILING MOUNTING: The product should be mounted to a wall or ceiling only as recommended by the manufacturer.

23. HEAT: The product should be situated away from heat sources such as radiators, heat registers, stoves, or other products (including amplifiers) that produce heat.

24. MAINS PLUG: Is used as the disconnect device. It shall remain readily operable, and should not be obstructed during intended use.

1.2. TV Base Stand assemble

1. Match the TV unit into the stand, then hold the TV stand, revolve and lock the tv unit tightly as the arrowhead point.
2. Fix the screws into the TV stand after installing the tv unit and tv stand.

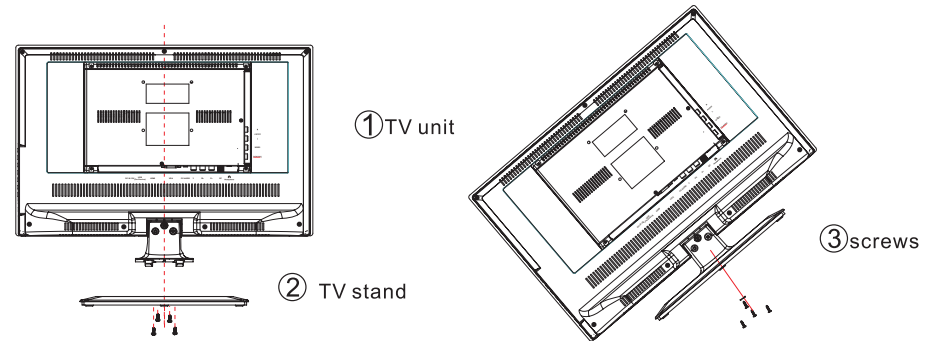

3. Mounting on the wall

This unit is VESA-compliant, and is designed to be wall-mounted with a VESA-compliant 3"x3" (75mmx75mm) mounting kit designed for flat-panel TVs (not supplied). Mount this unit according to the instructions included in the mounting kit. Length of screw should not exceed 8 mm

NOTE

Remove the base stand before mounting the unit on the wall.

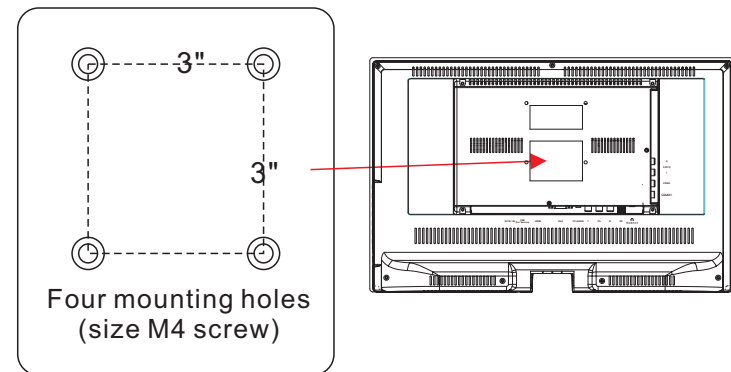

1.3. General View

1.3.1. Front and Back

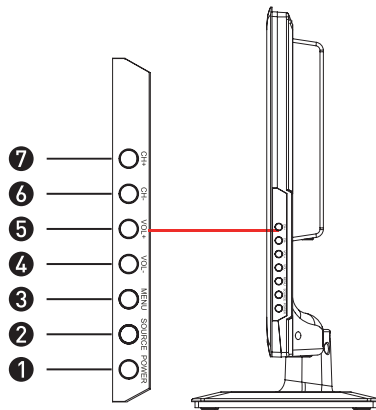
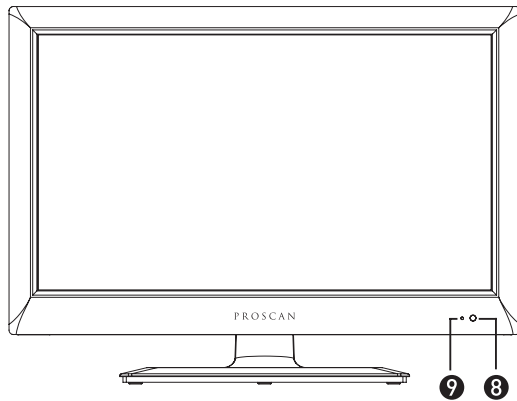

- 1. **POWER:** Turn on TV/Standby
- 2. **SOURCE:** Audio/video input source selection
- 3. **MENU:** Open settings menu
- 4. **VOL-:** Decrease volume
- 5. **VOL+:** Increase volume
- 6. **CH-:** Previous channel
- 7. **CH+:** Next channel
- 8. **IR RECEIVER:** Receives infrared signals from the remote control
- 9. **INDICATOR LED:** Status indicator (Power On: Green / Standby: Red)

1.3.2. Connection Panel

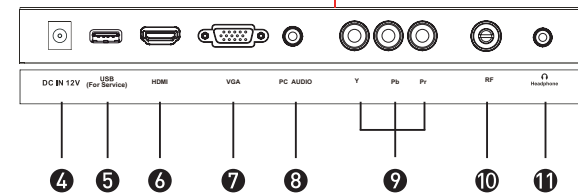
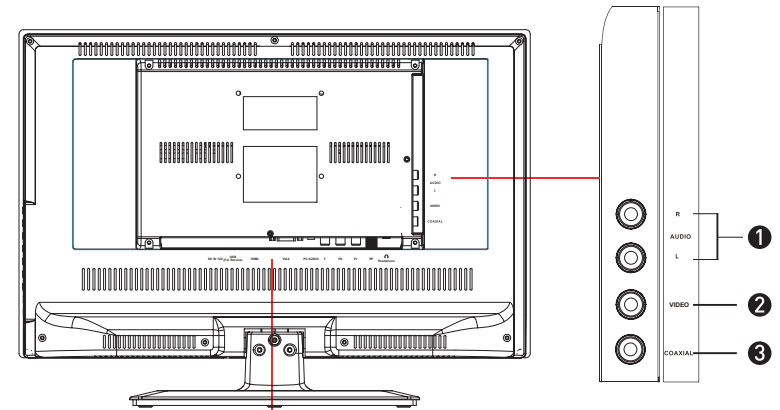

- 1. **AUDIO IN R/L:** Stereo audio input
- 2. **Video:** Video input
- 3. **Coaxial:** Digital audio output
- 4. **DC IN 12V**
- 5. **USB Host port**
- 6. **HDMI**
- 7. **VGA:** PC video input
- 8. **PC AUDIO:** Connect it to the audio output terminal of PC
- 9. **YPbPr:** Connect to the YPbPr video output terminal of DVD
- 10. **RF:** Antenna connection
- 11. **Headphones**

1.3.3. Remote Control

BASIC OPERATIONS

1. **POWER:** Turn on the TV/Standby
2. **SOURCE:** Show input the source Menu
3. **MUTE:** Mute the sound from speakers
4. **NUMBER KEYS:** Change the channel directly
5. **-:** Select channel with two digits
6. **↶:** Return to the previous channel tuned
7. **MENU:** Show Menu
8. **INFO:** Show information about the current programme
9. **EPG:** Show the Electronic Program Guide
10. **EXIT:** Exit the Menu
11. **NAVIGATION KEYS (Up, Down, Left, Right,OK):** To move in the menus and confirm settings
12. **VOL:** Increase and decrease volume
13. **CH:** Next and Previous Channel
14. **MTS:** Audio language selection
15. **CC:** CC mode
16. **FREEZE:** Freeze the image
17. **CHLIST:** Displays channel lists on the screen
18. **P. MODE:** Output image mode
19. **ASPECT:** Selects the screen size
20. **S. MODE:** Setting audio options

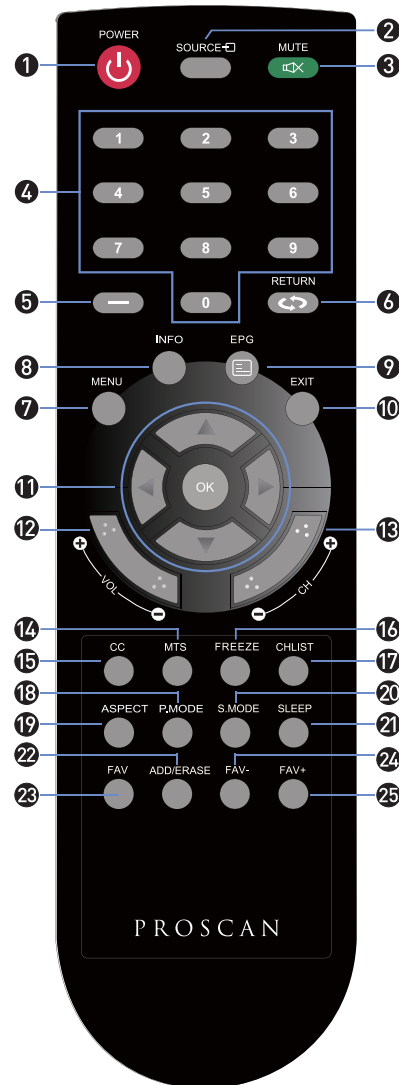

Universal Remote Code:08F7
(Universal Remote Control is not included)

21. **SLEEP:** Auto Power Off Timer
22. **ADD/ERASE:** Add or delete a file
23. **FAV:** Show the list of favorite channels
24. **FAV-:** Previous favorite channel
25. **FAV+:** Next favorite channel

Install the Batteries

If the remote control fails to operate the TV functions, replace the batteries in the remote control.

- 1 Open the battery cover.
- 2 Insert two size-AAA batteries.(Place the batteries with their terminals corresponding to the (+) and (-) indications in the battery compartment.)
- 3 Replace the cover.

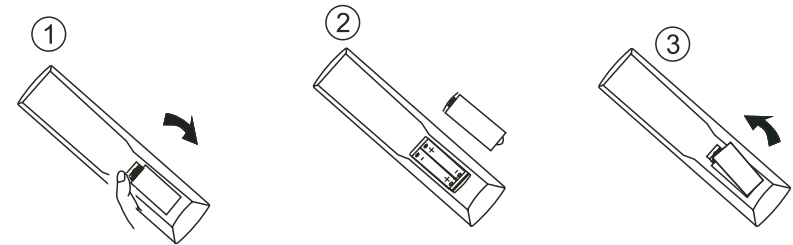

Precaution on battery use

Improper use of batteries can result in a leakage of chemicals and/or explosion. Be sure to follow the instructions below.

- * Place batteries with their terminals corresponding to the (+) and (-) indications.
- * Different types of batteries have different characteristics. Do not mix batteries of different types.
- * Do not mix old and new batteries. Mixing old and new batteries can shorten the life of new batteries and/or cause old batteries to leak chemicals.
- * Remove batteries as soon as they are non-operable. Chemicals that leak from batteries can cause a rash. If chemical leakage is found, wipe with a cloth.
- * If the remote control is not used for an extended period of time, remove the batteries from the remote control.
- * The batteries (battery pack of batteries installed) shall not be exposed to excessive heat such as sunshine, fire or the like.

2. INSTALLATION

2.1. Power Supply Connection

Connect the power adaptor to a home power outlet.



2.2. RF Antenna Connection

Connect the antenna as shown in the figure to receive the analog or digital (DTT) TV signal.

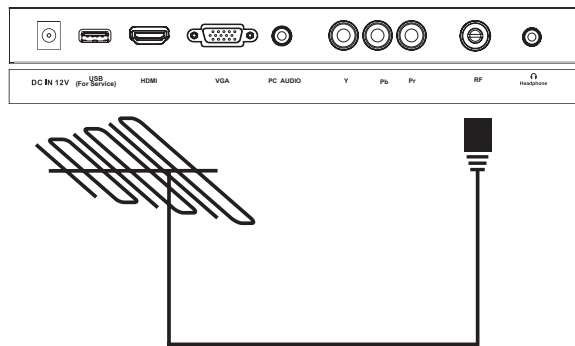

2.3. Connecting via Composite Video

Connect your video player, decoder, DVD or similar with the corresponding tri-color RCA cable, from the AV output (audio/video) of your video equipment to the video and audio input to your TV by the cable, as shown in the figure.

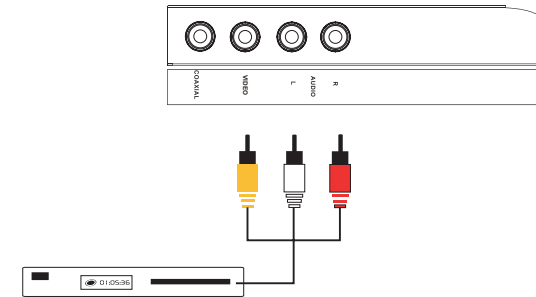

2.4. Connecting via Component Video

Connect your video player, decoder, DVD or similar with an RCA cable, from the YPbPr video output of the device to the video input on your TV by the cable, as shown in figure. Through this entry you can get HD video. Use a second RCA cable to connect the audio to AUDIO IN R/L.

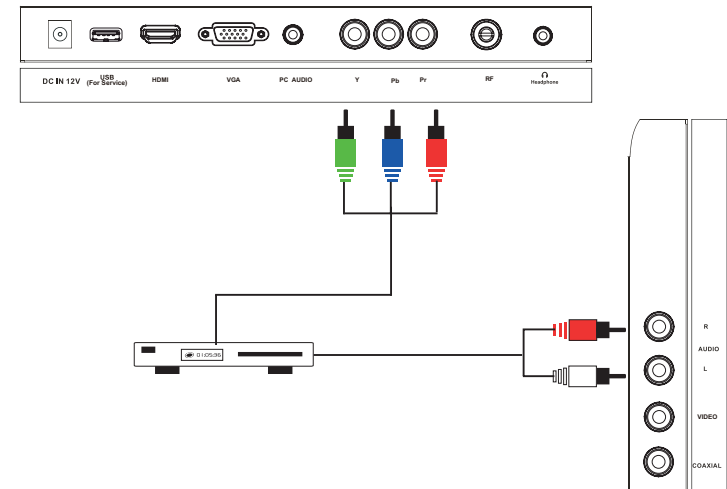

2.5. Connect to Digital Audio Amplifier

Take the coaxial digital audio output of your TV to connect to a hifi system you have, and improve your sound experience.

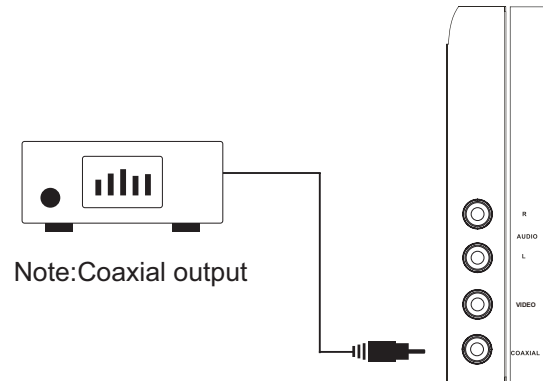

2.6. Connecting via HDMI

Connect your video player, decoder, DVD or similar, with the corresponding HDMI cable from the HDMI output of your video equipment to one of the HDMI input on your TV, as shown in figure. This cable transfers HD video and audio.

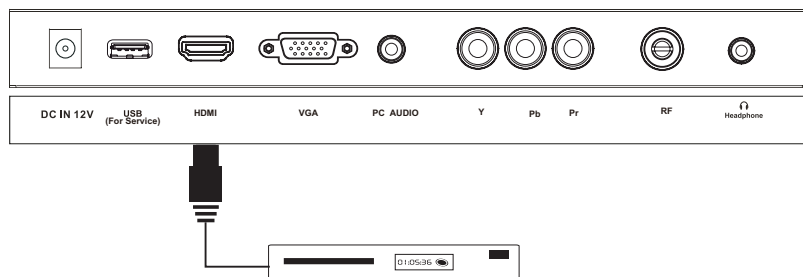

2.7. Connecting to a PC

Connect the VGA output (RGB) from your PC to the corresponding input on your TV, and the audio output from your computer to the PC AUDIO input of your television.

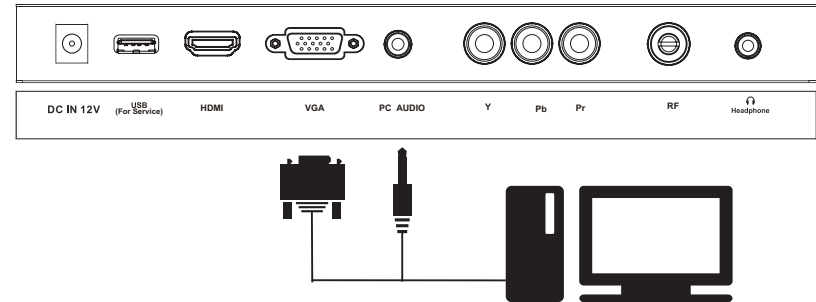

2.8. Connecting Headphones

Use the HEADPHONES output of your TV set to listen the audio of the unit through your own stereo headphones. When you connect headphones to the unit, the main speakers will be silenced.

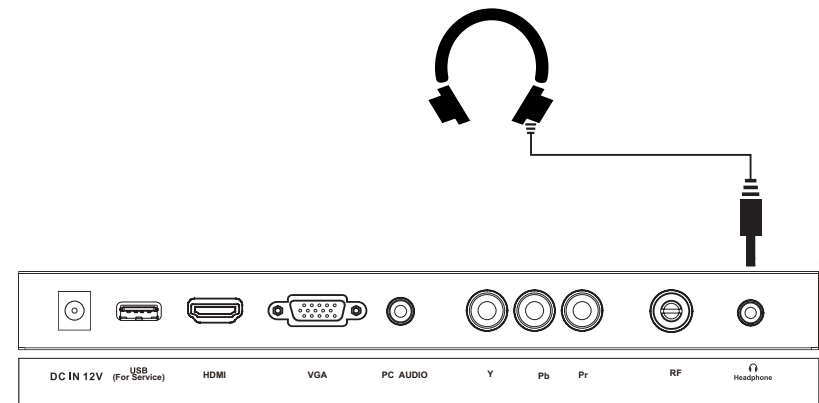

3. Initial Setup

3.1. Initial Installation

The first time the unit is turned on or anytime the system is restored to the defaulted settings, the Initial Installation wizard will be displayed on the screen.

Connect the antenna cable to the RF connector at the connections panel and follow the steps displayed on the screen to set up the system basic settings (Language, Cable, etc.) and start an auto search of TV channels.

3.2. Audio/Video Source Selection

Turn on the TV by pressing the **POWER** button on TV or on the remote control, press **SOURCE** and use the direction buttons **▲** / **▼** to select the desired source depending on the equipment you have connected (AV, HDMI, VGA) or choose TV to enter these mode.

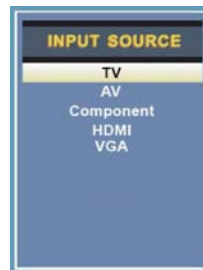

3.3. DTT Mode Operations

Use **CH+** or **CH-** buttons to tune the desired channel, or enter the channel number directly using the numeric keypad. Press **OK** to display on screen the list of TV and radio channels (press the **◀**/**▶** buttons to sort by group and show only the DTV, the analog TV channels, Radio channels, etc.).

Use **MTS** button to select the audio language broadcasting, **CC** button to show or hide subtitles on screen and **FAV** button to see a list of your favorite channels.

4. SETTINGS

4.1. Customizing the PICTURE Settings

Select TV source for example. (Press **SOURCE** button to select TV mode)

1. Press the **POWER** button to turn the LCD TV on.
2. Press the **MENU** button on the remote control to display the Main menu, and use the **◀**/**▶** buttons to select the **PICTURE**.
3. Use the **▲**/**▼** buttons to highlight an individual **PICTURE** option, use the **◀**/**▶** buttons to change the setting, and press the **MENU** button to exit the menu.



The PICTURE menu includes the following options:

Picture Mode	Cycle among picture display modes: Standard, Dynamic, Mild, user.
Contrast	Control the difference between the brightness and darkest regions of the picture.
Brightness	Control the overall brightness of the picture.
Color	Control the color.
Tint	Controls the tint.
Sharpness	Increase this setting to see crisp edges in the picture; decrease it for soft edges.
Color Temp.	Cycles among color modes: Normal, Warm, Cool.

4.2. Customizing the Audio Settings

Select TV source for example. (Press SOURCE button to select TV mode)

1. Press the POWER button to turn the LCD TV on.
2. Press the MENU button on the remote control to display the Main menu, and use the ◀/▶ buttons to select the AUDIO.
3. Use the ▲/▼ buttons to highlight an individual AUDIO option, use the ◀/▶ buttons to change the setting, and press the MENU button to exit the menu.



The AUDIO menu includes the following options:

Sound Mode	Allow you to select among: Standard, Music, Movie and User.
Bass	Control the relative intensity of lower pitched sounds.
Treble	Control the relative intensity of higher pitched sounds.
Balance	To adjust the balance of the left and right sound track, or turn off the volume of the left and right sound track.
Surround	Allow you to select between Off and On.
SPDIF Type	Allow you to select between PCM and RAW.
Audio Language	Allow you to select audio language among: English, French and Spanish.

4.3. Customizing the TIMER Settings

Select TV source for example. (Press SOURCE button to select TV mode)

1. Press the POWER button to turn the LCD TV on.
2. Press the MENU button on the remote control to display the Main menu, and use the ◀/▶ buttons to select the TIMER.
3. Use the ▲/▼ buttons to highlight an individual TIMER option, use the ◀/▶ buttons to change the setting, and press the MENU button to exit.



The TIMER menu includes the following options:

Sleep Timer	Allow you to set up the sleep timer among: 5min, 10min, 15min, 30min,45min, 60min, 90min, 120min, 180min, 240min and off.
Time Zone	Allow you to set up the sleep timer among: Pacific, Alaska, Hawaii, Eastern, Central and Mountain.
Daylight Saving Time	Allow you to turn on or off the daylight saving time.

4.4. Customizing the SETUP Settings

Select TV source for example. (Press SOURCE button to select TV mode)

1. Press the POWER button to turn the LCD TV on.
2. Press the MENU button on the remote control to display the Main menu, and use the ◀/▶ buttons to select the SETUP.
3. Use the ▲/▼ buttons to highlight an individual SETUP option, use the ◀/▶ buttons to change the setting, and press the MENU button to exit.



The TIMER menu includes the following options:

Menu Language	Allow you to select menu language among: English, Français and Español.
Transparency	Allow you to turn on or off the transparency function.
Zoom Mode	Allow you to select the zoom mode among: Wide, Zoom, Cinema and Normal.
Noise Reduction	Allow you to select the noise reduction mode among: Middle, Strong, Off, Weak.
Advance	Input PC signal first, then press SOURCE button to select VGA mode, press ▶ button to confirm.



H-Position	Allow you to use the ◀/▶ buttons to adjust the H Position.
V-Position	Allow you to use the ◀/▶ buttons to adjust the V Position.
Clock	Allow you to prolong the image.
Phase	Allow you to adjust the definition.
Auto	Select "Auto" and press the ▶ button, the unit will automatically adjust all items to achieve a best effect.

Close Caption

Use the ▼ button to highlight the Close Caption item, then press the ▶ button to enter into the following menu.



CC Mode	Allow you to select the CC Mode among: Off, On and CC on Mute.
Basic Selection	Allow you to select the basic selection among: CC1, CC2, CC3, CC4, Text1, Text2, Text3 and Text4.
Advanced Selection	Allow you to select the advanced selection among: Service1, Service2, Service3, Service4, Service 5 and Service6.
Option	Use the ▼ button to highlight the "Option" item, then press the ▶ button to enter into the following menu.



Use the ▲/▼ buttons to highlight the desired item, and use the ◀/▶ buttons to select.

XVS To turn on or off the XVS function.

Restore Default Restore all settings in SETUP menu to factory settings.



4.5. Customizing the LOCK Settings

Select TV source for example. (Press SOURCE button to select TV mode)

1. Press the POWER button to turn the LCD TV on.
2. Press the MENU button on the remote control to display the Main menu, and use the ◀/▶ buttons to select the LOCK.
3. Use the ▼ button to highlight “Enter Password” item, use the numeric keys to input 4-digital password. After you that, the screen will display the junior menu. After settings, press menu button to exit.

NOTE: The factory password is 0000. The supervision password is 8899.

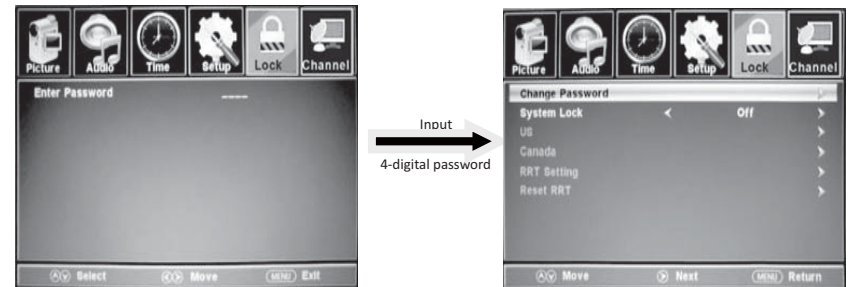

The LOCK menu includes the following options:

Change Password Use the ▼ button to select the “Change Password” item, then press the ▶ button to enter into the following menu.



Input the new 4-digital password and input it again to confirm.

System Lock Allow you to turn on or off the system lock. If you turn off the system lock, then the following items (US, Canada, RRT Setting and Reset RRT) will unable to use.

US

Use the ▼ button to highlight the “US” item, then press the ► button to enter into the following menu.



TV Use the ▼ button to highlight the “TV” item, then press ► button to enter into the following menu.



Use the ▲/▼ buttons to select the desired rating and press the ► button to block or unblock rating.

MPAA The Movie rating (MPAA) is used for original movies rated by the Motion Picture Association (MPAA) as broadcasted on cable TV and not edited for television. Use the ▲/▼ buttons to select N/A, G, PG, PG-13, R, NC-17 or X.

RATING	DESCRIPTION
G	General Audiences. Movie is appropriate for all ages.
PG	Parental Guidance Suggested. May contain material not suited for younger viewers
PG-13	Contains content that may not be appropriate for viewers under the age of 13.
R	Restricted. Contains adult content, no one under 17 admitted without parent.
NC-17	No one 17 and under admitted.
X	Adults only.

Canada Use the ▼ button to highlight the “Canada” item, then press ► button to enter into the following menu.



Canada Eng Use the ◀/▶ buttons to select among: E, C, C8+, G, PG, 14+ and 18+.

Canada Fre Use the ◀/▶ buttons to select among: E, G, 8ans+, 13ans+, 16ans+ and 18ans+.

RRT Setting

Reset RRT Allow you to reset the RRT setting.

4.6. Customizing the CHANNEL Settings

Select TV source for example. (Press SOURCE button to select TV mode)

1. Press the POWER button to turn the LCD TV on.
2. Press the MENU button on the remote control to display the Main menu, and use the ◀/▶ buttons to select the CHANNEL.
3. Use the ▲/▼ buttons to highlight an individual CHANNEL option, use the ◀/▶ buttons to change the setting, and press the MENU button to exit.



The CHANNEL menu includes the following options:

Air/Cable	Allows you to select antenna between Air and Cable. If you select "Cable", the following items (Favorite, Show/Hide, Channel NO., Channel Label and DTV Signal) are unable to use.
Auto Scan	Use the ▼ button to highlight the "Auto Scan" item, then press ► button to enter into the following menu.



If you select "Air" as input signal in Antenna item, you can press the ► button to search the channels automatically.



The receivable channels will be stored automatically.

When searching channels, press MENU to stop.

If you select "Cable" as input signal in Antenna item, allows you to select Cable System among: Auto, STD, IRC and HRC.

Use the ▼ button to highlight the "Start to Scan", then press the ► button to search the channels automatically.

The receivable channels will be stored automatically.

When searching channels, press MENU to stop.

Favorite

Allow you to add these channels which you desired as the favorite channels. Use the ▲/▼ buttons to highlight the "Favorite" item, then press the ► button to enter into the following menu.



Use the ▲/▼ buttons to highlight the desired item, then press OK button to add or remove the highlighted channel as favorite.

Show/Hide

Allow you to show or hide the channels.

Use the ▲/▼ buttons to highlight the "Show/Hide" item, then press the ► button to enter into the following menu.



Use the ▲/▼ buttons to highlight the desired item, then press OK button to show or hide the highlighted channel.

Channel No.	Display the number of current channel.
Channel Label	Display the lable of current channel.
DTV Signal	Display the quality of current DTV signal.

5. PC Mode

Setting up your PC software (based on Windows XP)

The Windows display-settings for a typical computer are shown below. But the actual screen on your PC will probably be different, depending upon your particular version of Windows and your particular video card. But even if your actual screen looks different, the same, basic set-up information will apply in almost all cases.

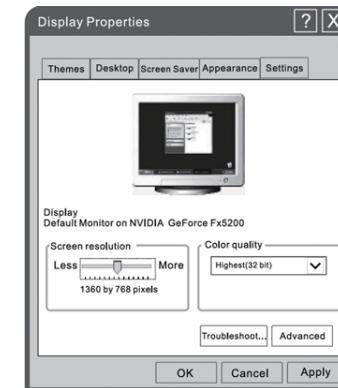



1. First, click on "Control Panel" on the Windows start menu.
2. When the control panel window appears, click on "Appearance and Themes" and a display dialog-box will appear.
3. When the control panel window appears, click on "Display" and a display dialog-box will appear.
4. Navigate to the "Setting" tab on the display dialog-box. The correct size setting (resolution) Optimum: 1360x768.

If a vertical-frequency option exists on your display settings dialog box, the correct value is "60Hz". Otherwise, just click "Enter" and exit the dialog box.

Resolution	Horizontal Frequency (KHz)	Vertical Frequency (Hz)	Standard Mode
720x400	31.47	70	DOS
640x480	37.9	60	VGA
800x600	37.9	60	SVGA
1024x768	48.4	60	XVGA
1366x768	64	60	SXVGA

6. TROUBLE SHOOTING

If the device performance fails, check whether the detected problem is in the following table. If your device still fails, contact the customer service.

TV no display, and prompt no signal input, red indicator LED twinkling	- Signal cable is loose or fallen off.	- Check signal cable whether or not loose, fall off, reconnect again.
Remote control distance is short, lose control	- Receive window of remote control was covered by objects. - The battery energy of remote control is too low.	- Remove objects obstructing the receiver window of remote control. - Change battery.
TV display is faint	- Adjustment is incorrect. - Display mode is incorrect.	- Use auto-adjustment function. - Use recommended mode.
TV display image does not fill the screen	- Adjustment is incorrect. - Display mode is incorrect.	- Use auto-adjustment function. - Enter PICTURE to adjust horizontal or vertical position. - Use recommended mode.
Can not operate this machine	- Exterior influence, for example lightning, static electricity and so on, which are possibly to disturb the normal operation of this machine.	- Press  button to turn off electrical source, then press  button to turn on the TV again after 1-2 minutes.

Snowflake speckle and sound noise	- Antenna cable connector is loose, cable is damaged. - Antenna cable type is not matching. - Direction or position of antenna is incorrect. - Signal is weak.	- Check the antenna cable connector plug whether or not loose, cable whether or not perfect. - Check antenna cable type (VHF/UHF). - Adjust direction or position of antenna. - Attempt to use signal amplifier.
TV image is better, but has noise	- Antenna cable connector is loose, cable is damaged.	- Check the antenna cable connector plug whether or not loose, check cable condition.
No image. No sound	- Power plug is loose, power cord don't connect well.	- Check power cord whether or not connect well. - Press POWER on panel or remote control. - Check if the  button is on.
TV image has stripes	- Signal is exposed to interference, such as car, neon light, electric blower, etc.	- Don't use electric blower around machine, adjust antenna cable direction to reduce interference.
TV image has shadows	- TV signal is reflected by valley or building. - Direction of antenna is incorrect.	- Use high directional antenna. - Adjust direction of antenna.
TV no sound	- Volume setting is too low. - Sound is muted.	- Adjust volume to proper value. - Press MUTE to eliminate mute.

CAUTION: Don't let your machine display the same picture for a long time, please set up a screen protection procedure. If a high contrast picture remains for a long time, this picture will bring a "leave shadow" in screen. Usually the "leave shadow" will disappear gradually when you turn off the machine power. However, this trouble can't be repaired, which isn't in range of warranty.

7. SPECIFICATIONS

Screen

Model	PLED1960A
TV System	ATSC/NTSC
Maximum Resolution	1366 x 768
Brightness	220cd/m ²
Static Contrast	1000:1
Response Time	5ms
Consumption	<36W
Power Supply	DC IN: 12V/3A
Connectivity	Composite Video Input Component Video Input YPbPr PC Video Input (VGA) PC Audio Input HDMI Input RF Antenna Input
	Headphones Audio Output Coaxial Digital Audio Output
Data Interface	USB(For service)
Supported System Files	FAT32 and FAT16
Panel	A type

Remote Control

Signal Type	Infrared
Control Distance	8 meters
Control Angle	30° (Horizontal)
Power Supply	AAA 1.5Vx2



Energy Verified
Rendement
Énergétique Vérifié