

LoadLifter™ series

RideControl™

Air Lift 1000HD™

Air Lift 1000™



User Guide

Which kit is on the vehicle?

LoadLifter 5000 Ultimate Plus

Stainless steel roll plates, braided stainless steel air lines



LoadLifter 5000 Ultimate

Black powder-coated steel roll plates



LoadLifter 5000

Zinc-coated steel roll plates



LoadLifter 7500XL

"5815" on side of air springs



RideControl

Sleeve-style air springs



Air Lift 1000HD

Black air springs inside coil springs



Air Lift 1000

Red air springs inside coil springs



MY PRESSURE SETTINGS

Left

Right

Both

Camper _____

Boat trailer _____

Utility trailer _____

Work trailer _____

Max pressure _____

Vehicle _____

Ex. 2017 Ford F-250 Super Duty

Installed kit _____

Ex. LoadLifter 5000 Ultimate

Index

| | |
|---|----|
| Introduction, Notation Explanation, Important Safety Notice | 4 |
| LoadLifter, RideControl Pressure Settings, Guidelines for Use | 5 |
| Air Lift 1000HD, Air Lift 1000 Pressure Settings, Guidelines for Use | 6 |
| Post-Installation Checklist, Maintenance Guidelines | 7 |
| Finding Air Leaks, Fixing Air Leaks on Barbed Fittings | 8 |
| Cutting Air Lines | 9 |
| Fixing Air Leaks on PTC Fittings, Fixing Air Leaks on Braided Stainless Steel Air Lines | 10 |
| Adjusting Air Pressure | 11 |
| Choosing the Right On-Board Air Compressor System | 12 |
| Troubleshooting Guide, Frequently Asked Questions | 14 |
| Limited Warranty and Return Policy, Replacement Part Information, Contact Information | 15 |

INTRODUCTION

Thank you for purchasing an Air Lift product. It is important to read and understand the entire User Guide before operating the Air Lift system.

Air Lift Company reserves the right to make changes and improvements to its products and publications at any time. For the latest version of this User Guide, contact Air Lift Company at **(800) 248-0892** or visit **www.airliftcompany.com**.

NOTATION EXPLANATION

This kit does not alter the gross vehicle weight rating (GVWR) or payload of the vehicle. Check the vehicle's safety compliance certification

label or the owner's manual and do not exceed the maximum load listed for this vehicle.

Gross vehicle weight rating (GVWR): The maximum allowable weight of the fully loaded vehicle (including passengers and cargo). This number — along with other weight limits, as well as tire, rim size and inflation pressure data — is shown on the vehicle's Safety Compliance Certification Label.

Payload: The combined, maximum allowable weight of cargo and passengers that the vehicle is designed to carry. Payload is GVWR minus the base curb weight.



INDICATES IMMEDIATE HAZARDS WHICH WILL RESULT IN SEVERE PERSONAL INJURY OR DEATH.



INDICATES HAZARDS OR UNSAFE PRACTICES WHICH COULD RESULT IN SEVERE PERSONAL INJURY OR DEATH.



INDICATES HAZARDS OR UNSAFE PRACTICES WHICH COULD RESULT IN DAMAGE TO THE MACHINE OR MINOR PERSONAL INJURY.

IMPORTANT SAFETY NOTICE



FOR SAFETY AND TO PREVENT POSSIBLE DAMAGE TO THE VEHICLE, DO NOT EXCEED MAXIMUM GROSS VEHICLE WEIGHT RATING (GVWR), AS INDICATED BY THE VEHICLE MANUFACTURER.

LOADLIFTER, RIDECONTROL PRESSURE SETTINGS

| Minimum Air Pressure | Maximum Air Pressure* |
|--|-----------------------|
| 5 PSI (.34BAR) | 100 PSI (7BAR) |
| <div style="display: flex; align-items: center;"> <div style="background-color: #ffff00; padding: 5px; margin-right: 10px;"> </div> <div> <p>CAUTION FAILURE TO MAINTAIN CORRECT MINIMUM PRESSURE (OR PRESSURE PROPORTIONAL TO LOAD) COULD LEAD TO PREMATURE AIR SPRING FAILURE AND WILL VOID THE WARRANTY.</p> </div> </div> | |

* Check Installation Guide for maximum pressure for this kit. The Installation Guide can be obtained at www.airliftcompany.com.

GUIDELINES FOR USE

1. Check air pressure weekly.
2. Never inflate to more than 100 PSI (7BAR).
3. Operating the vehicle below the minimum air spring pressure will void the Air Lift warranty.
4. Always add pressure to the air springs in small quantities, checking the pressure frequently.
5. When increasing load, always adjust pressure to maintain normal or desired ride height. Increase or decrease pressure from the system as necessary to attain normal ride height for optimal ride and handling.

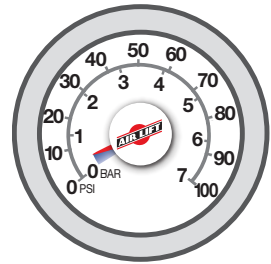

Minimum pressure **5 PSI**
at all times **.34BAR**

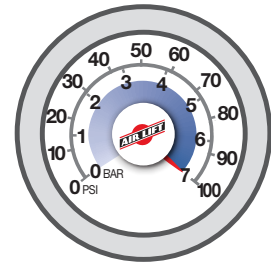

Max **100 PSI**
pressure **7BAR**

AIR LIFT 1000HD, AIR LIFT 1000 PRESSURE SETTINGS

| Minimum Air Pressure | Maximum Air Pressure* |
|---|---|
| 5 PSI (.34BAR) | 35 PSI (2.4BAR) OR 50 PSI (3.5BAR) |
| <div style="display: flex; align-items: center;"> <div style="background-color: yellow; padding: 5px; margin-right: 10px;"> </div> <div> <p>CAUTION FAILURE TO MAINTAIN CORRECT MINIMUM PRESSURE (OR PRESSURE PROPORTIONAL TO LOAD) COULD LEAD TO PREMATURE AIR SPRING FAILURE AND WILL VOID THE WARRANTY.</p> </div> </div> | |

* Check Installation Guide for maximum pressure for this kit. The Installation Guide can be obtained at www.airliftcompany.com.

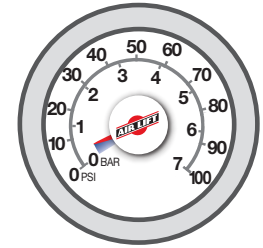

Minimum pressure **5 PSI**
.34BAR
at all times

GUIDELINES FOR USE

1. Check air pressure weekly.
2. Never inflate to more than the recommended maximum air pressure.
3. Operating the vehicle below the minimum air spring pressure will void the Air Lift warranty.
4. Always add air to springs in small quantities, checking the pressure frequently.
5. When increasing load, adjust air pressure to maintain normal ride height. Increase or decrease pressure from the system as necessary to attain normal ride height for optimal ride and handling.

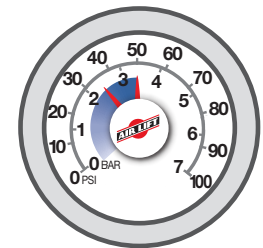

Max pressure **35 or 50 PSI**
2.4 or 3.5BAR

POST-INSTALLATION CHECKLIST

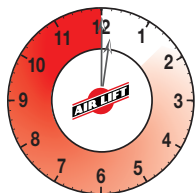

24-HOUR

Pressure check

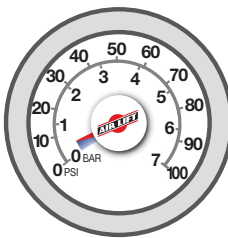

Minimum
pressure
at all times

5 PSI
.34BAR

- Overnight leak down test** — Recheck air pressure after the vehicle has been used for 24 hours. If the pressure has dropped more than 5 PSI (.34BAR), there could be a leak that may need to be fixed. See page 8 for tips on finding air leaks.
- Air pressure requirements** — It is important to understand the air pressure requirements of the air spring system. Regardless of load, the air pressure should be adjusted to maintain

MAINTENANCE GUIDELINES

1. Periodically check the air spring system fasteners for tightness (torque specifications can be found in the Installation Guide). Also, check the air springs for any signs of rubbing. Realign the air spring components, if necessary.

adequate ride height at all times while driving.

- Thirty-day or 500-mile (800km) test** — Recheck the air spring system after 30 days or 500 miles (800km), whichever comes first. If any part shows signs of rubbing or abrasion, the source should be identified and moved, if possible. If it is not possible to relocate the cause of the abrasion, the air spring may need to be remounted. If professionally installed, the installer should be consulted. Check all fasteners for tightness. Consult the installation guide for the kit for proper torque specifications if any fasteners have loosened.

00050mi

OR

30
days

FINDING AIR LEAKS

1. Inflate the air springs to 30 PSI (2.1BAR).
2. Spray all connections with a solution of liquid dish soap and water. Wait 30 seconds and check for bubbles which indicate leaks.
3. Check the air pressure again after 24 hours. A 2-4 PSI (.14-.28BAR) loss after initial installation is normal. Retest for leaks if the loss is more than 5 PSI (.34BAR).
4. After checking for leaks, deflate the air springs to the minimum pressure required to restore the system to normal ride height.

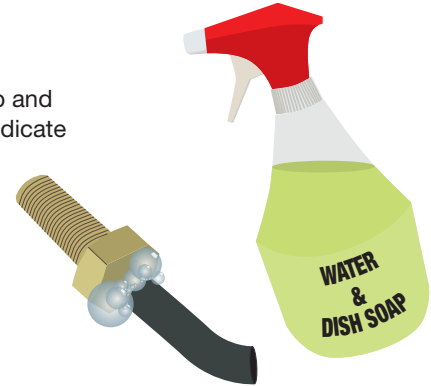

FIXING AIR LEAKS ON BARBED FITTINGS

1. If there is a leak at the Schrader valve, tighten the valve with a valve core tool.
2. If there is a leak at any barbed fitting, cut the air line 1 1/2" (38mm) behind the fitting. Use a pair of pliers or locking pliers to twist and pull the air line off of the fitting. Do not cut the air line lengthwise at the fitting because this could nick the barbs, likely causing it to leak.
3. Reinstall the air line and the air line clamp if the fitting has one. Make sure the air line covers all barbs.
4. See "Cutting Air Lines," page 9. For push-to-connect (PTC) fittings and stainless steel braided air lines, see page 10.



CUTTING AIR LINES

When cutting air lines, use a sharp knife or a hose cutter and make clean, square cuts. Do not use scissors or wire cutters because these tools will deform the air line, causing it to leak around fittings. Do not cut the lines at an angle.

The maximum bend radius for 1/4" air line is 1" (25mm). Do not bend the air line more than the maximum bend radius or side load the fitting connections. Air lines are to be installed straight into fittings.

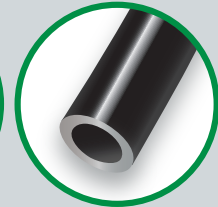
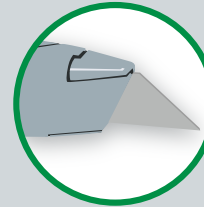

Go to
air-lift.co/cuttingairline
to watch a video on
proper air line cutting.



FIXING AIR LEAKS ON PTC FITTINGS

After insertion, check the PTC fitting connection by pulling on each line to verify a robust connection.

To release the air line from the connection, first release all air from the system. Push in on the air

line (step 1), push the collar in (step 2), and with the collar depressed, pull the air line out of the fitting (step 3).

To reconnect, push the air line into the fitting and pull to verify a robust connection.

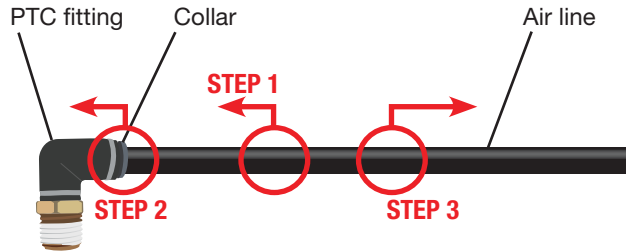

Tips

- To ensure a proper seal, cut off the end of the air line just beyond the witness mark before reinstalling in the fitting.
- If fitting is leaking at the threads, it may be necessary to remove and re-apply thread sealant on the threads and re-install 1 1/2 turns beyond finger tight.

FIXING AIR LEAKS ON BRAIDED STAINLESS STEEL AIR LINES

1. Disconnect the air line where it is leaking.
2. Check the mating surface on the fitting for burrs and remove if possible. If there are dings or indentations on the fitting mating surface, it may continue to leak and may need to be replaced.
3. To re-assemble, tighten the fitting one flat — or 1/6 of a full rotation — past finger tight.
4. Contact Air Lift customer service if the fitting continues to leak.

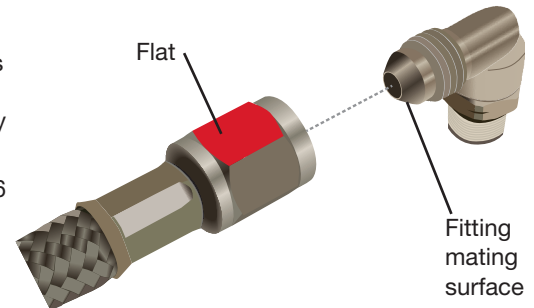

ADJUSTING AIR PRESSURE

The air springs should be adjusted for three factors: stability, level vehicle, ride comfort.

Stability

Stability translates into safety and should be the priority, meaning the driver may need to sacrifice a level and comfortable ride. Stability issues include roll control, bounce, dive during braking and sponginess. Tuning out these problems usually requires an increase in pressure.



Sway and
body roll

Level vehicle

Use air pressure to raise the end of the vehicle that is squatting back to its normal ride height. It may be necessary to apply more air pressure to one side if the load is uneven. If the vehicle has a single-path air control system, redistribute the load side to side.

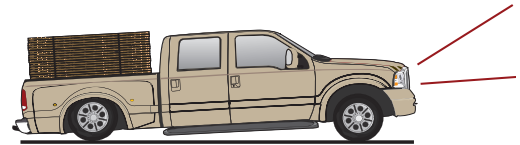

Bad headlight aim

Ride comfort

If the vehicle has a rough ride, it may be due to either too much air pressure or not enough. Experiment with different ride pressures, so long as it doesn't impact vehicle stability.

- If the vehicle feels like it is bottoming out, increase air pressure.
- If the headlights are aimed too high, try increasing air pressure in the rear air springs.
- When in doubt, add air.
- If the front of the vehicle dives while braking, increase the pressure in the front air springs, if equipped.

CHOOSING THE RIGHT ON-BOARD AIR COMPRESSOR SYSTEM

Add an on-board air compressor system to inflate and deflate the air springs with the touch of a button — from inside of the vehicle or outside (wireless systems).

- For convenient, on-the-go control of the air springs, add an Air Lift on-board air compressor system.
- Air Lift on-board air compressor systems eliminate the search for gas stations that have a working compressor, saving time, energy and money.
- All systems include a compressor, controller and all parts needed for easy installation.

1. Choose single- or dual-path inflation

2. Choose wireless or analog or automatic control

- **Wireless:** Control the air springs from inside or outside the vehicle. Easiest installation — no wires or hoses to the cab.
- **Automatic:** Air spring pressure is automatically adjusted based on ride height.
- **Analog:** In-cab control of the air springs. Economically priced.

3. Choose heavy- or standard-duty compressor

- **Standard duty:** A standard-duty compressor will work well for most customers who use their system on an intermittent basis.
- **Heavy duty:** For daily use, consider the heavy-duty compressor — it inflates faster and more quietly than the standard compressor.

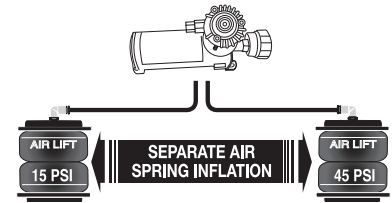

Dual-path systems: Air springs are controlled separately to allow for different air pressure from side to side. Perfect for uneven or top-heavy loads.

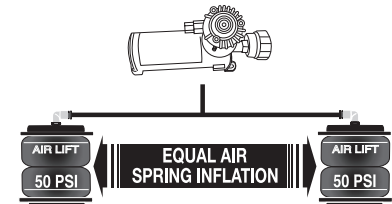

Single-path systems: Two springs will inflate at the same time. Good for loads that are evenly distributed from left to right.

ON-BOARD AIR COMPRESSOR SYSTEMS

WIRELESS CONTROL



Wireless**ONE**™

No wires or hoses to the inside of the cab

Single Path **P/N 25870**



Wireless**AIR**™

Premium system for independent control of each side

Dual Path **P/N 72000**

AUTOMATIC LOAD LEVELING



Smart**Air**™ II

Level every time

Single Path **P/N 25490**

Dual Path **P/N 25491**

ANALOG LOAD LEVELING



Load**Controller**™

Analog in-cab control

Single Path

SD **P/N 25850**

HD **P/N 25854**

Dual Path

SD **P/N 25852**

HD **P/N 25856**

Learn more about Air Lift on-board air compressor systems at airliftcompany.com

TROUBLESHOOTING GUIDE

| PROBLEM | CAUSE | SOLUTION |
|--|---|--|
| System won't maintain pressure overnight | Improperly installed air line, air line has holes or cracks, hole in air spring | Leak test all air line connections, threaded connections (if equipped), and all fittings in the control system (if equipped). Contact customer service regarding air spring failure. |
| Air spring or air line leak | Fitting seal or air line is compromised | Check to make sure air lines are seated in the fittings. Inspect fittings with soapy water. Trim hose or re-seal fitting. Ensure lines are cut straight. |
| One or more air springs won't inflate | Kink or fold in the air line, control system malfunction, inflation valve plugged | Replace any air line that has been kinked. Check control system function by disconnecting an air line, operating the system and checking for air pressure. |

FREQUENTLY ASKED QUESTIONS

Q. Will installing air springs increase the weight ratings of a vehicle?

No. Adding air springs will not change the gross vehicle weight rating (GVWR) of a vehicle. Exceeding the GVWR is dangerous and voids the Air Lift warranty.

Q. Is it necessary to keep air in the air springs at all times and how much pressure will they need?

The recommended minimum air pressure is 5 PSI (.34BAR) for all air springs. This helps the air spring maintain its shape and, on some kits, prevents bottoming out.

Q. Is it necessary to add a compressor system to the air springs?

No. Air pressure can be adjusted with any

type of compressor as long as it can produce sufficient pressure to service the air springs. Even a bicycle tire pump can be used.

Q. How long should air springs last?

If the air springs are properly installed and maintained they should last indefinitely.

Q. Will raising the vehicle on a hoist for service work damage the air springs?

No. For short-term service work such as tire rotation or oil changes, the vehicle can be lifted on a frame hoist with the air springs set to their minimum pressure. However, if the vehicle will be on the hoist for a prolonged period of time, support the axle with jack stands in order to take the tension off of the air springs.



LIMITED WARRANTY AND RETURN POLICY

Air Lift Company provides a limited lifetime warranty to the original purchaser of its Load Support products, that the products will be free from defects in workmanship and materials when used on cars and trucks as specified by Air Lift Company and under normal operating

conditions, subject to the requirements and exclusions set forth in the full Limited Warranty and Return Policy that is available online at www.airliftcompany.com/warranty.

For additional warranty information contact Air Lift Company customer service.

REPLACEMENT PART INFORMATION

If replacement parts are needed, contact the local dealer or call Air Lift customer service at **(800) 248-0892**. Most parts are immediately available and can be shipped the same day.

Contact Air Lift Company customer service first if:

- Parts are missing from the kit.
- Need technical assistance on installation or operation.
- Broken or defective parts in the kit.
- Wrong parts in the kit.
- Have a warranty claim or question.

Contact the retailer where the kit was purchased:

- If it is necessary to return or exchange the kit for any reason.
- If there is a problem with shipping if shipped from the retailer.
- If there is a problem with the price.

CONTACT INFORMATION

Mailing address P.O. Box 80167
Lansing, MI 48908-0167

Shipping address for returns 2727 Snow Road
Lansing, MI 48917

Phone Toll free: (800) 248-0892
International: (517) 322-2144

Email service@airliftcompany.com

Web address www.airliftcompany.com



Need Help?

Contact Customer Service
(800) 248-0892
service@airliftcompany.com

Air Lift Company
2727 Snow Road
Lansing, MI 48908-0167

AD-938 • (011803) • ERN 8875 • JJC-0318 • Printed in the USA

California: ⚠️WARNING: Cancer and Reproductive Harm – www.P65Warnings.ca.gov

*Air Lift has the answer to squat
with more than 450 vehicle applications!
Go to AirLiftCompany.com to learn more
and meet the Lumberman.*

