



A M C R E S T

**Amcrest IP3M-956W / IP3M-956B
3MP ProHD WiFi Vandal Dome Camera
User Manual**

**Version 1.0.4
Revised April 9th, 2019**

Contents

Welcome.....	3
Important Security Warning	3
Important Safeguards and Warnings.....	3
1 Features and Specifications	4
1.1 Overview	4
1.2 Features	4
2 Device Overview	5
3 Connection & Installation	5
3.1 Connection Guide.....	5
3.2 Installation Guide	5
3.3 MicroSD Card Installation Guide	6
4 Camera Access Setup.....	7
4.1 Default Username and Password.....	7
4.2 How to Setup the Camera	7
4.3. App Setup.....	7
4.4 Desktop Access Setup	14
4.5 Amcrest Cloud Desktop Setup	67
4.6 Web Access Setup (AmcrestView.com)	67
5 Operation and Interface	67
5.1. Live	68
5.2 Playback	70
5.4 Setup	72
5.5 Alarm.....	113
6. FAQs/Troubleshooting.....	115
Glossary of Terms	117
FCC Statement	118
IC Warning Statement	118
Appendix A: Toxic or Hazardous Materials or Elements.....	119

Welcome

Thank you for purchasing an Amcrest camera!

Here you can find information about the camera's features and functions, as well as information to aid in troubleshooting.

Many of the setup and installation sections below have corresponding videos on YouTube  To access the setup videos, please go to <http://amcrest.com/videos>

For access to the quick start guide and other support information, go to <http://amcrest.com/support>
To contact Amcrest support, please do one of the following:

- Visit <http://amcrest.com/contacts> and use the email form
- Call Amcrest Support using one of the following numbers
Toll Free: (888) 212-7538
International Callers (Outside of US): +1-713-893-8956
USA: +1-713-893-8956
Canada: 437-888-0177
UK: 203-769-2757
- Email Amcrest Customer Support support@amcrest.com

Important Security Warning

To keep your Amcrest camera secure and prevent unauthorized access, please make sure to follow the steps below:



- Always make sure that your camera has the latest firmware as listed on www.amcrest.com/firmware-subscribe
- Never use the default password for your camera. Always ensure that your password is at least 810 characters long and contains a combination of lowercase characters, uppercase characters as well as numbers.

Important Safeguards and Warnings

1. Electrical Safety

All installation and operation should conform to your local electrical safety codes.

The product must be grounded to reduce the risk of electric shock.

We assume no liability or responsibility for any fires or electrical shock caused by improper handling or installation.

2. Transportation Security

Heavy stress, violent vibrations, and excess moisture should not occur during transportation, storage, and installation of the device.

3. Installation

Handle the device with care. Keep the device right side up.

Do not apply power to the camera before completing installation.

Do not place objects on top of the camera.

4. Repair Professionals

All the examination and repair work should be done by qualified service engineers.

We are not liable for any problems caused by unauthorized modifications or user-attempted repair.

5. Environment

The camera should be kept in a cool, dry place away from direct sunlight, flammable materials, explosive substances, etc.

This product should be transported, stored, and used only in the specified environments as stated above. Do not aim the camera at a strong light source, as it may cause overexposure of the picture, and may affect the longevity of the camera's sensors.

Ensure that the camera is in a well-ventilated area to prevent overheating.

6. Operation and Maintenance

Do not touch the camera sensor or lens directly.

To clean dust or dirt off the lens, use an air blower or a microfiber cloth.

7. Accessories

Be sure to use only the accessories recommended by manufacturer.

Before installation, please open the package and check to ensure that all the components are present. Contact the retailer that you purchased from, or Amcrest directly if anything is broken or missing in the package.

1 Features and Specifications

1.1 Overview

Amcrest cameras are an excellent digital surveillance product that can be useful to a wide variety of users. This camera connects to any router and uses an internet connection to allow the user to access all of its functionality from many internet connected devices. It's easy to use and can be set up in a relatively small amount of time. It has various functions such as recording, playback, and monitoring functionality and it synchronizes audio and video by default.

This camera adopts a high-quality design to achieve high levels of reliability and security. It can be configured to work locally, as well as on a network. This camera works using an Ethernet/Wi-Fi connection and interfaces with most networks through the Ethernet port of your router.

1.2 Features

The camera has the following features:

- **Network Access**

The camera connects to a wide variety of routers to connect to the internet. Once setup, the camera can be accessed remotely from a wide variety of internet connected devices, including PCs, iPhones, iPads, Android tablets, and Android phones.

- **Cloud Storage Functionality**

The camera can record video and audio streams to the Amcrest Cloud service to enable long-term storage for recordings. Amcrest Cloud also allows the user to easily find and download recorded video for playback from any internet connected PC or Mac computer.

- **Advanced Network Protocol Support**

The camera is UPnP compatible, and includes functionality for use with PPPoE, DDNS, and other protocols to allow remote and local connection with a large variety of network hardware.

Note: There may be slight differences in functionality due to the existence of different product series.

IMPORTANT: Due to specific hardware limitations within your camera it is important to note that these devices will not be able to automatically pan/tilt or pivot in either the app or via the web UI on a computer. For this reason, it is imperative to make sure to mount the cameras properly and position them as efficiently as you can to the areas you wish to monitor. All positioning actions to the camera will have to be performed manually.

2 Device Overview

The image below shows the structure of the camera:

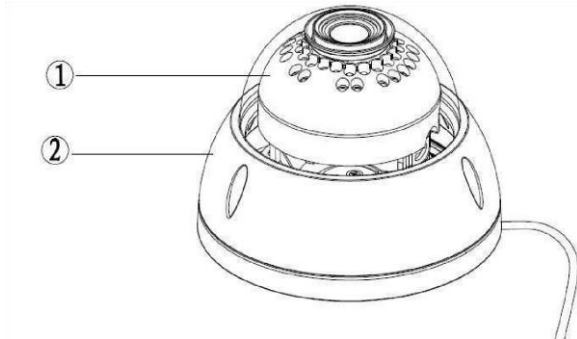

The images below show the dimensions for the camera. The measurements are in millimeters (mm):

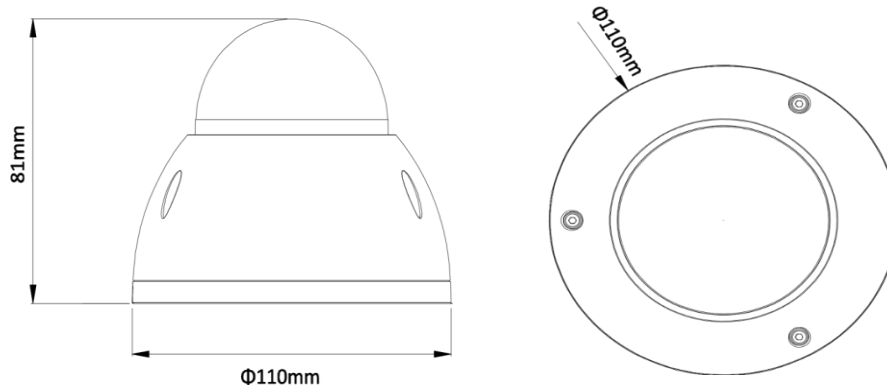

To access the reset button and to adjust the camera angle, use a Torx/Hex wrench to open the camera assembly by removing the 3 screws. For reference, a Torx/Hex screwdriver tip looks like this:



3 Connection & Installation

This section provides information about the connection and installation of your camera.

3.1 Connection Guide

The camera initially should be connected via the following method:

- WiFi Connection
- Ethernet Connection

For more information on how to connect your camera, refer to *section 4, Camera Access Setup*.

3.2 Installation Guide

To install the camera on a ceiling or wall, please reference the below diagram as well as the steps:

Note: Prior to installation, please ensure that the installation environment can support at least 3x the weight of the camera + bracket.

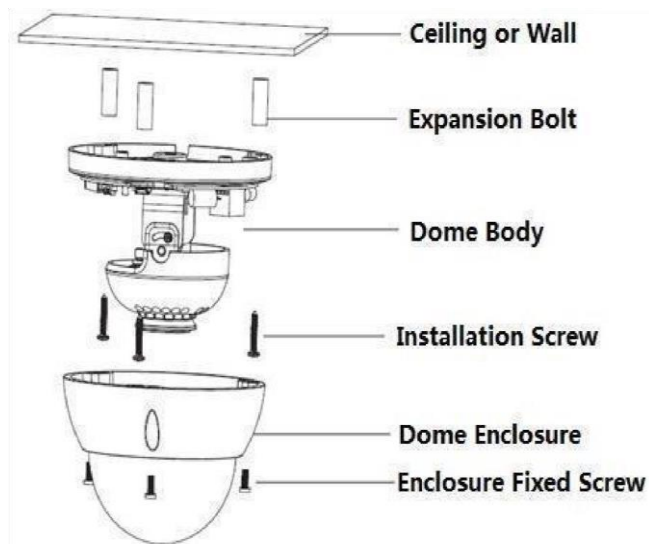

Note: Due to specific hardware limitations within your camera it is important to note that these devices will **not** be able to automatically/remotely pan/tilt or pivot in either the app or via the web UI on a computer. For this reason, it is imperative to make sure to mount the cameras properly and position them as efficiently as you can to the areas you wish to monitor. All positioning actions to the camera will have to be performed manually.

To install the camera onto a wall, follow the steps below:

1. Connect the WiFi antenna to the antenna port of the camera.
2. Use a Torx/Hex wrench (included) to open the dome enclosure by unfastening the three inner hex screws on enclosure.
3. Place the installation sticker on the wall or ceiling surface that you wish to mount your camera.
4. Using the X's on the installation sticker, drill 3 holes to allow for the insertion of the included expansion bolts.
5. If the camera's cable will be exiting through the wall or ceiling surface, please be sure to drill an exit hole and pull the cable through.
6. If the camera's cable will be exiting through the side of the camera, route the cable through the U-shaped channel on the side of the enclosure.
7. Align the camera with the installation sticker, then line up the 3 screw holes in the camera pedestal to the three plastic expansion bolts on the installation surface. Put the three included screws through the camera then insert them into the expansion bolts firmly.
8. Adjust the camera in the position that you want it to be in, then reattach the dome body to the base of the camera. Note: Range of lens: vertical ($0^{\circ}\sim+65^{\circ}$), horizontal ($0^{\circ}\sim+355^{\circ}$). When adjusting the camera into position, please ensure that the camera's enclosure does not block the image or cause reflection of IR light.

3.3 MicroSD Card Installation Guide

To install a microSD card into your camera, please refer to the step by step guide below:

Note: You will need to access the camera's motherboard to insert the microSD card.

1. Remove the lens cover for the camera with the supplied wrench tool to access the motherboard.
2. Locate the provided microSD card slot on the motherboard and slide the clasp back to open.
3. Place the microSD card, into the provided microSD card slot gold pins down and close the clasp.
4. Slide the clasp forward to secure the microSD card to the pins and secure the clasp.

4 Camera Access Setup

This section of the guide will provide the user with information on how to setup access to the camera through any of the following methods.

4.1 Default Username and Password

To login to the system for the first time, use one of the following default username/password combinations. Once you've successfully logged in, it is highly recommended to change the password for security reasons.

Username: admin

Password: admin

Note: Logging in for the first time will prompt the user to change the password to the admin account.

4.2 How to Setup the Camera

To make your experience with your camera easy and simple, we've provided multiple ways to set up, view, and operate your camera depending on your needs. Please follow the instructions on this page to set up your camera in the way that works best for you.

4.2.1 Setting up Your Camera for the First Time

If you are setting up your camera for the first time, or you are setting up your camera for mobile viewing, please follow the instructions as outlined on section 4.3. Using the Amcrest View app on your smartphone or tablet, you can view your camera live from anywhere, and access features such as taking snapshots, creating recordings, and more.

4.2.1 For Configuring Advanced Settings On Your Camera

If you would like to configure your camera to enable advanced features such as motion direction, e-mail alerts, FTP, image adjustments, scheduling and more, please follow the instructions as outlined on section 4.4 (Desktop Access).

4.2.3 For Cloud Storage and Playback

Amcrest Cloud is our optional cloud storage and playback service which allows you to access recorded footage from any device. We offer 4 hours of free storage for your first camera. Please follow the instructions as outlined on section 4.5 (Cloud Access) to sign up for our Amcrest Cloud service and get 4 hours of free storage.

4.2.4 For Quick Web Access to Your Cameras

AmcrestView.com is a web portal that allows you to view your cameras and recordings quickly and easily from anywhere in the world using a web browser. Use AmcrestView.com if you need to simply check-in at a moment's notice. If you would like to use AmcrestView.com, please follow the instructions outlined on section 4.6 (Web Access).

4.3. App Setup

Amcrest cameras can be used on your mobile device using the following apps:

- Amcrest Cloud
- Amcrest View Pro

Both apps are free and available in the App Store and Google Play store. Please note, each app requires an iOS 6.0 or later version. Android will require a 3.0 or later version OS to run these apps.

For purposes of this guide, we will use iOS, though both apps. The App Interface may differ slightly from the screenshots below as updates are released. Below, you'll find instructions on how to set up your camera up on the Amcrest cloud app as well as the Amcrest View Pro app.

4.3.1. Amcrest Cloud App Setup

Amcrest Cloud allows you to access your device from anywhere in the world. Please note, you will need an Amcrest Cloud account to proceed with Amcrest Cloud app setup. You can register for a cloud account in the Amcrest Cloud app or from the Amcrest Cloud website at amcrestcloud.com

- Please make sure your camera is plugged into a power source and your Ethernet cable is connected from the camera to your router.
- Make sure your camera and mobile device are on the same network during setup.
- To ensure the camera connects to the cloud, a reboot of your camera is recommended.

To add your camera onto the Amcrest Cloud app, follow these steps:

1. Download and open the Amcrest Cloud app from the App Store or Play Store



Note: Connect your mobile device to the same network that your camera is on.

2. Register for an Amcrest Cloud account. To register click on **Sign Up** and fill out the form to complete registration.

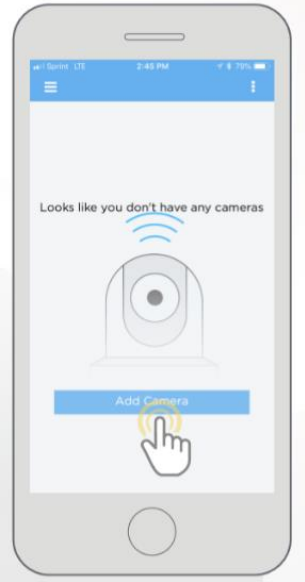
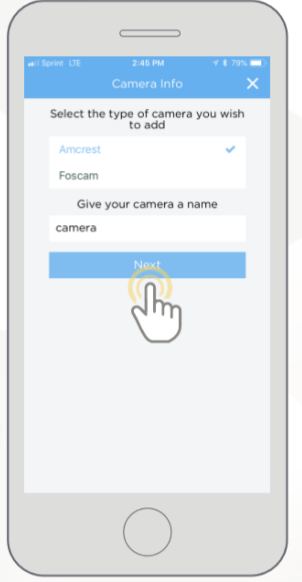
	
<p>3. Tap on Add Camera</p>	<p>4. Give your camera a name (Ex. Garage, Living Room, Kitchen, etc.) and tap Next to continue.</p>

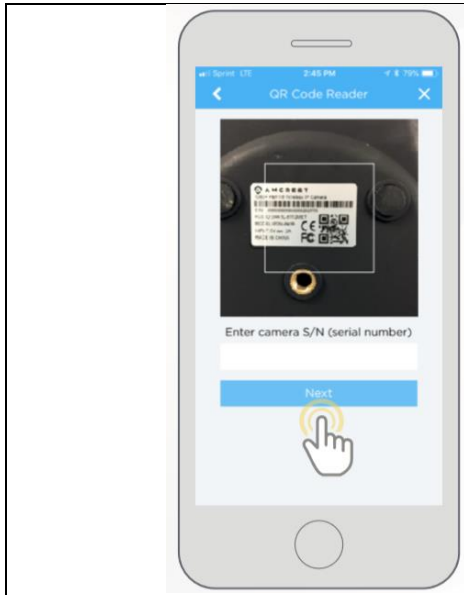

5. Scan the QR code  on the back/side/bottom of the camera or manually enter the camera's serial number in the **Enter camera S/N (serial number)** field. Press **Next** to continue.

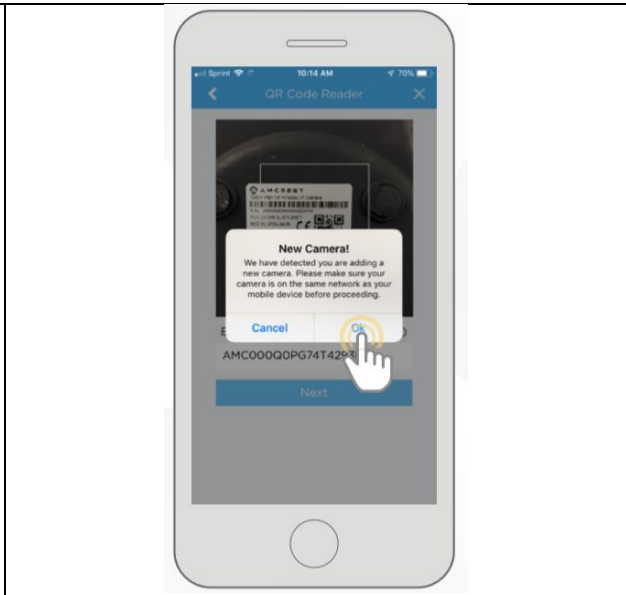

6. If you are adding a new camera that does not have a set password the app will automatically detect that a new camera is being added. Tap **OK** to proceed.

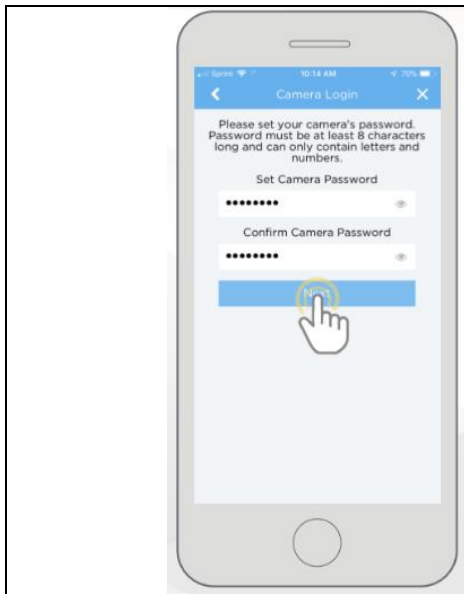

7. Set a new password for your camera. The password must be between 8 to 32 characters long and contain only letters and numbers. When you have finished setting the password for your camera, enter the password again in the **Confirm Camera Password** section. Tap **Next** to continue.

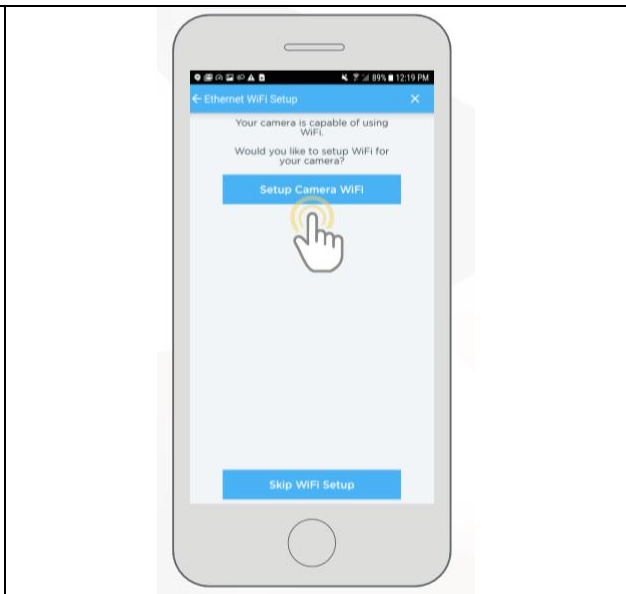

8. If you are connecting a WiFi camera to the Amcrest Cloud and would like to enable WiFi via the Ethernet WiFi Setup method, tap **Setup Camera WiFi**. Additionally, if you would like to skip the WiFi process and have your WiFi camera running solely as a wired device, tap on **Skip WiFi Setup**.

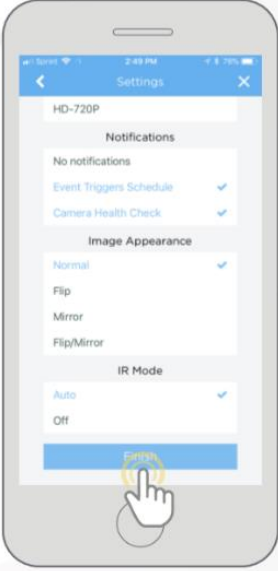
	
<p>9. If you wish to enable WiFi on your WiFi camera, tap Scan to scan and select your WiFi network from the WiFi Network List. Enter the password for your WiFi network onto the Password field. When the WiFi password has been entered, tap Next to continue.</p>	<p>10. Confirm and adjust any needed settings for your camera. When all settings have been confirmed, tap Finish.</p>

Note: For Android 8.0 and above users, you will have to enable location permissions to be able to scan for your WiFi network. For more information about the Amcrest Cloud app and its features, visit amcrest.com/support

4.3.2. Amcrest View Pro Setup

- Make sure your camera is plugged into a power source and your Ethernet cable is connected from the camera to your router.
- Make sure your camera and mobile device are on the same network during setup.
- Download and open the Amcrest View Pro app from the App Store or Play Store.



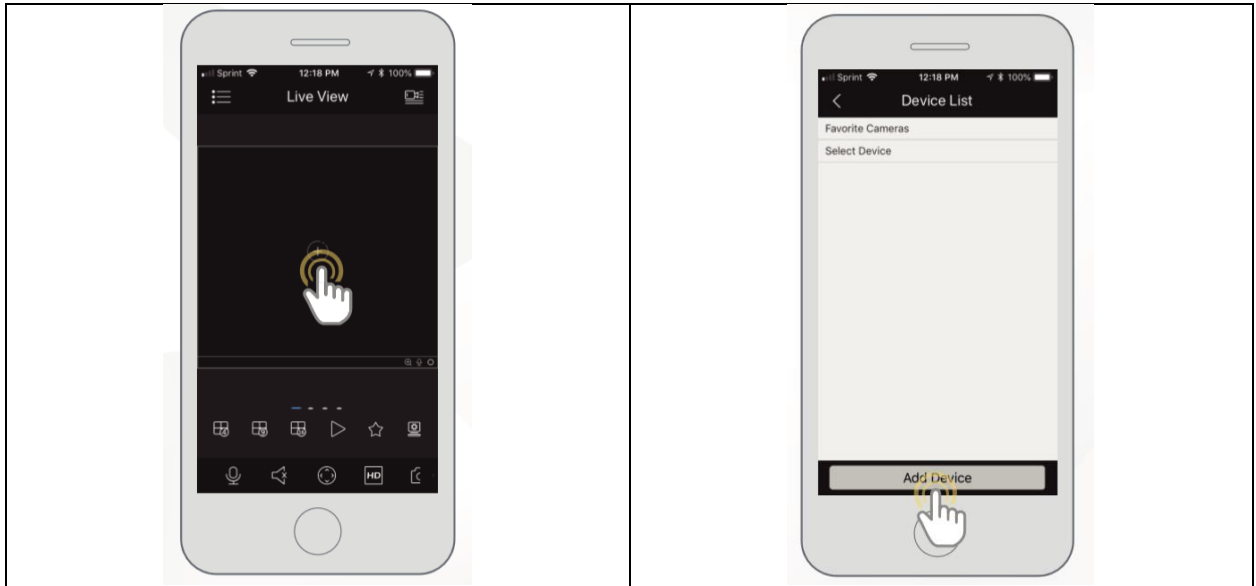

1. Open the app and tap on the + symbol in the middle of the screen to begin adding your WiFi device.

2. Tap on **Add Device** to add a new device to your app.

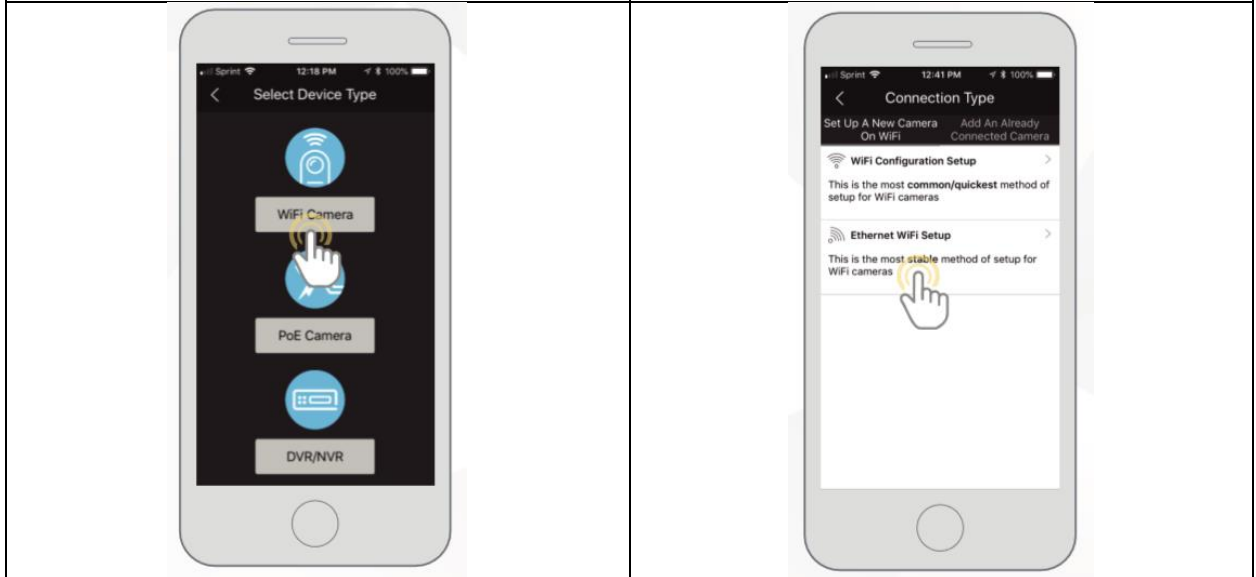

3. Tap on **WiFi Camera**

4. Select your connection type, in this case, select the left tab **Set Up A New Camera On WiFi** or **Connect New Device** (on Android) to begin adding the device to the app. Tap **Ethernet WiFi Setup** to continue.

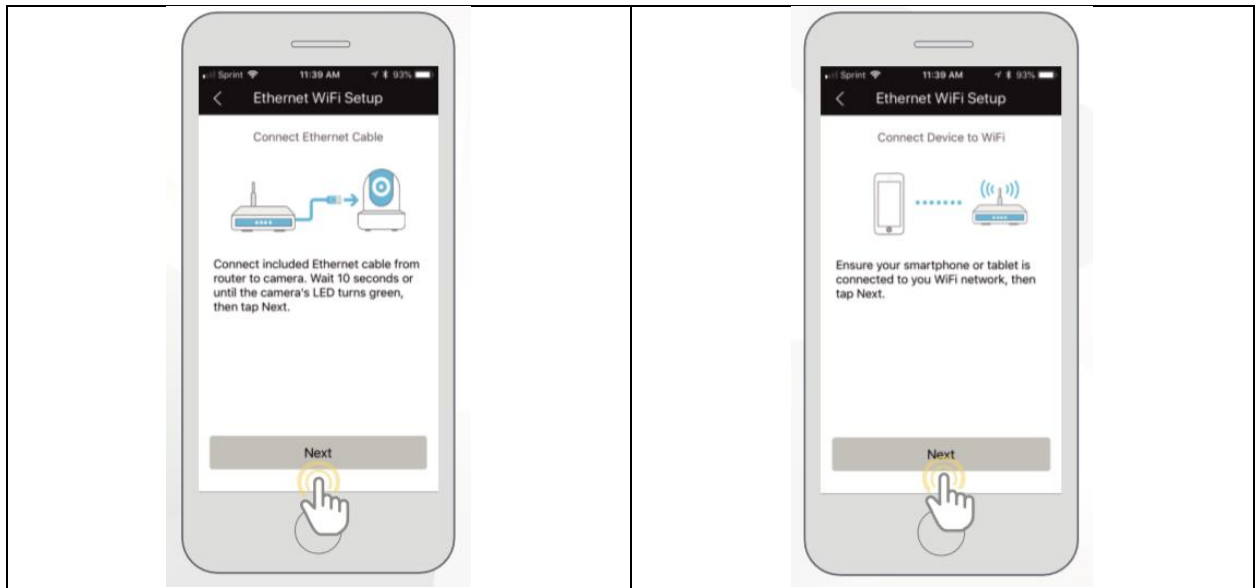

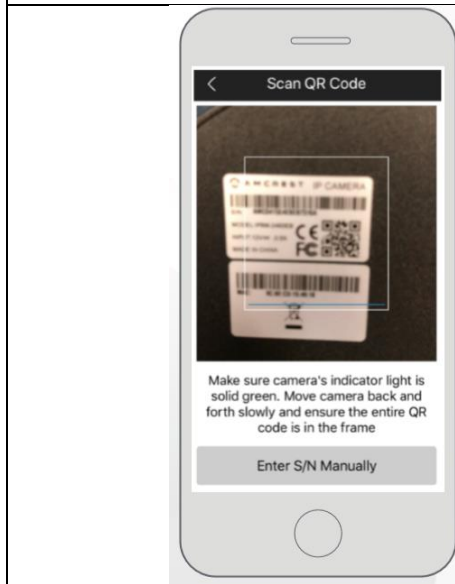

5. Ensure an Ethernet cable is connected from the router to the camera and the included power adapter is connected to the device. Allow the device to initialize (if applicable) and press **Next** to continue.

6. Ensure your smartphone or tablet is connected to the same WiFi network as your camera. Tap **Next** to continue.

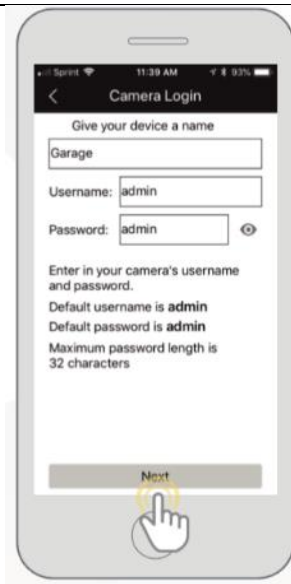

7. Scan the QR code  on the back/side/bottom of the camera or manually enter the camera's serial number into the **Enter camera S/N (serial number)** field. Press **Next** to continue.



8. Give the camera a name (e.g. Garage, Kitchen, Living Room, etc.) and provide the username and password for your camera. The default username and will be **admin**. Tap **Next** to continue.
Note: You can tap on the  icon to verify the password.

Note: Android users, tap on **Scan QR Code** to access the QR code reader.

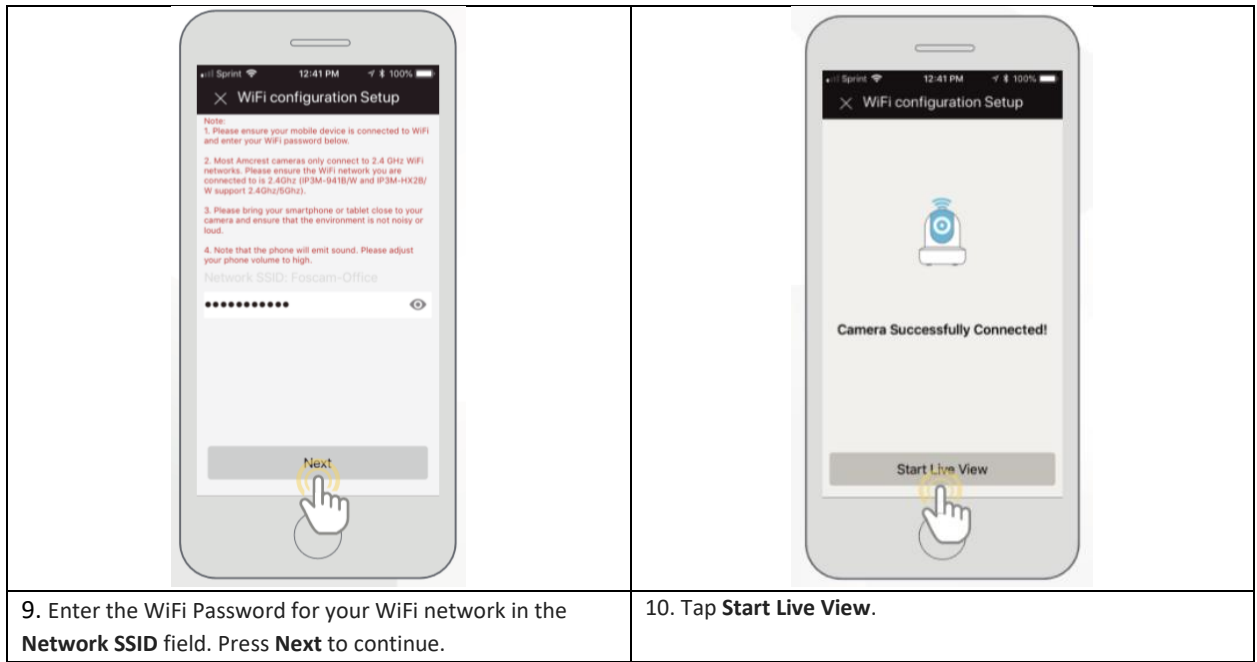

Note: For Android 8.0 and above users, you will need to enable location permissions to be able to locate and scan for your WiFi network. For more information on how to locate an SSID visit: amcrest.com/androidP

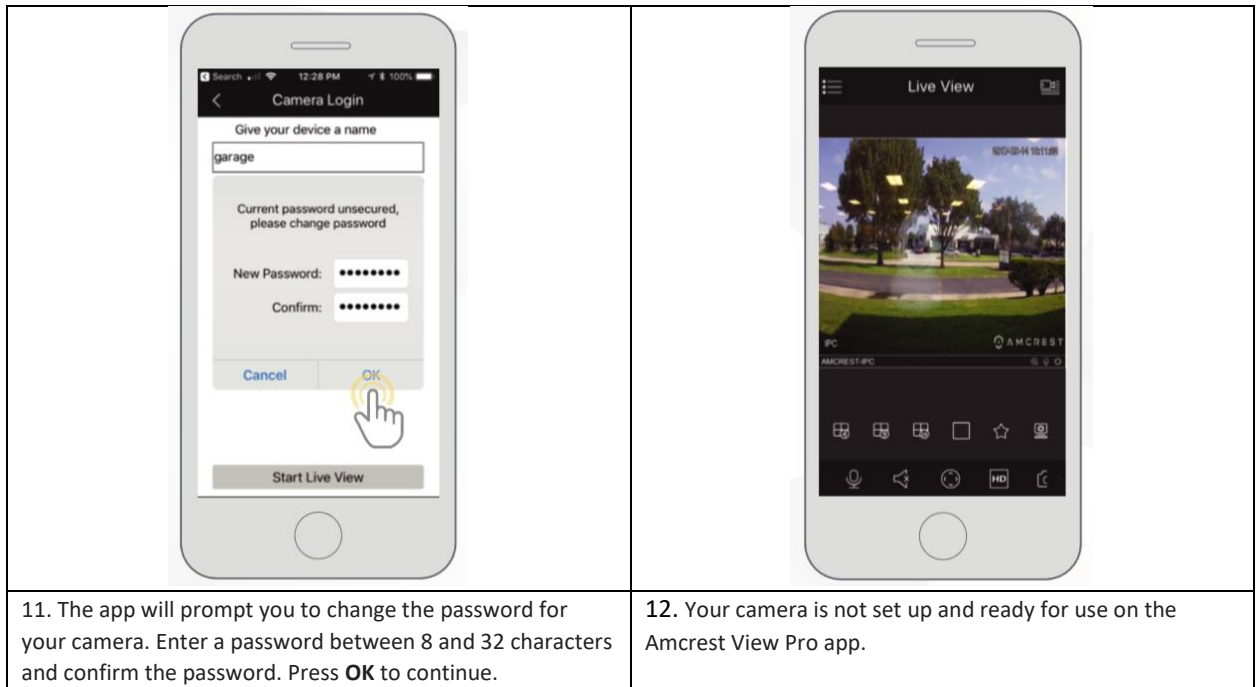

For more information about Amcrest View Pro and its functionalities visit amcrest.com/support

For more information on alternative setup methods for your camera in the Amcrest View Pro app visit the following links:
IP/Domain/DDNS App Setup: Used to establish a connection without using P2P. For more information on this setup method visit, amcrest.com/IPDomainDDNSsetup

WiFi Configuration Setup: Used as a secondary option for establishing a WiFi connection to a WiFi camera. For more information on this setup method visit, amcrest.com/wificonfig

P2P Setup: Used for setting up already connected devices to the Amcrest View Pro app. For more information on this setup method visit, amcrest.com/p2psetup

4.4 Desktop Access Setup

NPAPI plugins have been recently depreciated by most mainstream web browsers such as Google Chrome, Outlook, and Firefox. Amcrest is pushing forward to create new and diverse ways for you to more easily access your devices from anywhere at any time. This document was created to provide a general overview and understanding on how to best access your device from your computer.

Amcrest Surveillance Pro

Amcrest Surveillance Pro is an abbreviation for Professional Surveillance System. This software **the most stable and recommended method of accessing your devices from your computer**. It is a free software provided by Amcrest that can provide a means of accessing all your devices in one central location without the use of a plugin or web browser.

Note: Mac users, Amcrest Surveillance Pro currently functions as a 32-bit platform and may not be compatible with certain 64-bit Mac operating systems.

Installation

To install the Amcrest Surveillance Pro software on your computer, please visit amcrest.com/downloads In the **All Downloads** page you will notice separate sections for Mac OS and PC/Windows downloads for the free Amcrest Surveillance Pro software. Click on the option that applies to your computer's operating system to begin installing the software.

To install the software, double click the Amcrest_Surveillance_Pro_Setup.exe to begin the installation.

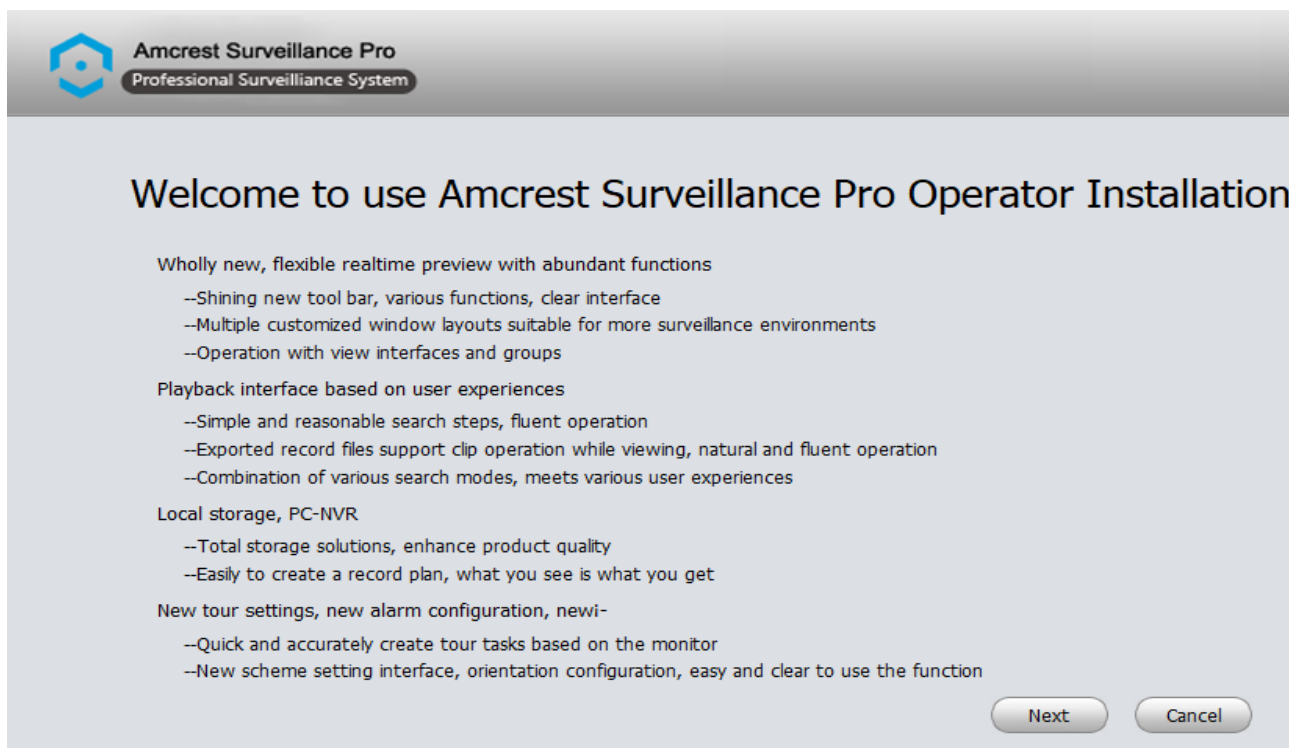

Click **Next** to continue. Please read the End-User License Agreement (“EULA”) carefully and click the **Accept** radio button when finished to agree. Once accepted, click the **Next** button to continue.

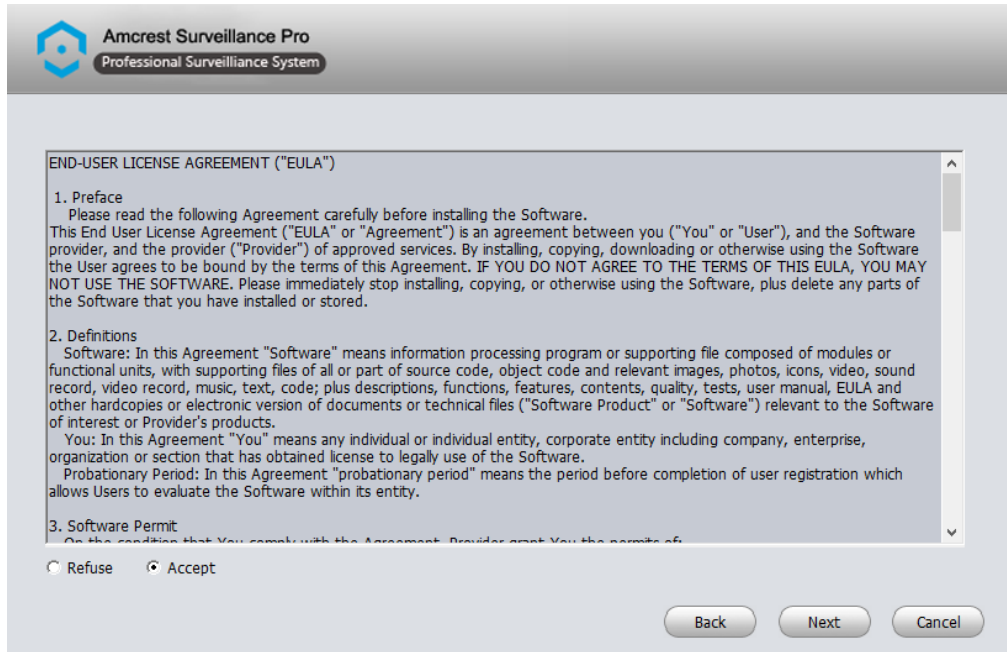

Select the functions that you want to install with the software. You can choose to bundle the PC-NVR function with the software. PC-NVR turns your computer into an NVR and will utilize your hard drive (HDD) on your PC to store and access recorded video. To proceed with the installation, click **Next**.

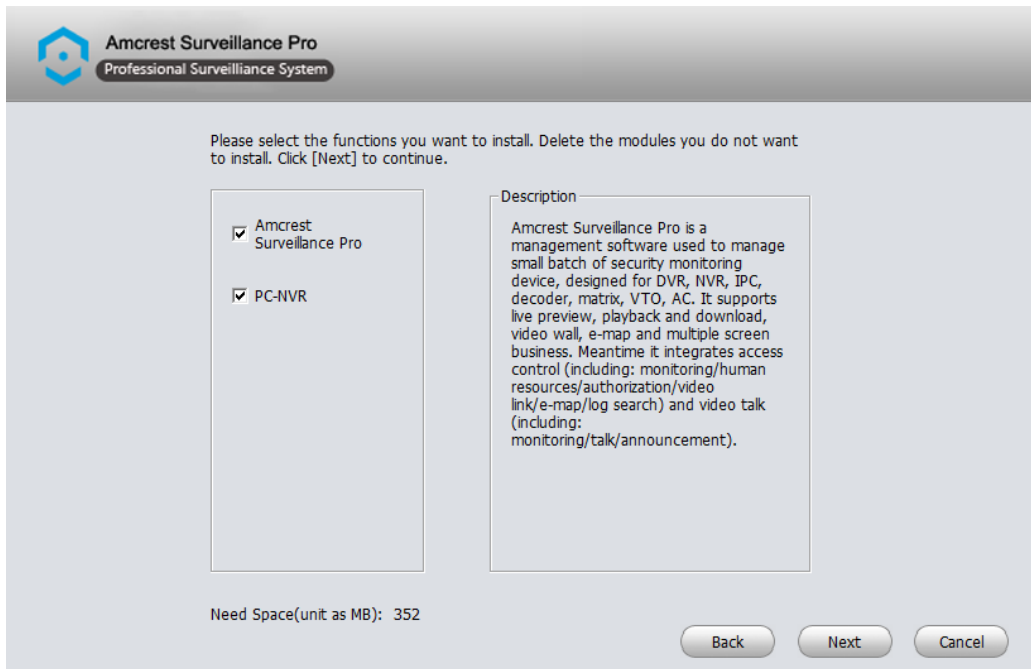

Select the destination folder in which you would like recorded files to be retained. To choose a folder, click on the **Browse** button and select the folder. Once a folder has been selected, click the **Install** button to begin installing the software on your computer.

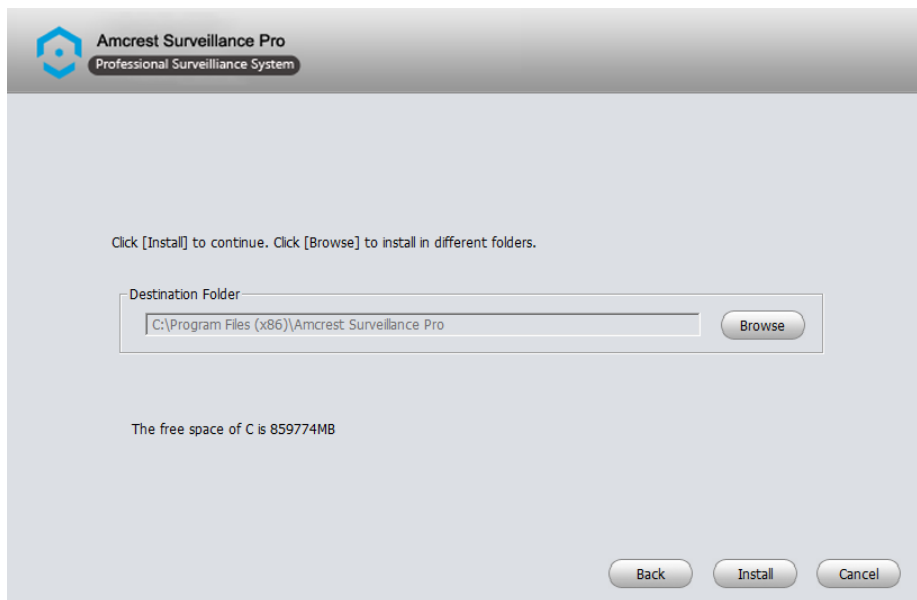

Once the software has finished installing you will see a few options. You will have the options to view the release note and run the Amcrest Surveillance Pro software. To view the release notes after pressing **Finish** select the **Release note** checkbox. To begin running the software directly after pressing finish, select the **Run Amcrest Surveillance Pro** checkbox. When complete, click the **Finish** button to proceed.

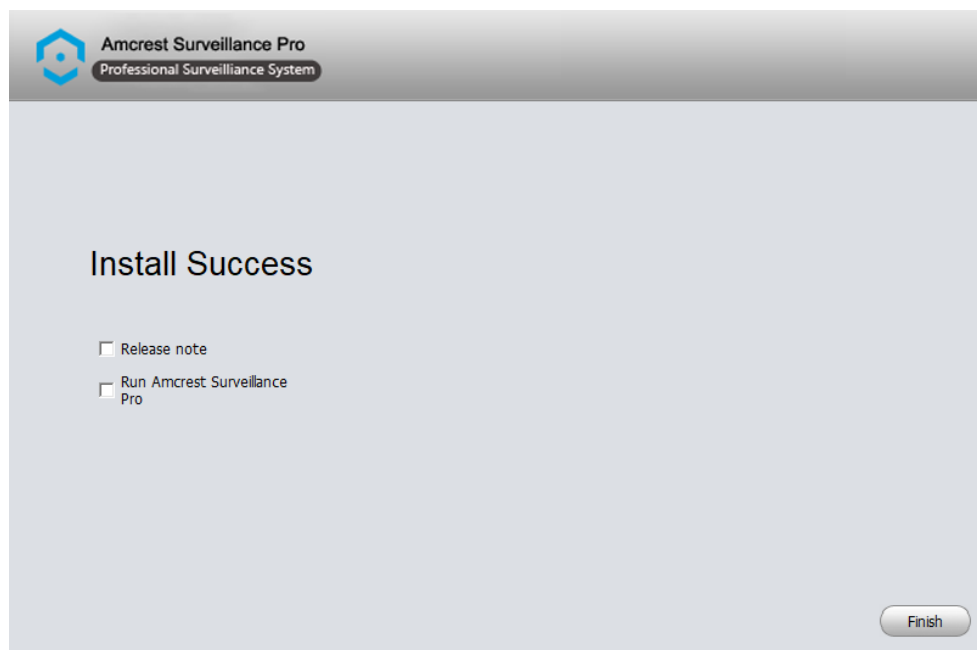

Setting a Password

After the installation of the Amcrest Surveillance Pro software you will need to set an administrator password. This password will be set password for the admin account on the software. When a valid password has been entered, confirm the password in the **Confirm Password** field and click **OK** to continue.

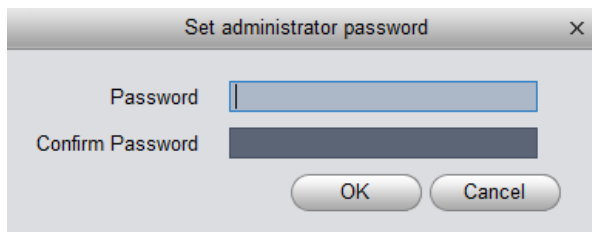

Type the created password into the **Password** field on the next screen and click **Login** to log into the software. If you do not wish to have to retype your password every time you log into the system, click on the **Remember Password** checkbox. If you wish to exit the software, click **Exit**.

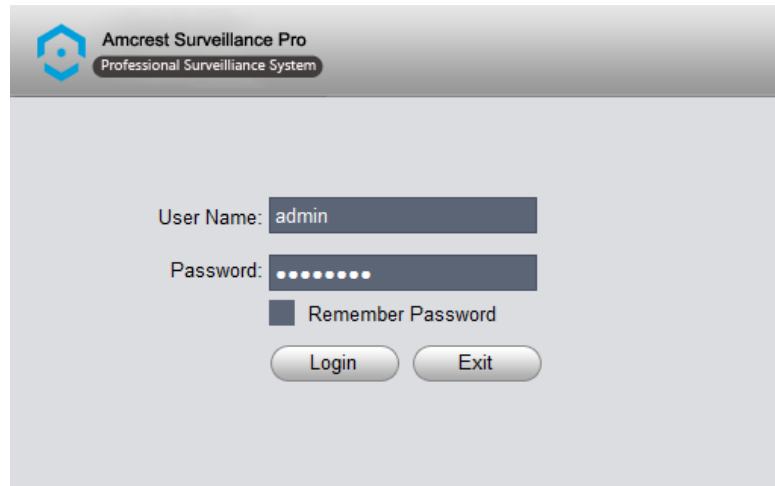

Main Interface Overview

When you first log into the software you will be taken to the main interface of the software.

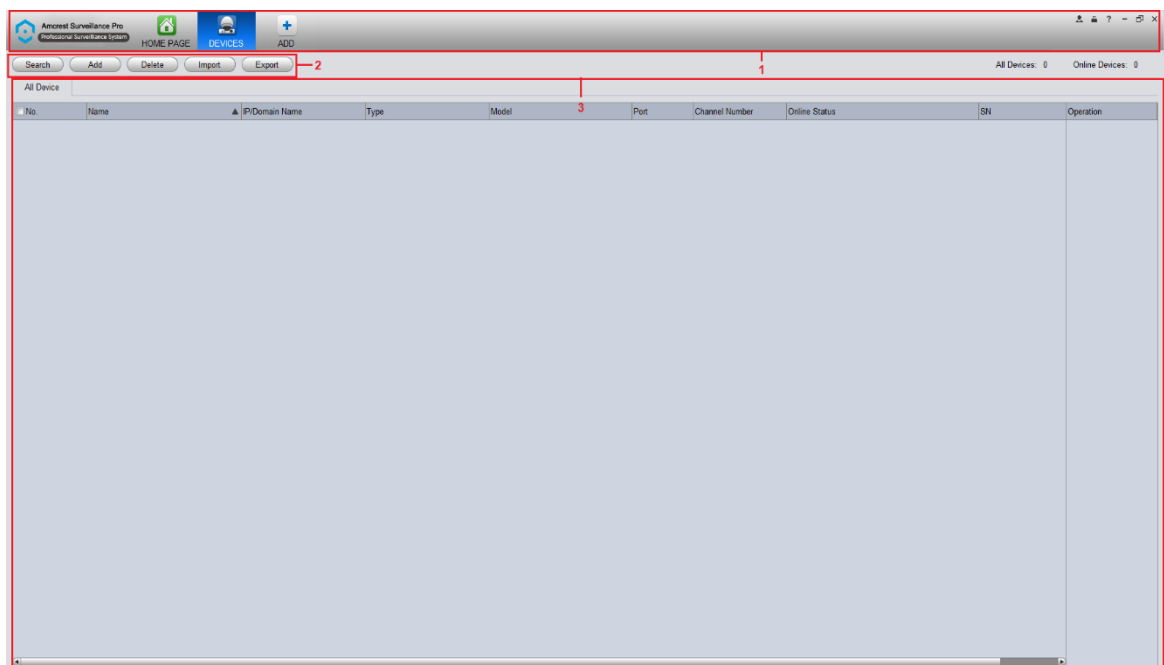

Below is a description of the items listed in this menu.

Menu	In this section you can view the home page icons and any currently open functions in the software. Click the Add button to add a function icon to the top pane.
Settings Menu	This menu allows you to Search, Add, Delete, or Import, and Export settings of devices connected to your network.
All Devices	This menu allows you to view all added devices associated with the software.

Adding Devices into Amcrest Surveillance Pro

To provide the highest efficiency and security when adding a device into the Amcrest Surveillance Pro software it is highly recommended to add the device using a direct IP address as opposed to using a P2P connection. Using a direct IP provides a direct connection to your device without the use of utilizing a P2P server.

Direct IP Connection

To begin adding a camera, you will need the IP address of the device. To obtain the IP address for your device, it is recommended to download the Amcrest IP Config tool. To get the Amcrest IP Config tool, go to amcrest.com/downloads and click on the IP Config software link for either PC/Windows or Mac OS. Launch the IP Config tool and locate the IP address for your device. The IP address will be listed in the **IP** field of the software.



No.	Type	Model	IP	TCP Port	HTTP Port	Subnet
1	IPC	IP2M-841B	10.0.27.213	37777	80	255.0.0.0

After locating the IP address in the Amcrest IP Config tool for the device, return to the Amcrest Surveillance Pro software and click on the **Add** button.

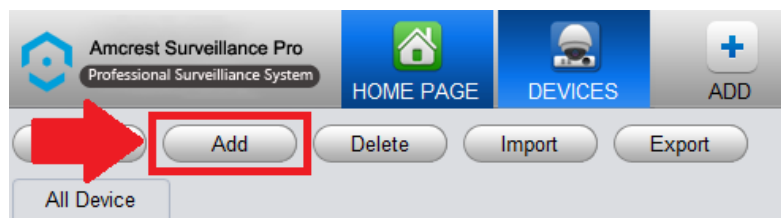

In the add menu, enter a name you would like to assign to your device. In this example, we are using “Front Door Camera”. Next, in the **Method to add** menu, use the default setting “**IP/Domain**”, then enter the IP address and port number of the device being added. As a reminder, the IP and port number of the device can be located in the IP Config software. The group name will then be applied as **Default Group**, then enter the user name and password for your device. If this is the first time using your device, the default username and password will be **admin**. Click the **Save and Continue** or **Add** buttons to proceed.

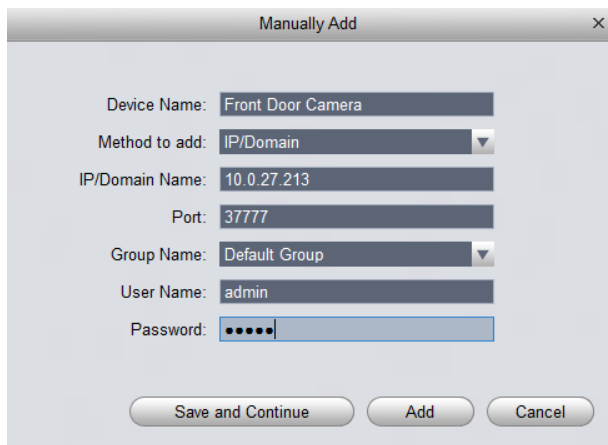

Manually Add dialog box with the following fields:



- Device Name: Front Door Camera
- Method to add: IP/Domain
- IP/Domain Name: 10.0.27.213
- Port: 37777
- Group Name: Default Group
- User Name: admin
- Password: [masked]

Buttons: Save and Continue, Add, Cancel

Once the device has been properly added the added device will appear in the **Device** menu.

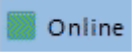

No.	Name	IP/Domain Name	Type	Model	Port	Channel Number	Online Status	SN	Operation
1	Front Door Camera	10.0.27.213	IPC	IP2M-841B	37777	1/0/1/1	Online (please change password)	AMC000G7802L56N53M	[Settings] [Refresh] [Close]

If the device is properly connected in the software, you will notice a  icon in the **Online Status** field. If the device is not connected properly, click on the online status will be red. To modify settings for your device, click on the  icon located in the **Operation** menu. This menu allows to rename the camera as well as change the port number, username, and password. To update the password, remove the default password and type the new password in this field. When done, click on **Save** to save the information for the device.



Modify Device dialog box with the following fields:

- Device Name: Front Door Camera
- Method to add: IP/Domain
- IP/Domain Name: 10.0.27.213
- Port: 37777
- Group Name: Default Group
- User Name: admin
- Password: [masked]

Buttons: Save, Cancel

A red arrow points to the **Save** button.

Setting a Device to a Static IP

For security purposes it is highly recommended to set the camera to a static IP address. Setting your device to a static IP will ensure the stability and the efficiency of your device while operating it in the Amcrest Surveillance Pro software. To set your device to a static IP, click on the **Home Page** icon and navigate to the **Device Config** menu.

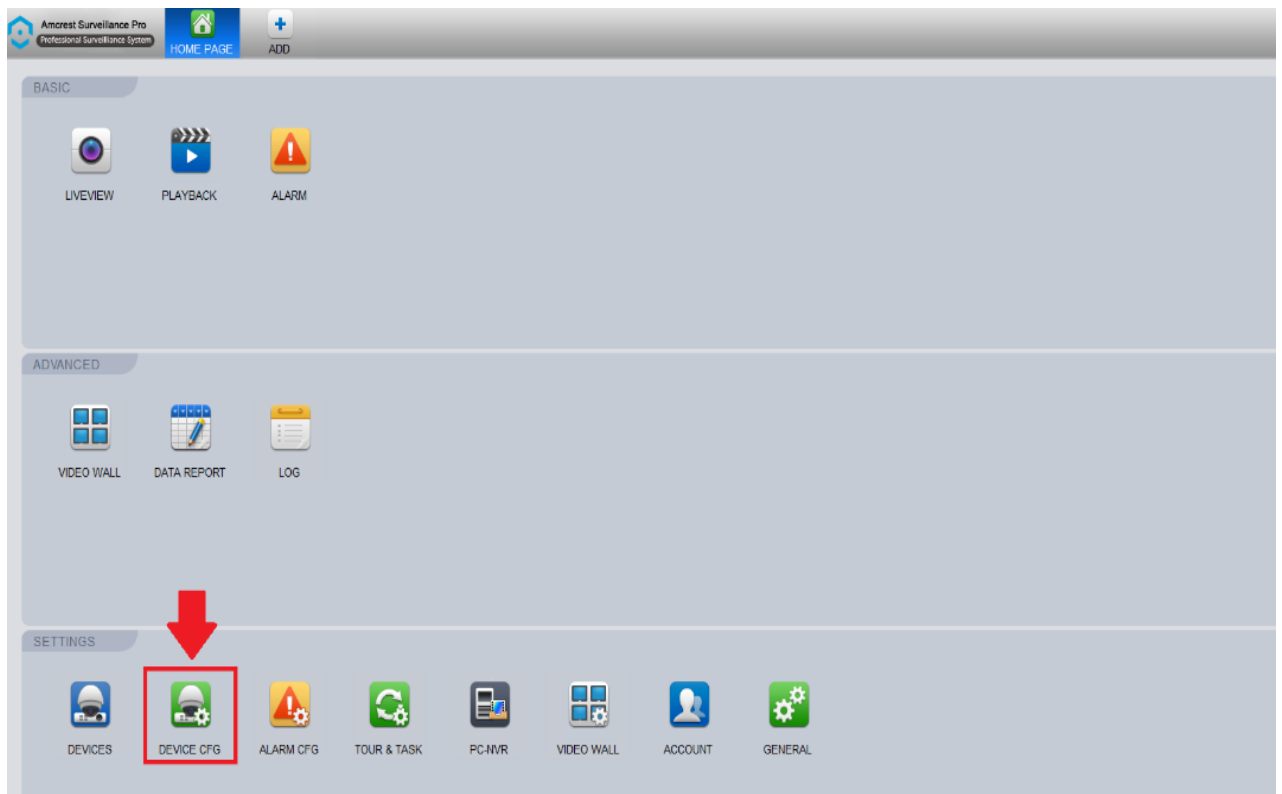

In the **Organizations** menu on the far left, click on the device you wish to modify. Then In the device configuration menu, under **General** click on the **Network** icon to access the network settings for your device.

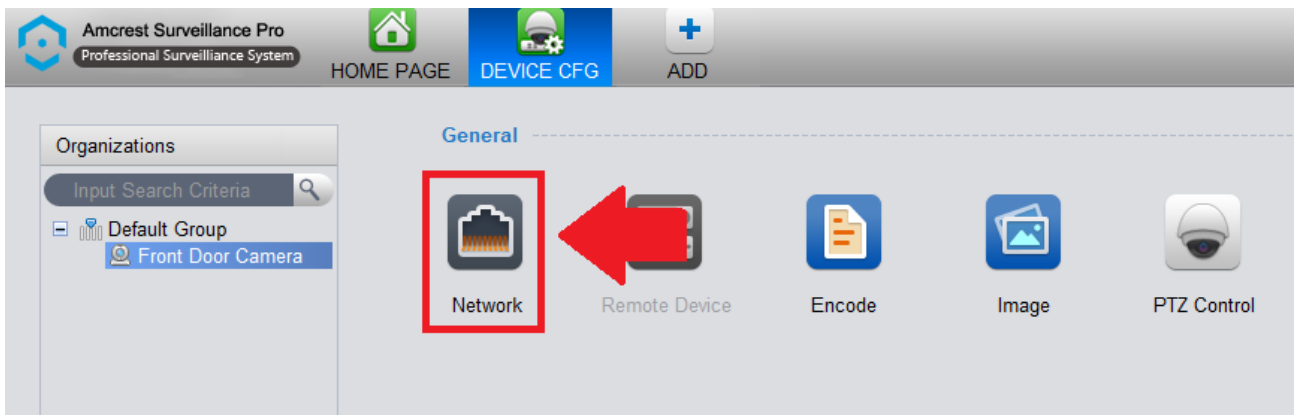

In the **Network Settings** menu, in the **Mode** section click on the **Static** radio button to set your device to a static IP. Click **Save** and **Apply** to apply the network settings to your device.

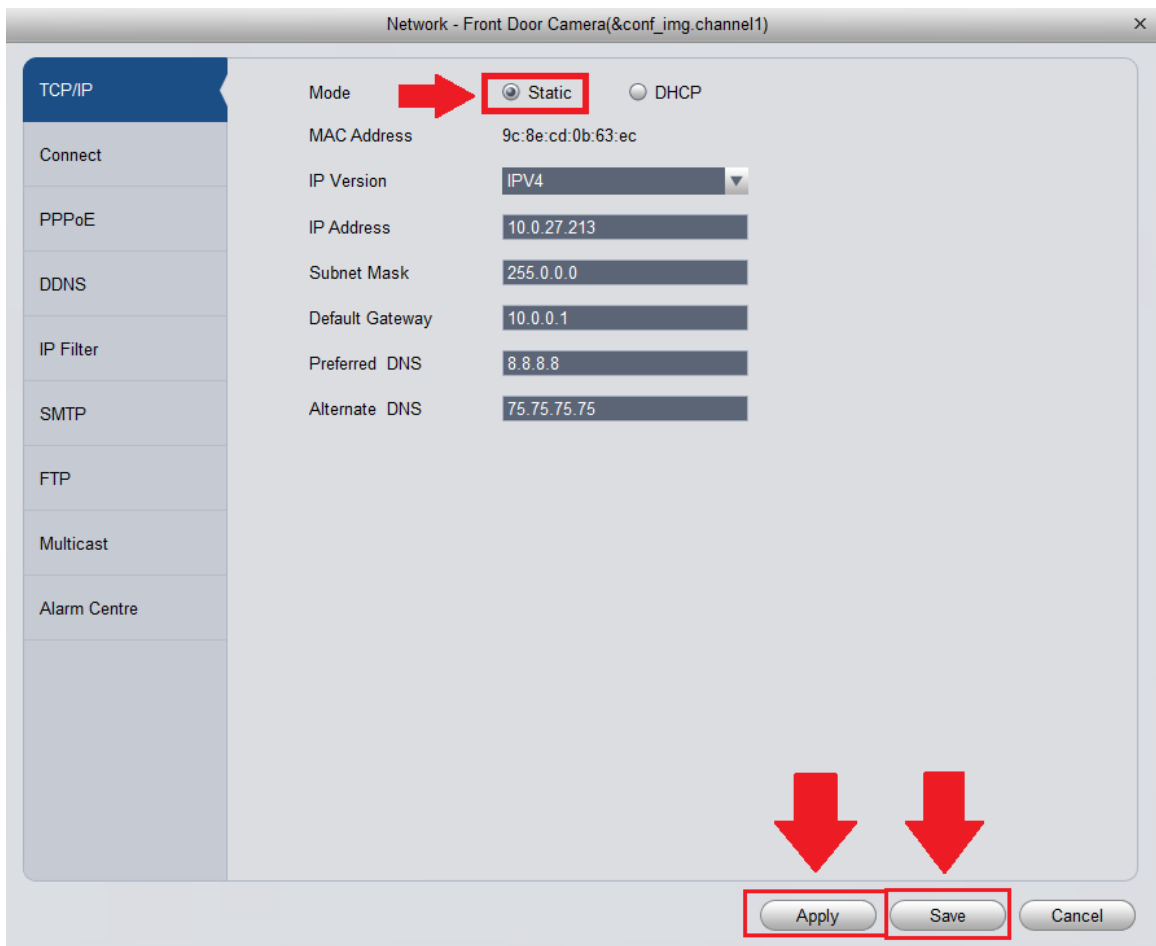

Viewing an Added Device



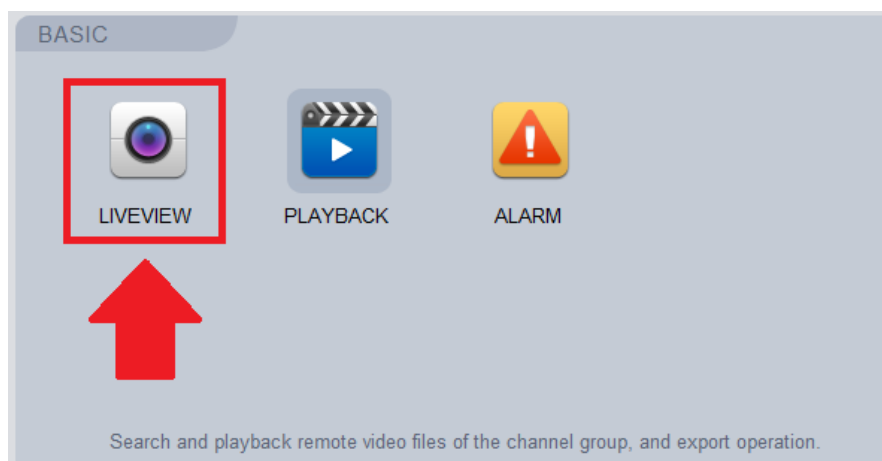



To begin viewing an added device, navigate to the **Home Page** of the software and click on the **LIVEVIEW** icon located in the **Basic** section.









In the **Organizations** menu, on the far-right side of the live view screen, double-click the device you want to view to load the live feed into the viewer.



For more details on the features listed in this menu, refer to the table provided below:

SN	Item	Function
1	Bit stream information and shortcut operation menu	<p>Please refer to the following contents for detailed information.</p> <ul style="list-style-type: none">  : Enable/disable local record.  : Snapshot.  : Enable/disable audio.  : Enable/disable bidirectional talk.  : Instant playback.  : Digital zoom  : Close current window.
2	Video window	Real-time video

3	Window split mode	 <ul style="list-style-type: none"> ● Sets the live view to 1- 64-window mode. ●  : Select a window and then click this button to customize its setup. ●  : Adjust video scale. ●  : Full screen.
4	Intelligent button	<ul style="list-style-type: none"> ●  : Save current liveview as image. You can view under View. ●  : Enable tour plan. ●  : Close tour plan.
5	PTZ	<p>It is for PTZ dome camera or fisheye camera series product only. Here you can set camera direction, zoom in, zoom out, iris, etc.</p> <p>Click the advanced button to set preset, tour, aux function or other settings related to PTZ.</p>
6	Device list	<p>Display device group and the corresponding channel.</p> <p>Here you can create a new group and drag a device to it.</p> <p>Right click a channel, you can select main stream/sub stream or quickly go to the device setup interface.</p>

How to Setup PC-NVR

PC-NVR allows your device to record directly to your computer’s hard drive. To setup PC-NVR on your computer, follow the instructions set provided below.

Note: PC-NVR is not compatible with MacOS. **PC-NVR is only compatible with Windows based operating systems.**

To begin setting up PC-NVR, navigate to the command prompt menu for your computer. The command prompt can be found by typing “cmd” in the **Type here to search** (Cortona) option on your desktop. Click on **Command Prompt**.

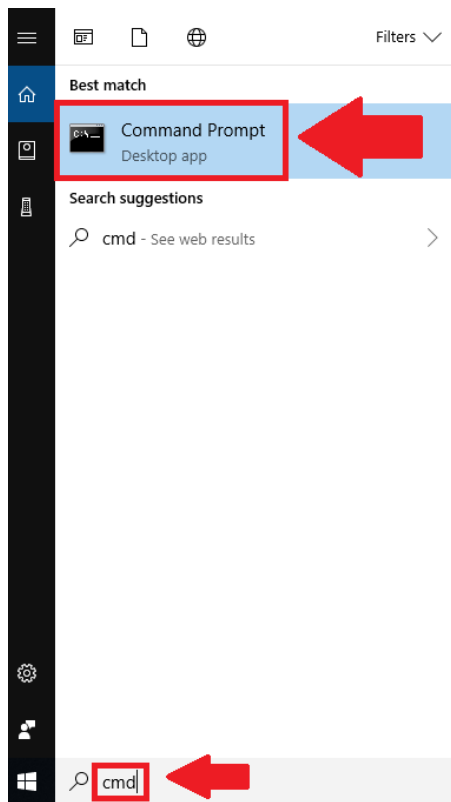

In the command prompt menu, type in **ipconfig** to access the **IPv4 Address** for your computer.

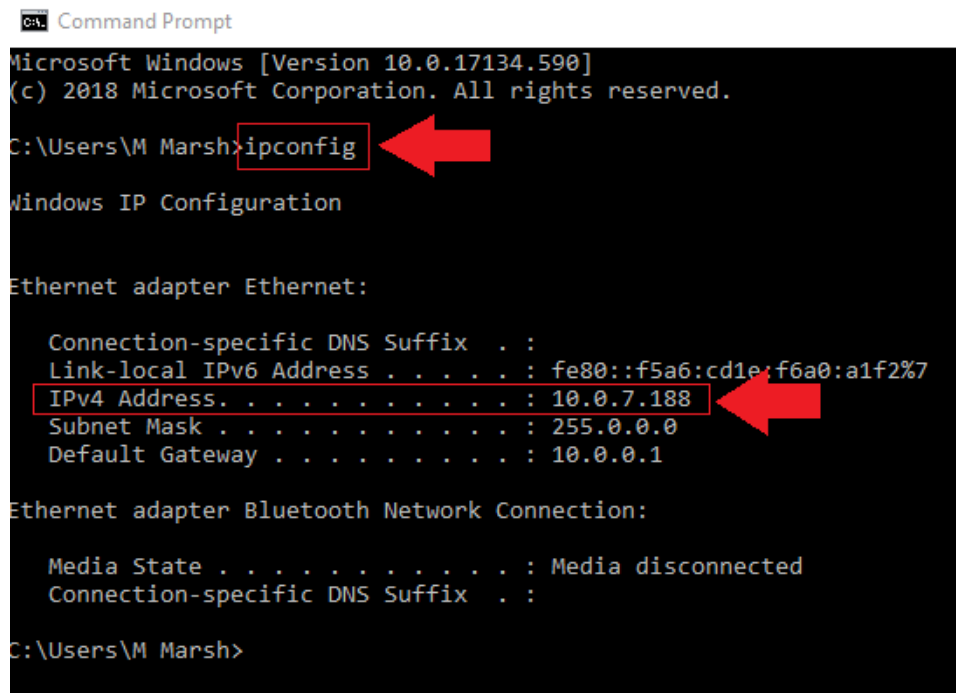

When the IPv4 address for your computer has been located, navigate back to the home page in the Amcrest Surveillance Pro software and click on the **Devices** icon located in the **Settings** menu.



In the **Devices** menu, click on the **Add** button. In the **Manually Add** screen enter a name, preferably “PC-NVR” and in the **IP/Domain Name** field, enter the **IPv4 Address** from the command prompt screen. Lastly, enter the username and password. The username and password will both be **admin**. When complete, press **Save and Continue** to proceed.

The 'Manually Add' dialog box contains the following fields and values:

- Device Name: PC-NVR
- Method to add: IP/Domain
- IP/Domain Name: 10.0.7.188
- Port: 37777
- Group Name: Default Group
- User Name: admin
- Password: [masked]

Buttons at the bottom: Save and Continue, Add, Cancel

The PC-NVR entry will then be added into the **Devices** menu.

To enable PC-NVR, navigate to the **Home Page** and in the **Settings** menu, click on the **PC-NVR** icon.

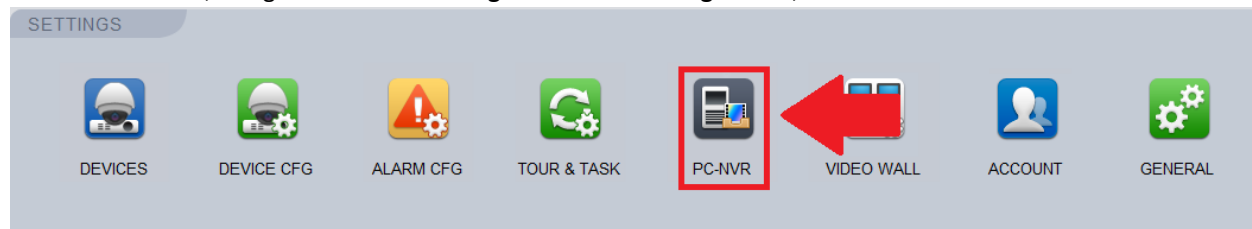

Once the **PC-NVR** tab opens, you will find your PC-NVR details, select **Remote Device**.

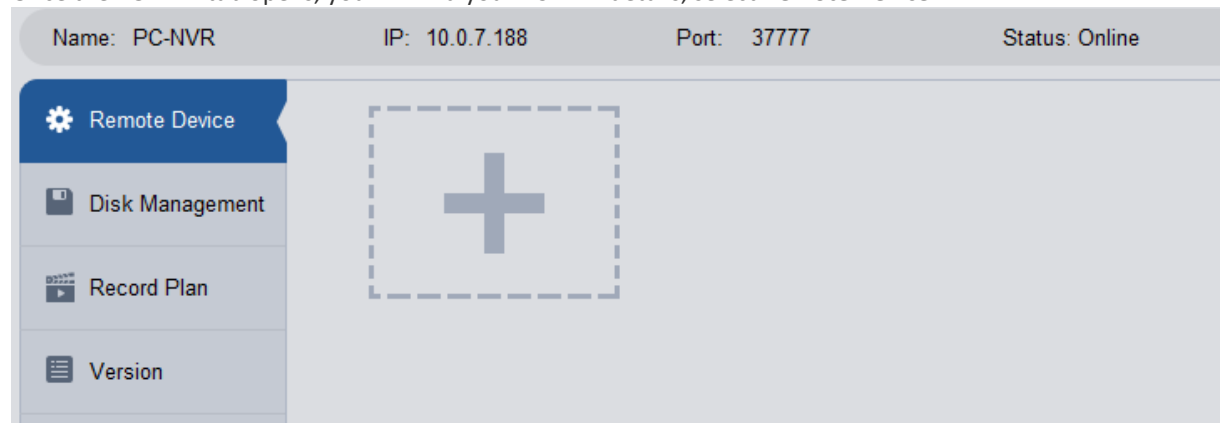

Click on the **Plus** button to add a camera from the cameras you have connected to Amcrest Surveillance Pro.



The **Add Channel** window will appear, select your camera from the **Default Group** or Custom Group list you've created.

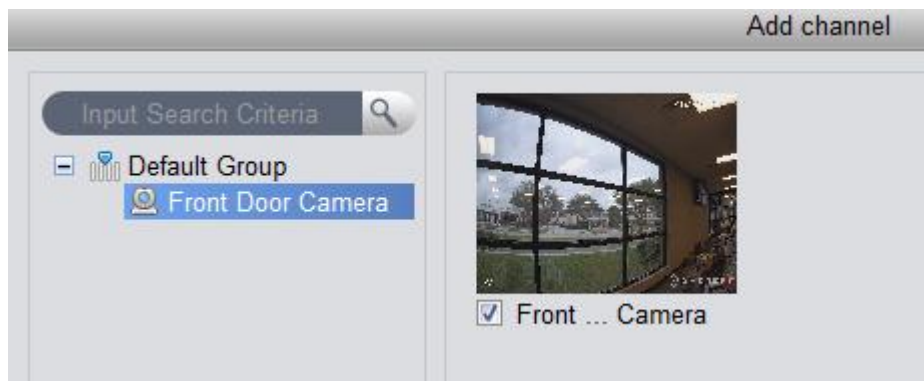

The camera will appear in the right screen, check the **IPCamera** check box. Click **Save**.

How to Setup Storage for PC-NVR Recording

Access the PC-NVR menu and navigate to the **Disk Manager** tab in the far-left corner of the screen.

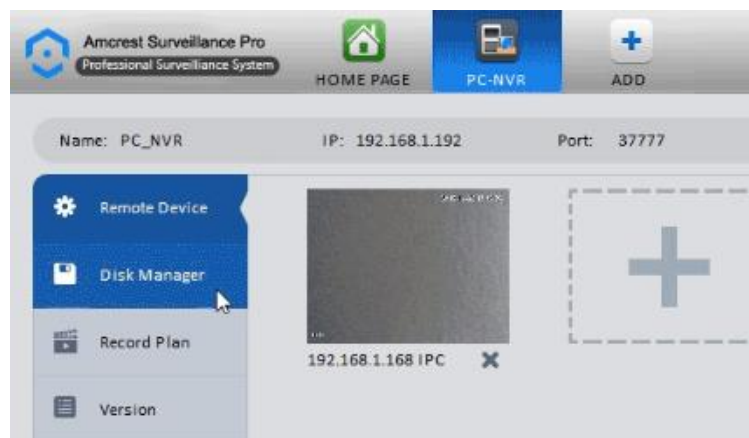

Disk Manager will appear showing you a list of drives that could be used to allocate storage space for your cameras through Amcrest Surveillance Pro.

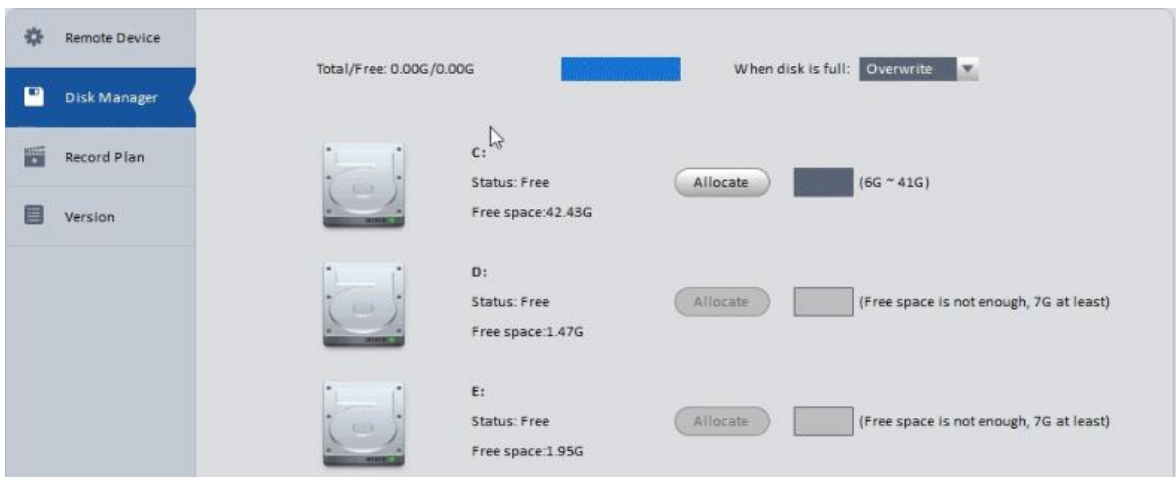

Select a disk you would wish to use for recording purposes, you may allocate as much space as you have available on the drive within its minimum and maximum allowance.

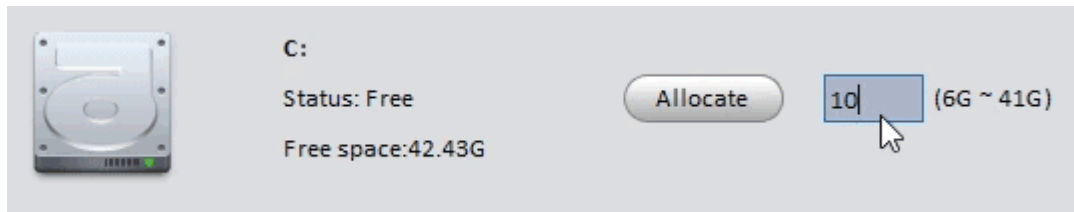

Once you've set a number between the possible storage sizes, click **Allocate**.

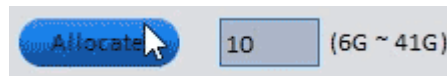

A prompt window will appear to warn you the allocation may take several minutes, and the application will restart after completion. Click **OK** to begin the allocation.

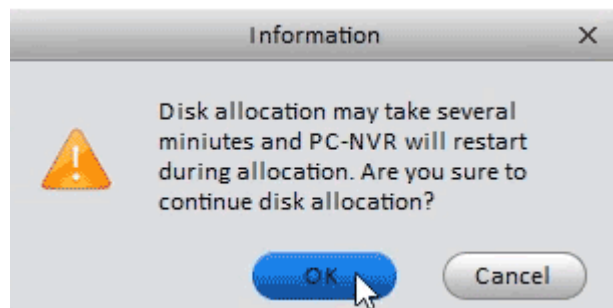

You will notice the disk you selected will now have the allocated space you selected, and at any point in time you can select **Free** to free up the space by wiping that allocation.

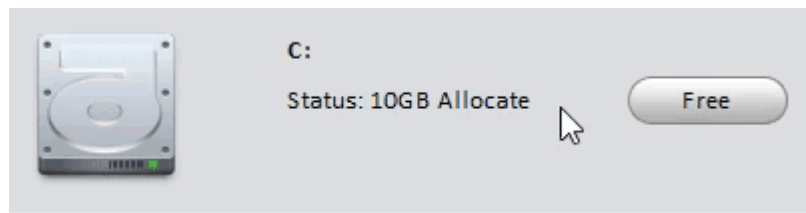

At the top of the **Disk Manager** window you can select what happens when the disk you've allocated gets full. Two options, **Stop Record** to end all recordings after the disk is full or **Overwrite** to continue to save over the oldest recorded data.



You've successfully added your camera to Amcrest Surveillance Pro, turned your computer into a PC-NVR and have the camera recording any or all the motion events you have set up internally on the cameras main interface.

How to Setup Recording

The Amcrest Surveillance Pro software allows you the opportunity to set your added device to record on motion or on continuous (general) recording. You can also set recording schedules for your device.

Storage

To begin setting up recording settings for your device, a microSD card or PC-NVR must be established to storage the recordings. When a storage device has been established in your device, navigate to the **Home Page** and click on the **Device CFG** icon in the settings menu. Select the device you wish to configure and in the **Storage** field, click on the **Record** icon.

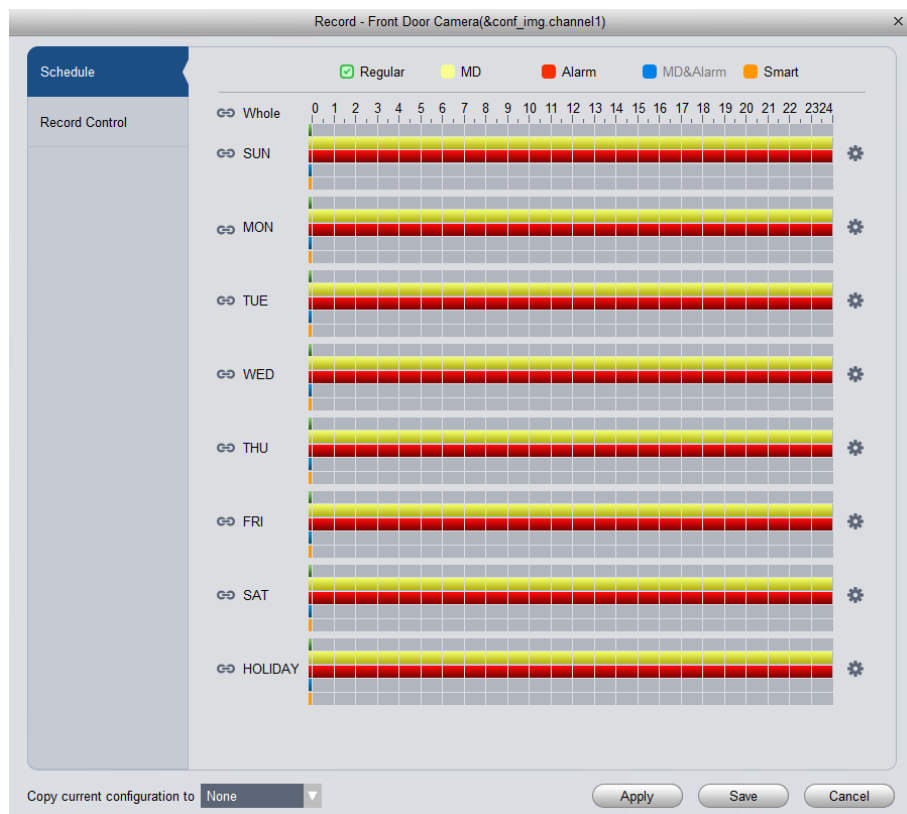

Below is a description of the fields listed in this menu:

Regular	Regular recordings are set to set your device for continuous recording. This field is designated by a green color in the software.
MD	MD, or Motion Detection recordings, are set to set your device to record on motion detection. This field is designated by a yellow color in the software
Alarm	Alarm recordings are set to set your device to record only when a specific alarm is triggered. This is designated by a red color in the software.
MD&Alarm	MD&Alarm, combine both motion detection and alarm settings into on specific attribute. This field is designated with blue color in the software.
Smart	Smart is set to only apply smart features such as, face detection or other intelligent features, to trigger recording. Amcrest cameras do not currently support smart features. However, this is designated with an orange color in the software.

To begin setting a record schedule for your device, click on the  icon next to the day you want to schedule your record plan.

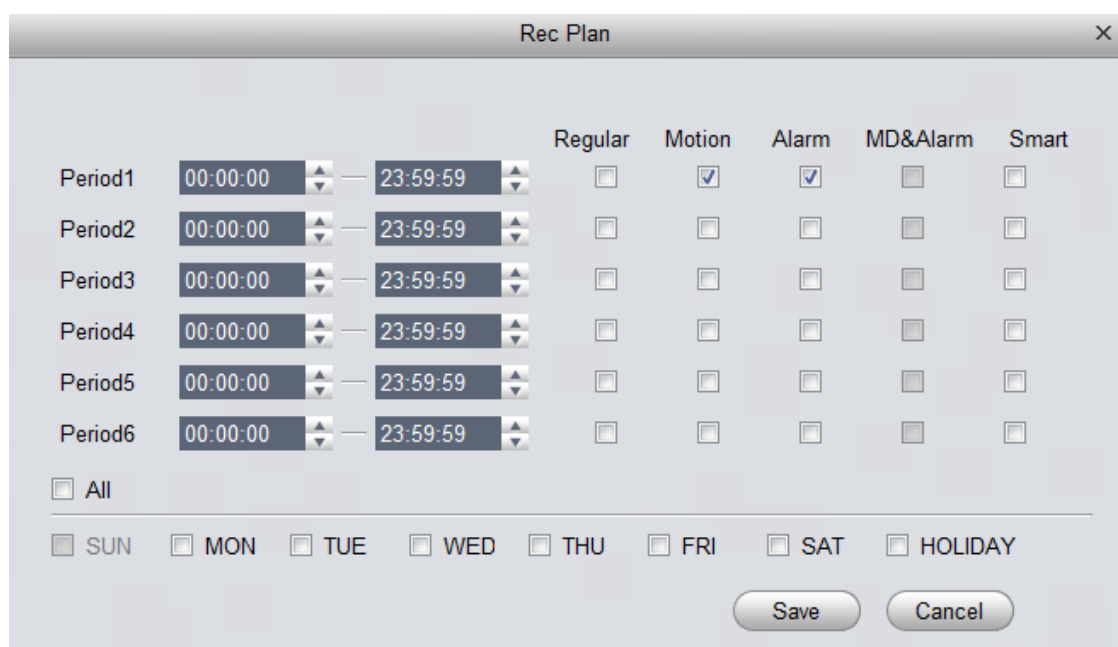

	Regular	Motion	Alarm	MD&Alarm	Smart
Period1	<input type="checkbox"/>	<input checked="" type="checkbox"/>	<input checked="" type="checkbox"/>	<input type="checkbox"/>	<input type="checkbox"/>
Period2	<input type="checkbox"/>	<input type="checkbox"/>	<input type="checkbox"/>	<input type="checkbox"/>	<input type="checkbox"/>
Period3	<input type="checkbox"/>	<input type="checkbox"/>	<input type="checkbox"/>	<input type="checkbox"/>	<input type="checkbox"/>
Period4	<input type="checkbox"/>	<input type="checkbox"/>	<input type="checkbox"/>	<input type="checkbox"/>	<input type="checkbox"/>
Period5	<input type="checkbox"/>	<input type="checkbox"/>	<input type="checkbox"/>	<input type="checkbox"/>	<input type="checkbox"/>
Period6	<input type="checkbox"/>	<input type="checkbox"/>	<input type="checkbox"/>	<input type="checkbox"/>	<input type="checkbox"/>

All

SUN MON TUE WED THU FRI SAT HOLIDAY

Save Cancel

Clicking this button opens a screen that allows for recording periods to be set for each day and for each recording type. There are a total of 6 periods that can be set. To set a recording schedule, select the record type (Regular, Motion, Alarm, MD&Alarm, Smart) and select the times you would like your schedule to apply. If you would like the record type to record 24/7 the period will remain on 00:00:00 – 23:59:59.

Next, select which days you would like the schedule to apply with and click **Save** to continue. If you would like the schedule to apply to all days, click the **All** button. On the main record menu, click on **Apply** and **Save** to save the schedule to the software.

How to View Playback

To playback recorded material in the Amcrest Surveillance Pro software, navigate back to the **Home Page** and in the **Basic** menu, click on **Playback**.

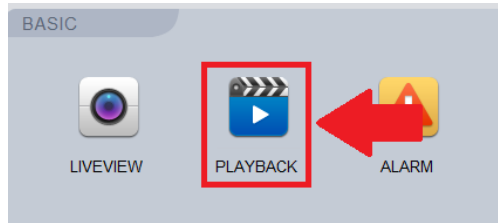

In the **Organizations** menu, click on the device you would like to view playback on. Ensure the checkbox next to the device name and group name are checked.

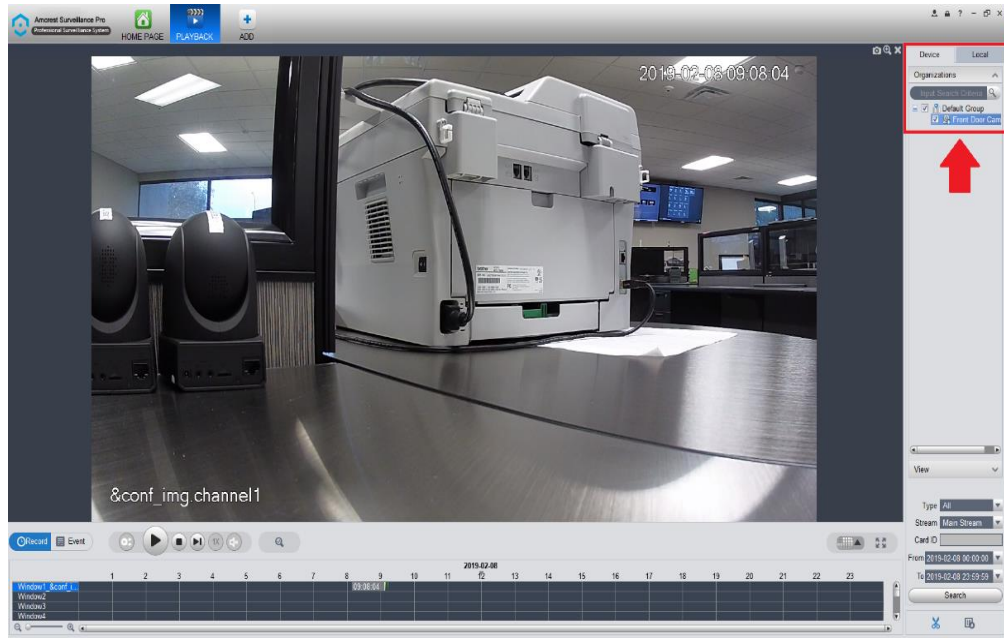

In the **Type** dropdown box, select which type of recording you would like to view. To view all records, make sure **All** is selected from the drop downbox. Next, ensure the correct stream is enabled in the **Stream** menu. The default stream will be **Main Stream**. Then, select a specified date and time for the file and click on **Search**.

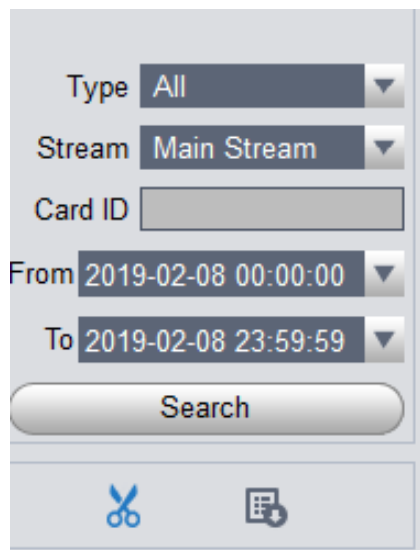

The play back controls can now be used to play, stop, skip to next event, control the speed of playback, and mute audio. If you're viewing more than one camera, on the right-hand side of the play back controls you will find a channel selection drop down menu to add or remove multiple channels, as well as go full screen.

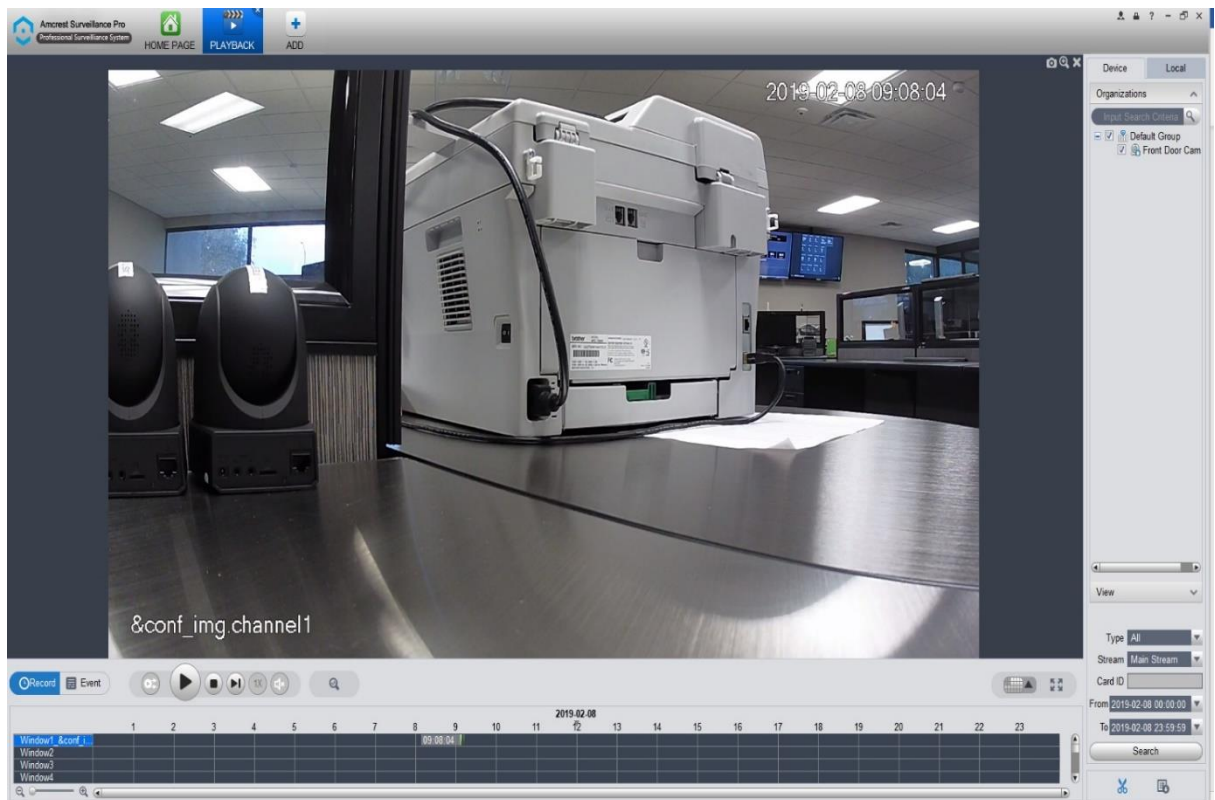

For more information on the Amcrest Surveillance Pro software and its functionality, please refer to the full Amcrest Surveillance Pro user manual which can be found at amcrest.com/aspusermanual

Access your camera and all its features and settings on your local network using Internet Explorer or Safari on Windows or Mac.

This method of accessing the camera's interface is necessary to setup remote access. Ensure that the following items are completed:

Note: Make sure the camera and the PC are on the same network before proceeding.

Use one of the following web browsers: Safari, Internet Explorer, or the Google Chrome app.

To easily connect to the camera's interface, install and run the Amcrest IP Config tool. You can download the IP Config software from www.amcrest.com under the "Support" tab, **Apps & Software**. The IP Config tool's interface looks like the below image:

4.4.2. Amcrest Blue Iris

Blue Iris is professional Windows based surveillance software that allows you to view and record up to 64 IP cameras, DVR/CCTV based cameras (\$59.95 Paid License for 64 Cameras) simultaneously. It is a third-party based, software that is compatible with a vast majority of IP camera and DVR brands.

In addition, it takes advantage of H.264 video compression allowing you to save hard drive space and reduce bandwidth consumption. Use Amcrest Blue Iris to turn your existing Windows PC into a fully featured professional video surveillance system.

For more details about Blue Iris software and its features, please visit <http://blueirissoftware.com/>

Installation

Blue Iris is a Windows based software, it is not available for Mac or Linux. For this reason, it is recommended for these users to use Amcrest Surveillance Pro as previously outlined.

To install the Amcrest Blue Iris software on your computer, please visit <https://amcrest.com/blue-iris.html> and download the Amcrest Blue Iris (for Windows Only) software to your computer.

Minimum requirements:

- Pentium dual-core or equivalent 2GHz processor or better
- 2GB or more system RAM
- Microsoft Windows XP SP3 or newer, or a server OS
- One or more USB or Network IP cameras, or an analog capture card with DirectShow drivers.

Recommendations when using many and/or HD cameras:

- Intel core i7 with QuickSync for hardware decoding
- 8GB or more RAM
- Microsoft Windows 8.1 or 10, 64 bit
- nVIDIA graphics adaptor for efficient screen display
- 7200+ RPM drives and/or SSD drive

To install the software on your computer, click on the **Amcrest+Blue+Iris.exe** file to launch the installation wizard. Click **Next** to begin the installation process and allow the software to download.

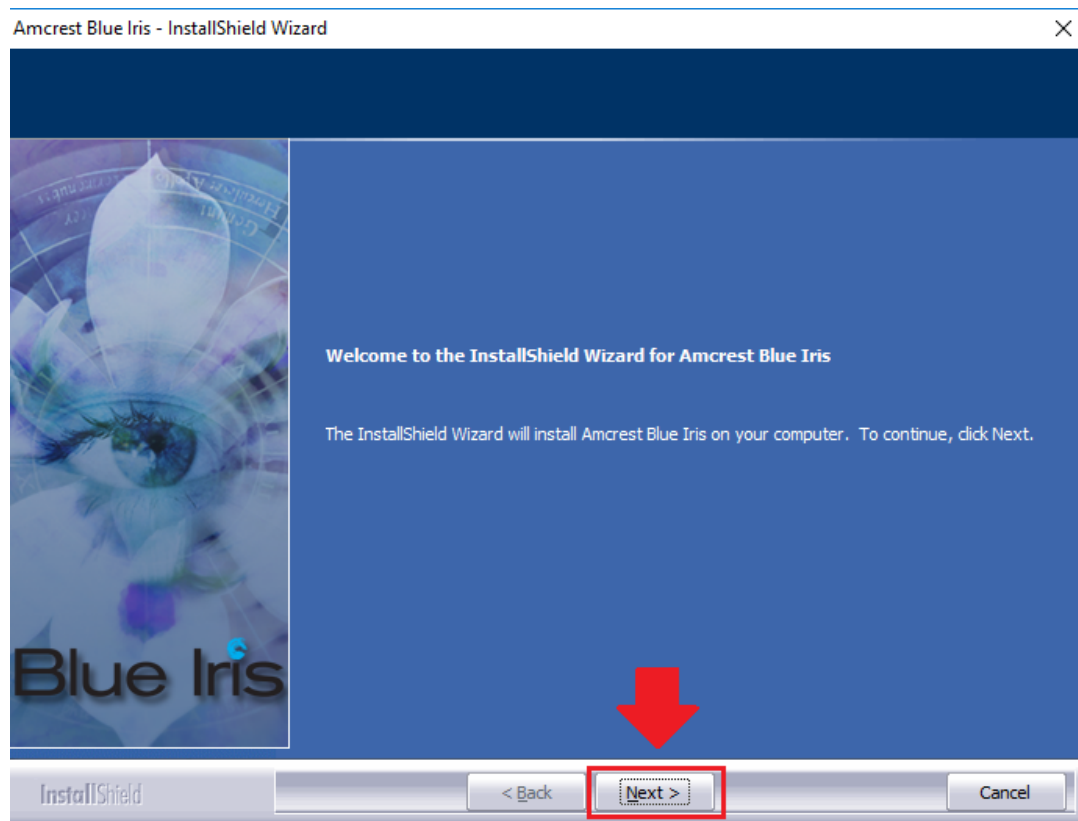

Please review the license terms before installing the Amcrest Blue Iris software. Read the license agreement carefully, and then to accept the terms, click the radio button next to the **I accept the terms in the license agreement** statement. Click **Next** to continue.

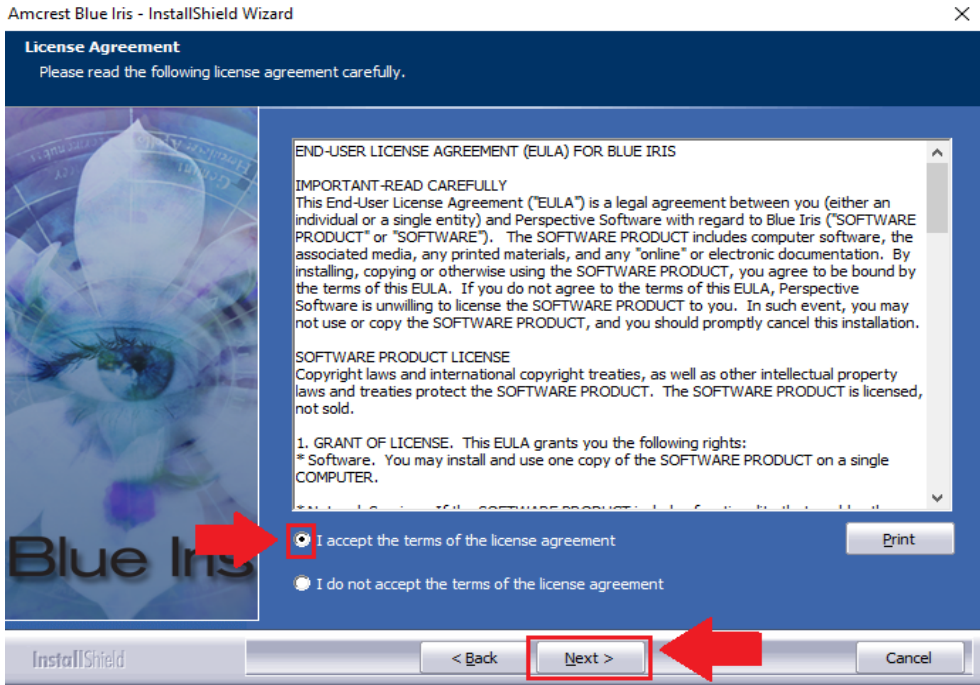

Choose a file destination in which you would like the Amcrest Blue Iris software to download. If you would like to specify another path, besides the default path, click **Change**. It is recommended to leave the default download path when installing the software. To continue the installation, click **Next**.

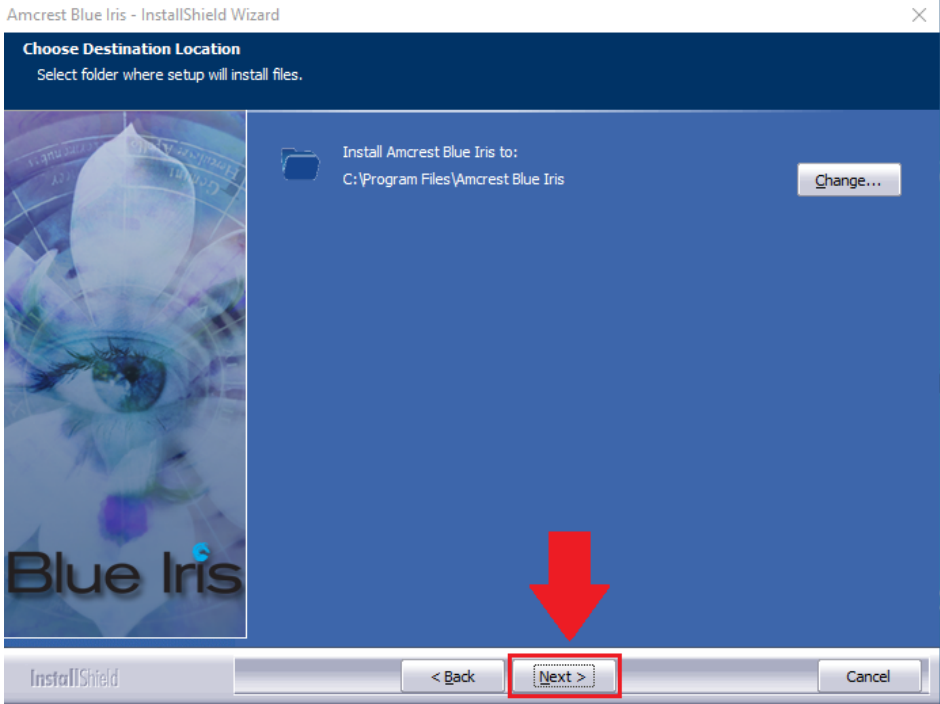

Select the features you want to install and deselect the features you do not want to install. If your OS is 64-bit it is highly recommended to leave this option at 64-bit. To continue, click **Next**.

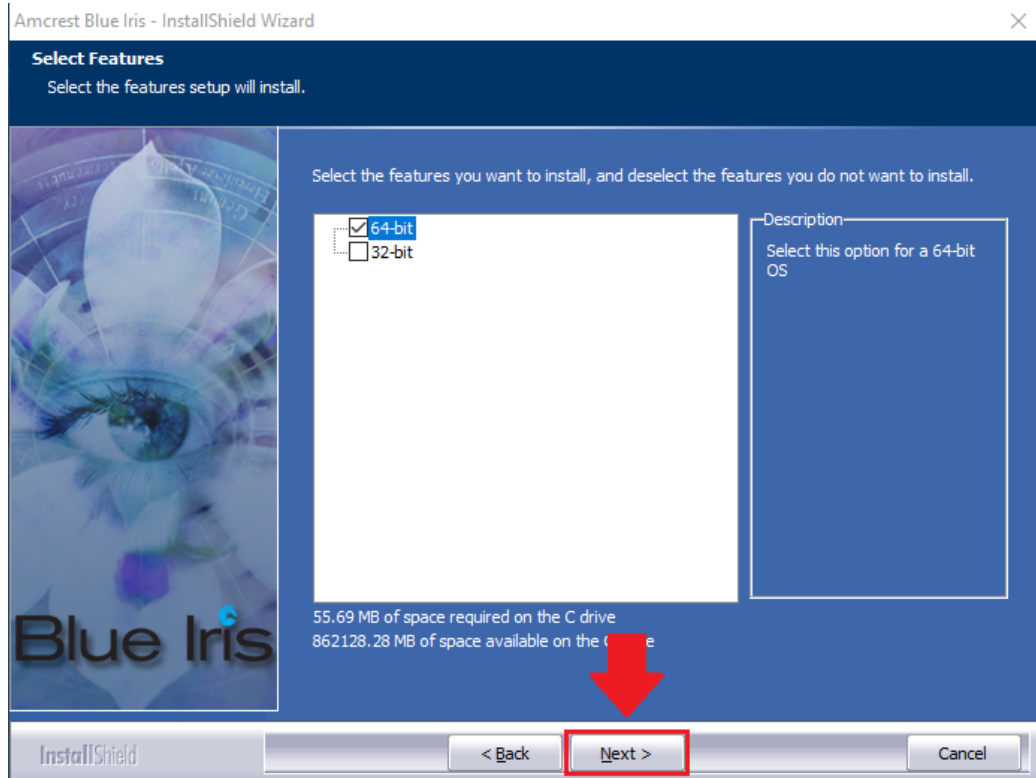

To begin installing the software click on the **Install** button and allow the software to download to your computer.



When the software has finished downloading, click on the **Finish** button to launch the software.

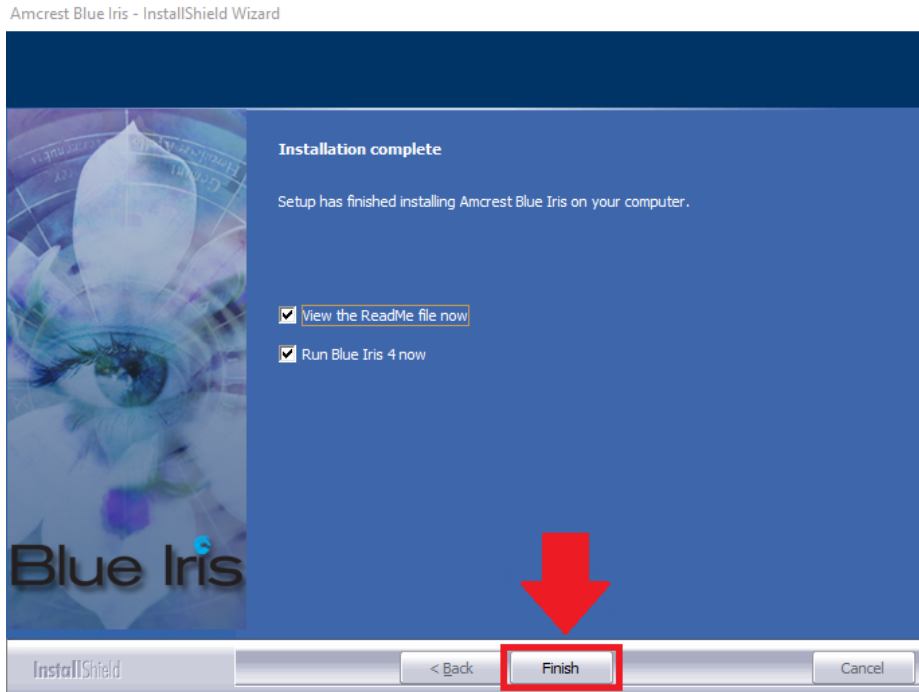

Note: if you do not wish to read the ReadMe file for the software, uncheck the **View the ReadMe file now** checkbox.

Purchasing an Amcrest Blue Iris License

Amcrest provides a 15-day free trial of the Amcrest Blue Iris software. If you find the Blue Iris software useful, please register and purchase a license. To continue the free trial version of this software, click **Next** to continue.

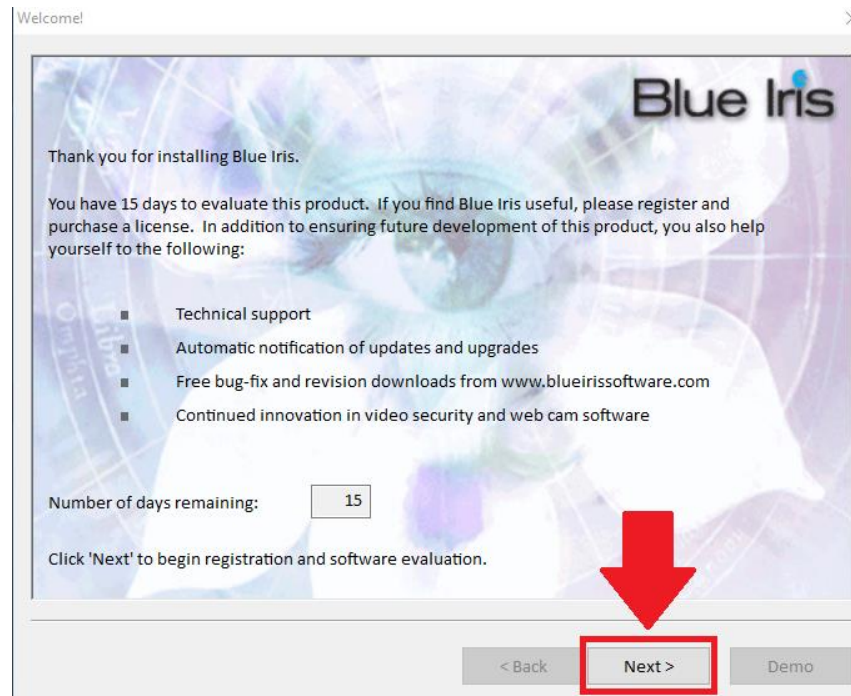

Amcrest offers two versions of the Blue Iris software; Full, and Lite. The full version (\$59.95) allows you to use up to 64 cameras with all the added features of Blue Iris. The Lite version allows you to use a single camera on the software with all the functionality of the software.

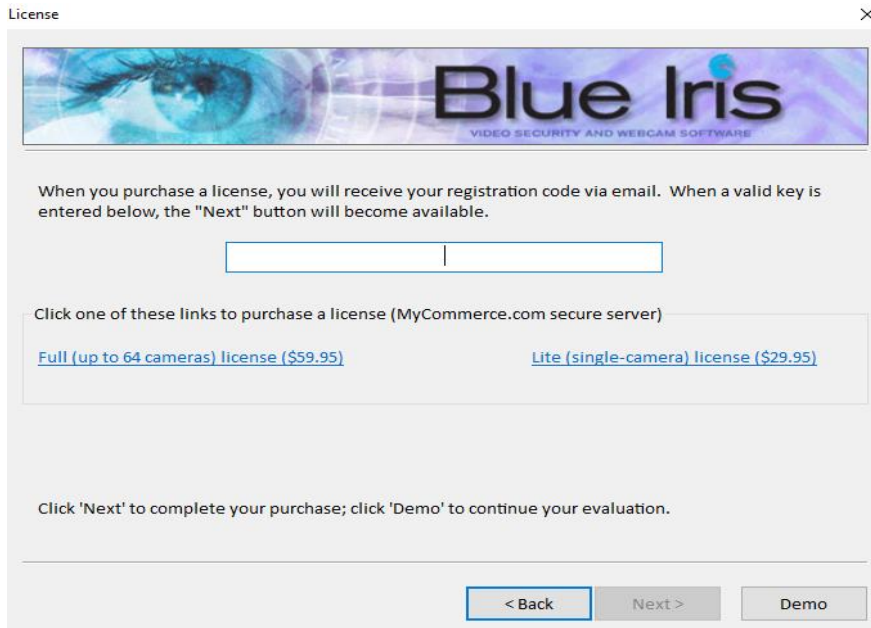

If you would like to purchase a license, select which license you would like to use and a registration code will be sent to your email address. When a valid key has been sent, enter the key into the **License** screen pictured above. If you would like to proceed with the free trial version, click on **Demo** to proceed to the evaluation version of the software.

Note: When accessing the software, make sure to **Allow access** to all communications blocked by Windows Defender.

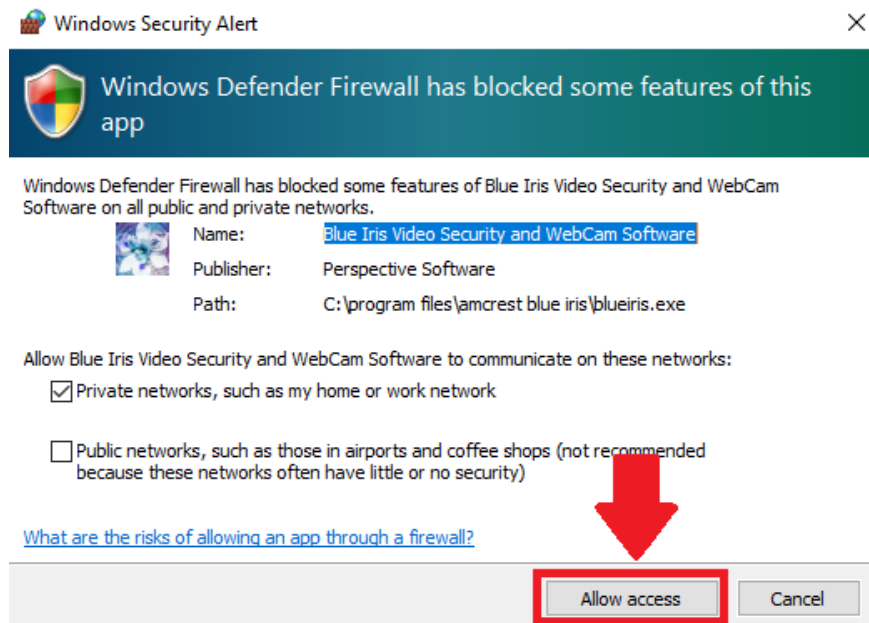

How To Add a Device Into Blue Iris

To add a device into the Blue Iris software, locate the IP address for your device using the Amcrest IP Config Tool. The Amcrest IP Config Tool can be downloaded at the following web page: amcrest.com/downloads. In the **All Downloads** menu, click on **IP Config Software** to begin the free download. Once the download has completed installing, locate the IP address associated with the device you would like to view in the browser.

No.	Type	Model	IP	TCP Port	HT
1	IPC	IP4M-1051	10.0.25.246	37777	80

This is the IP address that will be used in the Amcrest Blue Iris Software. To add a device, navigate to the Blue Iris software and click on the  button.

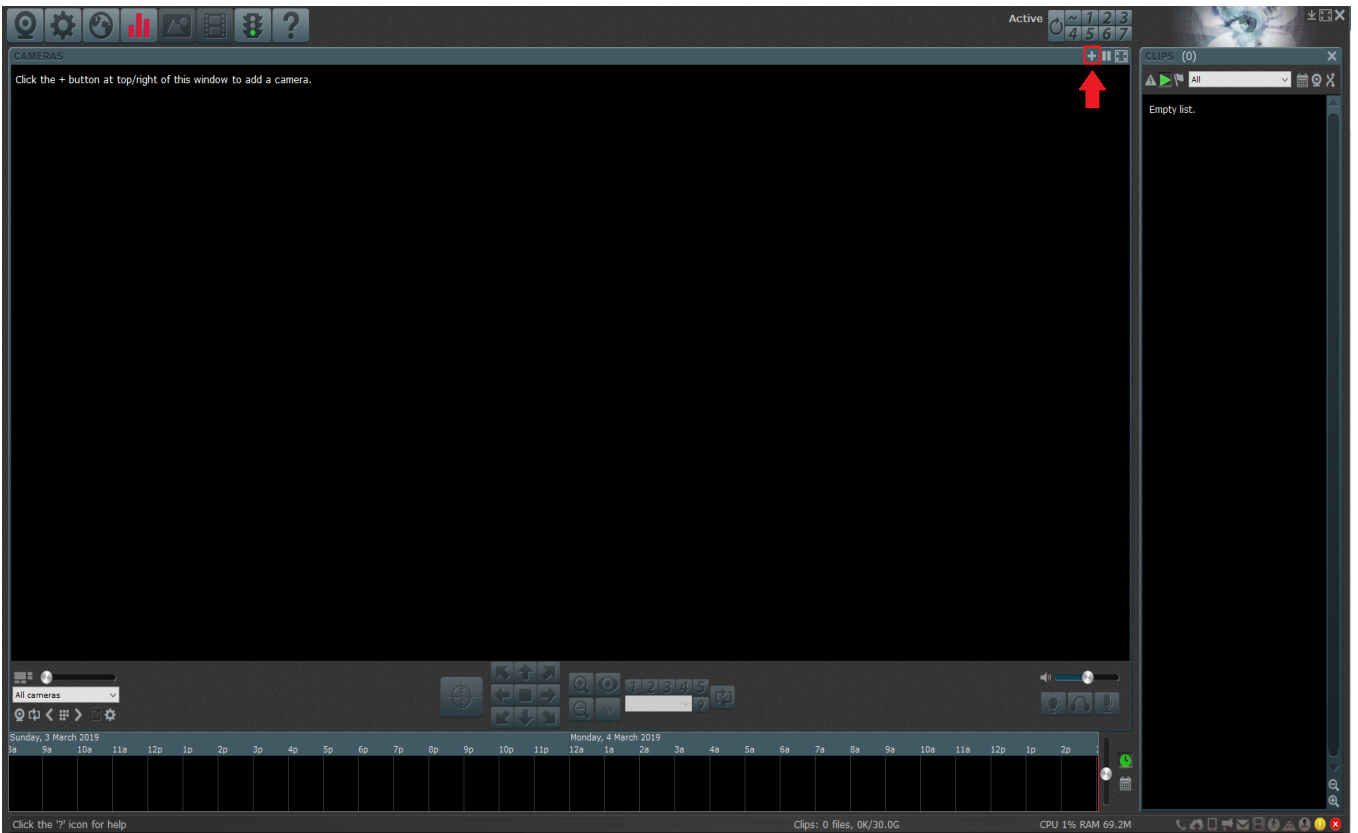

In the **New Camera** menu, provide a name for your camera. This can be a full name and a short name. Select which type of camera is being added to the software, and enable the options associated with your device. Click **OK** to continue.

New camera

Name

Full name

Short name (for URLs and filenames)

Names must be unique among all cameras and groups

Type

Network IP

USB, Analog, other

Import from exported .reg file

Copy from another camera

Options

Enable audio

Enable motion detector

Direct to disc recording (no re-encoding)

Next, enter the IP address of the device. This is the IP address discovered in the IP config tool. Enter the IP address in the **Address** field, then enter the user name and password for your device. If this is the first time using your camera, the password will be **admin**. Click OK to continue.

Network IP camera configuration

Address

http://

User Password

Make Media/video/RTSP port

Model Discovery/ONVIF port

Video

Path

Params

Camera

Network options

Receive buffer (MB)

Use RTP/UDP ports:

Send RTSP keep-alives

Use RTSP/stream timestamp

Skip initial HTTP DNS and reachability tests

Decoder compatibility mode

Get events with PullPointSubscription

Audio

Path

Format

Setup RTSP back-channel for talk support (PCM-U format)

The next screen will be the settings menu for your device. In this menu you can set Alerts, Schedules, PTZ/Control, General, Video, Audio, and other settings associated with your device. Click OK to continue.

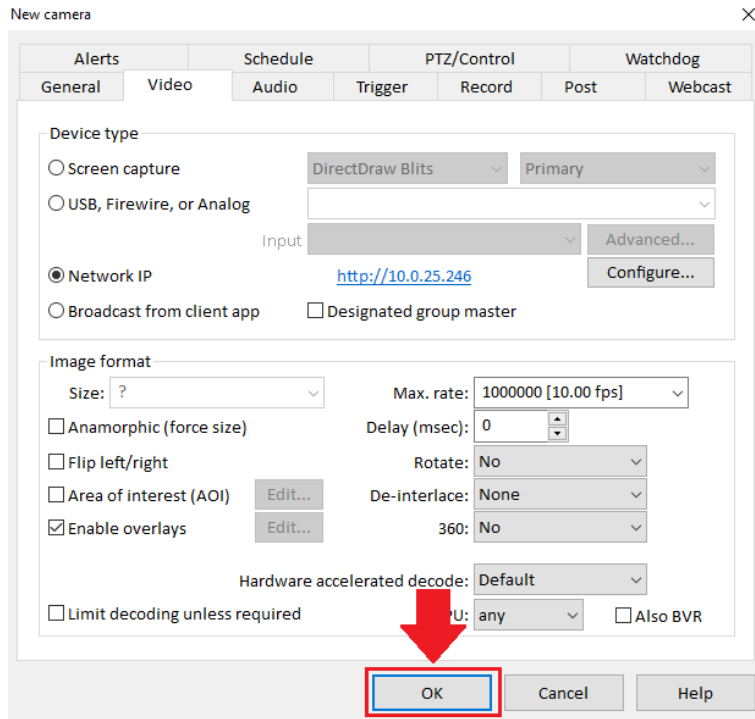

The device will now be successfully connected to the Blue Iris software.



To view an informative video on how to add an Amcrest device into the Amcrest Blue Iris software, please view this informative video: <https://www.youtube.com/watch?v=RqcfLHANCd8>

For more information on the features included in the Blue Iris software visit, <http://blueirissoftware.com/>

4.4.3. Web Operation

NPAPI plugins have been recently depreciated by most mainstream web browsers such as Google Chrome, Outlook, and Firefox. Currently, our team is pursuing a solution to this, however, as a primary means of accessing the web user interface for your Amcrest device in a web browser, **we recommend using Internet Explorer**. Other browser will also be functional such as, the Amcrest Web View app for Google Chrome, a previously released version of Mozilla Firefox, such as Firefox 49.0.2, or Safari 11.

As an alternative, other secondary browsers will also be functional for the web user interface such as, [SeaMonkey](#), and [Pale Moon](#) web browsers. SeaMonkey is compatible with Windows and Mac and is free to use, Pale Moon is only compatible with Windows and Linux systems. Conversely, both browsers will require the use of a plugin like other web browsers.

Note: Pale Moon users, please use the 32-bit version of the browser as the 64-bit version may be incompatible with our plugins.

You can also use the Amcrest Cloud to access your device from your computer. Amcrest Cloud does not require the use of a plugin to function and is compatible on most modern browsers. For more information on the Amcrest Cloud, visit amcrest.com/cloud.

Web Access for Safari and Mac Users

Most current versions of Safari do not support NPAPI plugins. Certain browsers, such as Safari 11, may be compatible, however, would require the user to revert from their current version of Safari to Safari 11. Amcrest has devised ways Mac users can enjoy their Amcrest products on their computers without the hassle of dealing with plugins with software such as Amcrest Blue Iris and Surveillance Pro.

Conversely, MacOS Mojave may be the last operating system to support 32-bit apps, such as, Amcrest Surveillance Pro. For this reason, it is highly advised for Mac users to take advantage of such options as the Google Chrome Extension app, Amcrest Blue Iris, Mozilla Firefox version 49.0.2., and SeaMonkey. Each of these methods of web-based access will be covered in the sections provided.

How to Install SeaMonkey

SeaMonkey is a free and open-source internet browser that serves as an excellent means of implementing the plugins required to access your device via a web browser. **SeaMonkey is compatible for both Windows and Mac Operating Systems**. It is a continuation of the former Mozilla Application Suite and is based on the same source code which itself grew out of Netscape Communicator and formed the base of Netscape 6 and Netscape 7.

To download SeaMonkey on your computer, visit <https://www.SeaMonkey-project.org/releases/> Select the download that applies to your computer and begin the installation process.

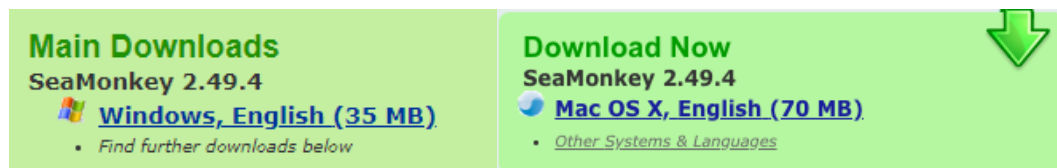

Click on the downloaded SeaMonkey Setup file and run the setup wizard. For purposes of these instructions we will be using Windows, however, the Mac setup process will be similar. Click **Next** to proceed.

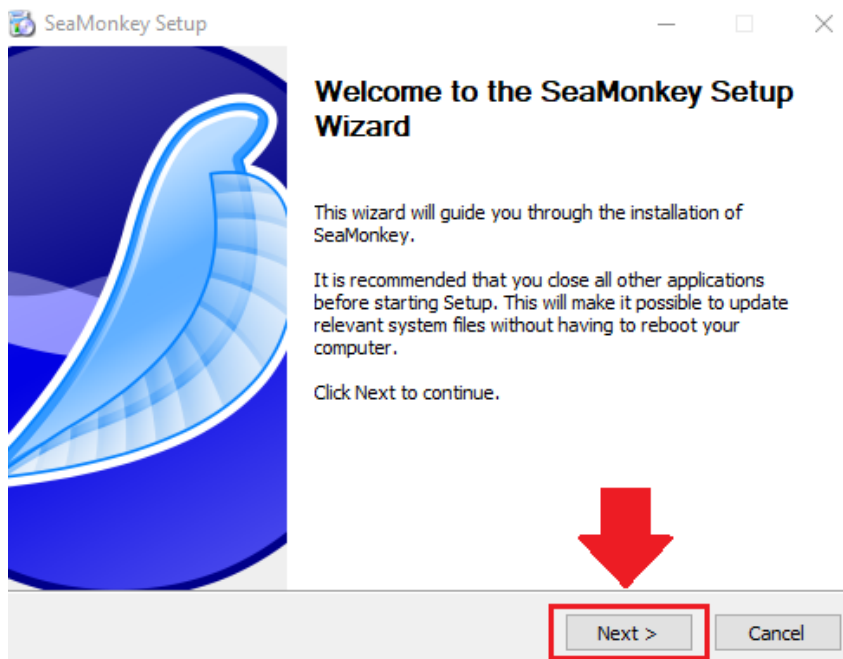

Please review the license terms before installing SeaMonkey. Read the license agreement carefully, and then to accept the terms, click the checkbox next to the **I accept the terms in the License Agreement** checkbox. Click **Next** to continue.

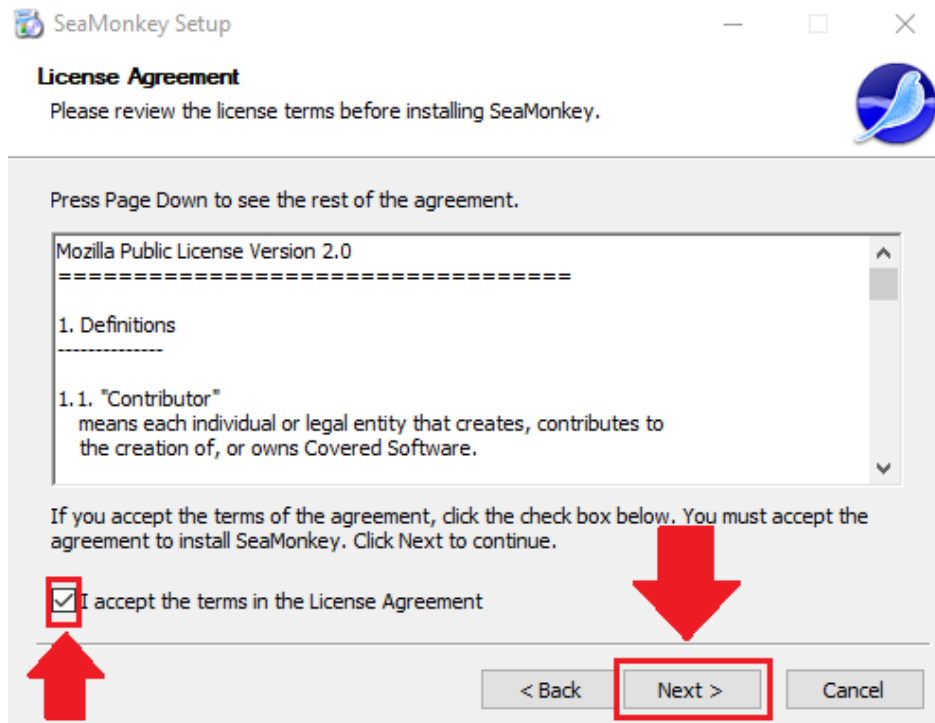

Choose the type of setup you prefer. There are two types of setup, **Standard** and **Custom**. In this case, it is recommended to run the standard setup since it is the most common. This is selected by default in the wizard. To continue, click the **Next** button.

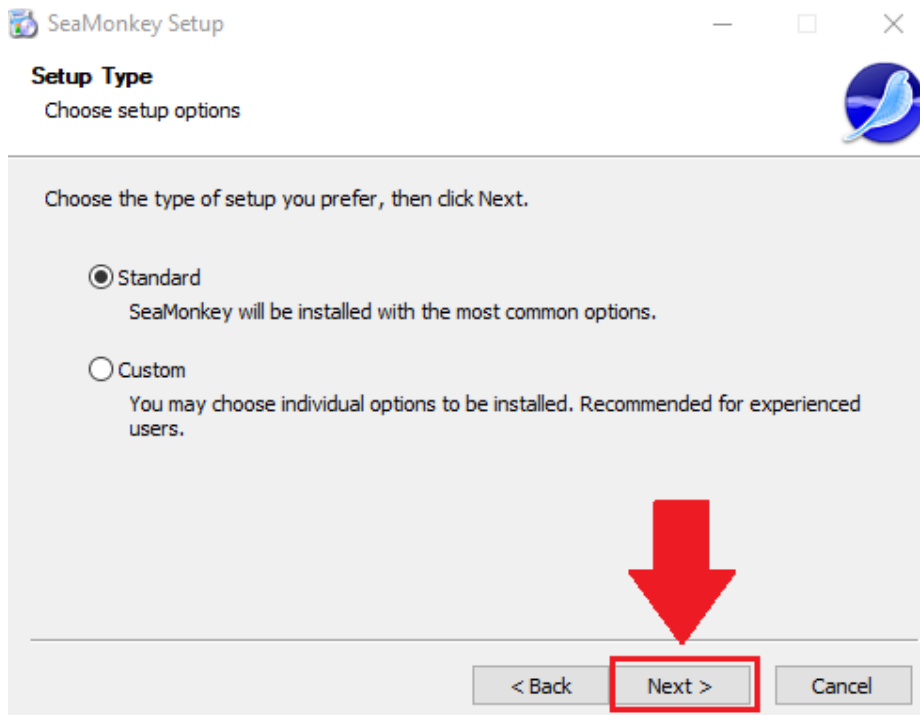

The wizard will then prompt you to install the software onto your computer. Click the **Install** button to install the browser.

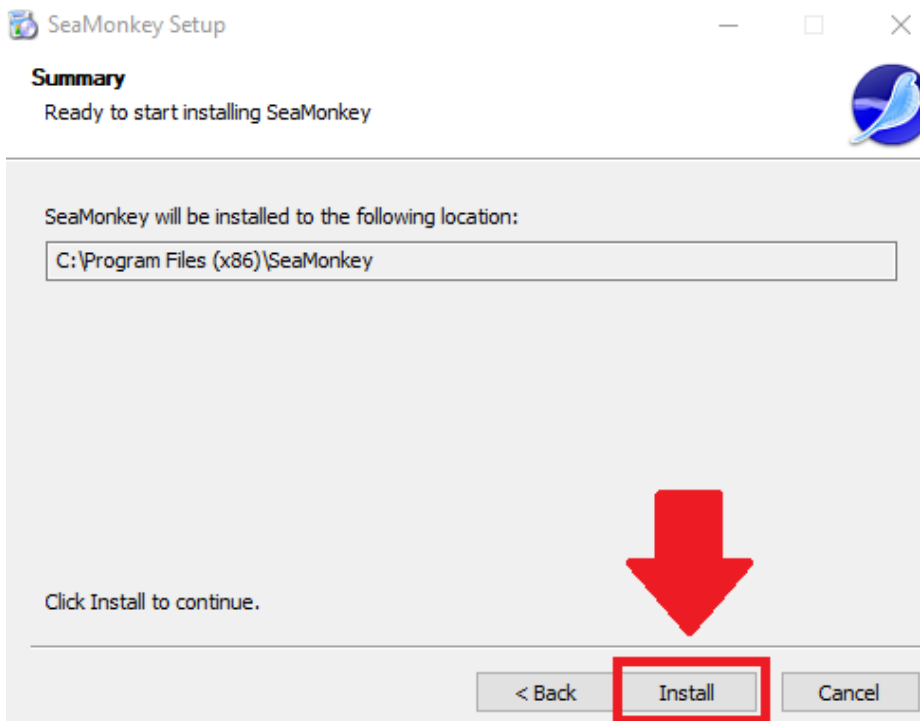

Allow the browser to install on your computer. When it has finished installing click on **Finish** to launch the browser.

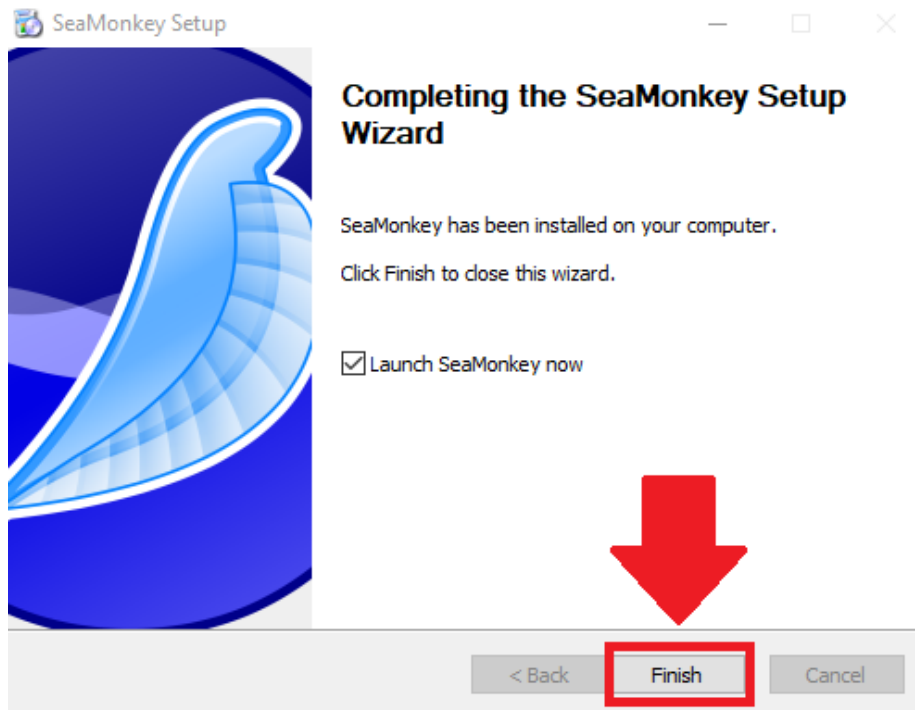

How To Access a Device Using SeaMonkey

To access the web user interface, locate the IP address for your device using the Amcrest IP Config Tool. The Amcrest IP Config Tool can be downloaded at the following web page: amcrest.com/downloads

In the **All Downloads** menu, click on **IP Config Software** to begin the free download. Once the download has completed installing, locate the IP address associated with the device you would like to view in the browser.

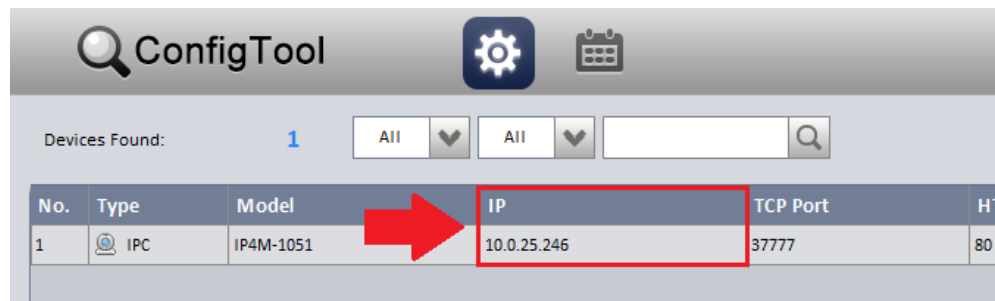

Enter this IP address into the SeaMonkey web browser to load the web user interface.

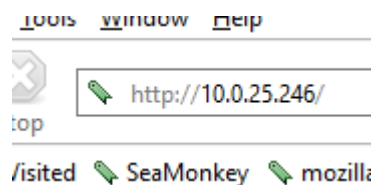

In the web user interface, enter the login credentials for your device. If this is the first time accessing the device, the username and password will both be **admin**. Click on **Login**.



If this is the first-time logging into your device, you will be prompted to modify the password for your device. To modify the password, enter the new password you would like to use in the **New Password** field and confirm. The password used should be between 8 and 32 characters long with a combination of letters and numbers. Click **Ok** when done to log into the web user interface.

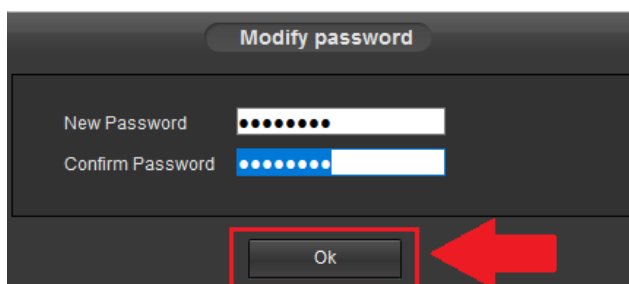

To view your device on the browser you will need to download the plugin. To download the plugin, click on the **Please click here to download and install the plugin** prompt in the middle of the screen.

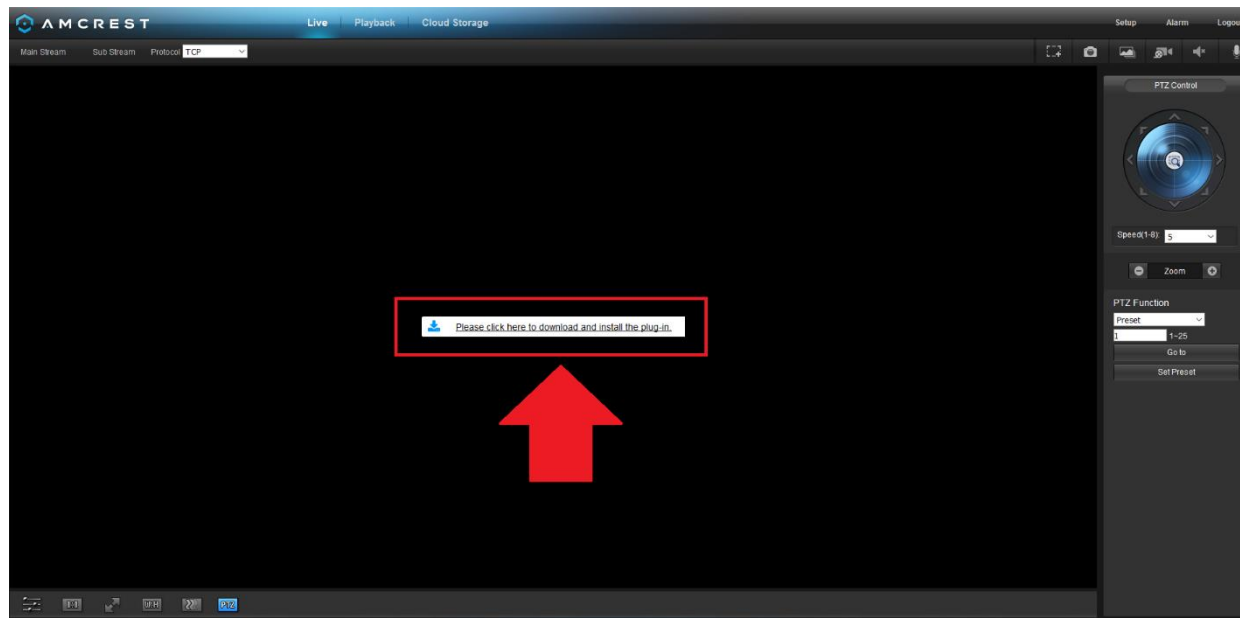

Click on **Save File** to begin downloading the plugin and save the file to your computer.

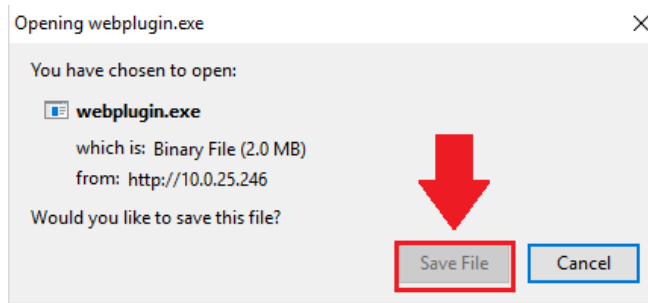

The browser's **Download Manager** will appear, showing the plugin file that was just downloaded. Double click on the file in the download manager to begin installing the plugin to the SeaMonkey web browser.

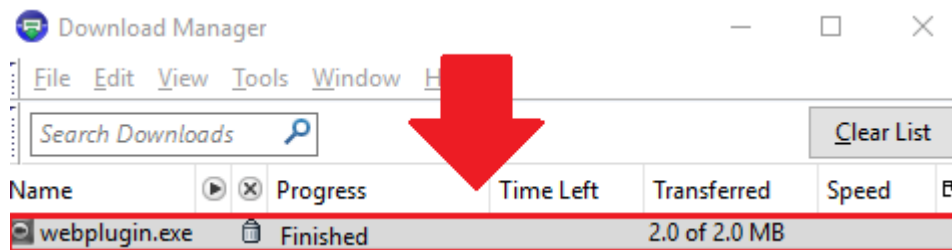

The browser will then show the live feed of your connected device in the web user interface.



For more information on the web user interface and the features it provides, please refer to the user manual for your device. User manuals can be found at amcrest.com/support or on the original listing of your device.

Using Multiple Cameras in the Web UI

Due to chipset limitations with certain model Amcrest cameras, different plugins may be required when accessing your camera on your computer.

This section is specifically geared towards customers who have 3MP and below cameras and are experiencing issues when accessing a newer, 4MP and above camera, simultaneously with their old setup. Higher megapixel cameras will require the use of a different plugin when accessing them on a web browser.

This is normal as most higher megapixel cameras require different internal hardware to function. Conversely, this may pose a compatibility issue when accessing a lower megapixel camera in a web browser at the same time as the higher megapixel camera since the higher megapixel camera's plugins will take precedence over the lower megapixel camera's plugin.

How To Install Pale Moon

Like SeaMonkey, Pale Moon is a free and open-source internet browser that serves as an excellent means of implementing the plugins required to access your device via a web browser. **Pale Moon is only compatible with Windows and Linux** operating systems however, a beta version is coming soon for Mac. The browser is a continuation of the former Mozilla Application Suite and is based on the same source code which itself grew out of Netscape Communicator and formed the base of Netscape 6 and Netscape 7.

To download Pale Moon on your computer, visit <https://www.palemoon.org/download.shtml> Select the download that applies to your computer from the **32-bit** downloads link section on the page and begin the installation process.

Click on the downloaded Pale Moon Setup file and run the setup wizard. For purposes of these instructions we will be using Windows, however, other setup process will be similar. Click **Run** to proceed to the setup wizard. Click **Next** to begin.

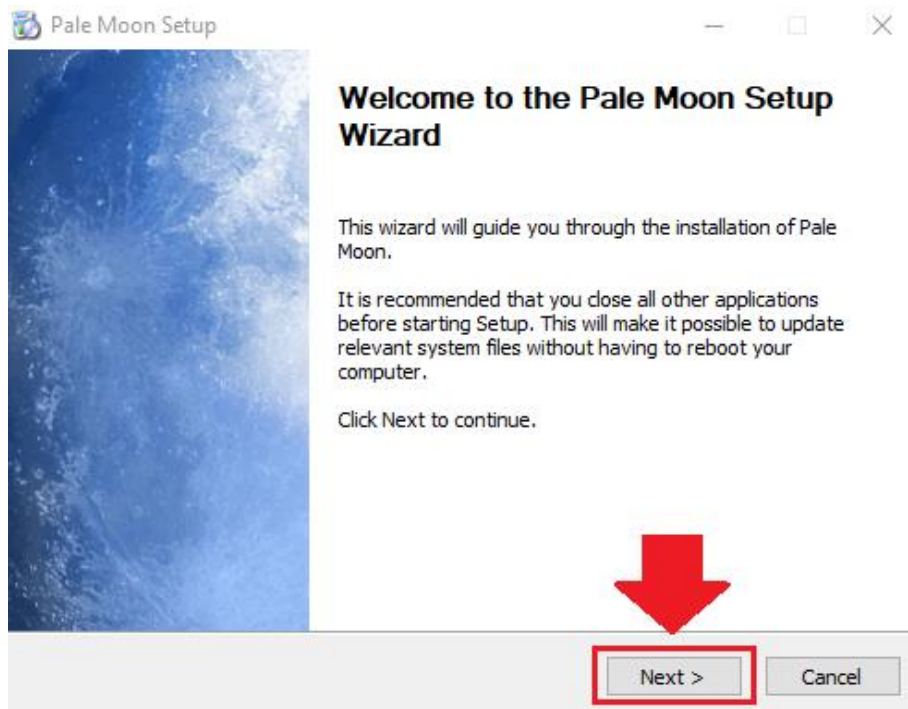

Choose the type of setup you prefer. There are two types of setup, **Standard** and **Custom**. In this case, it is recommended to run the standard setup since it is the most common. This is selected by default in the wizard. To continue, click the **Next** button.

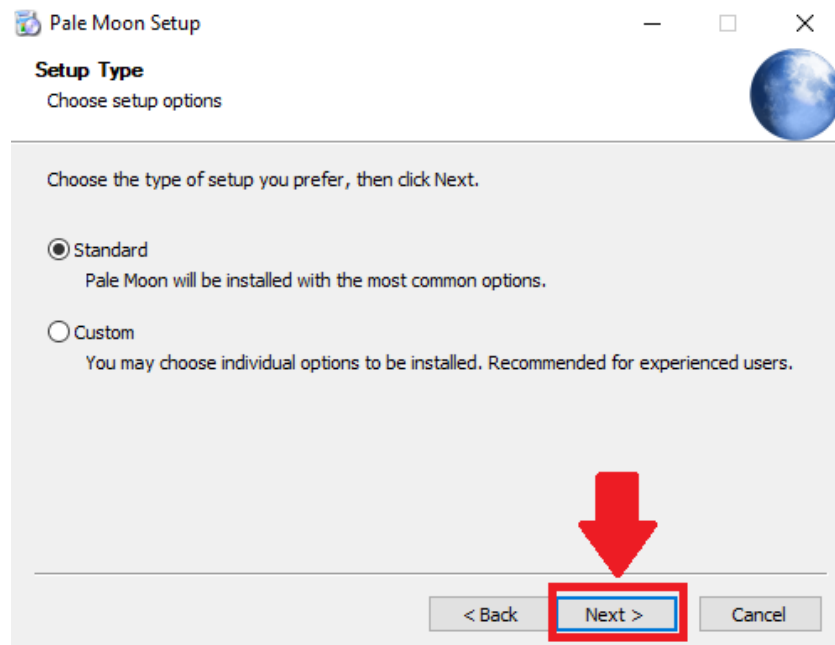

The wizard will then prompt you to install the software onto your computer. Click the **Install** button to install the browser.

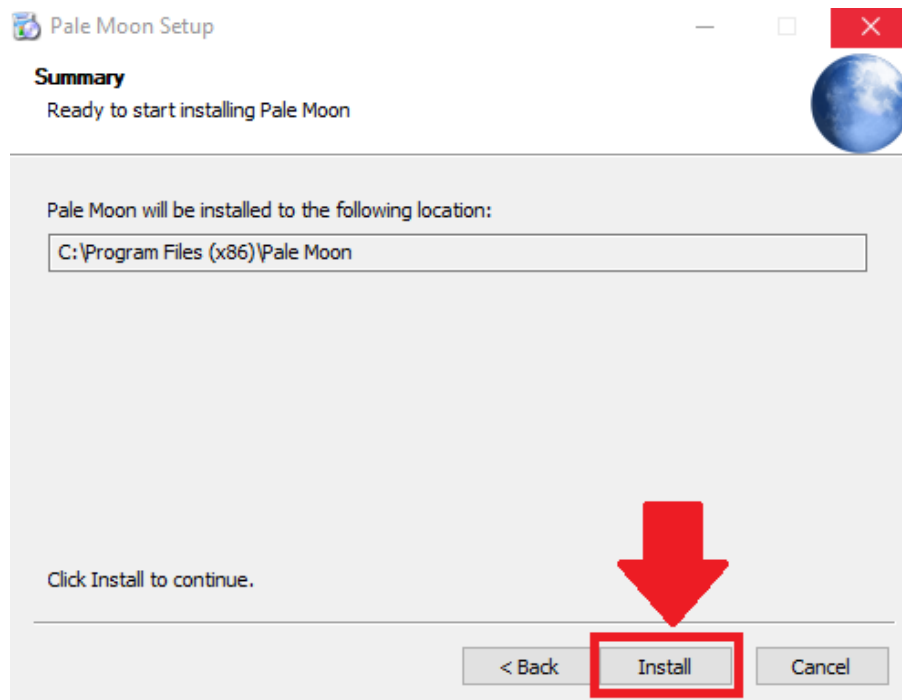

Allow the browser to install on your computer. When it has finished installing click on **Finish** to launch the browser.

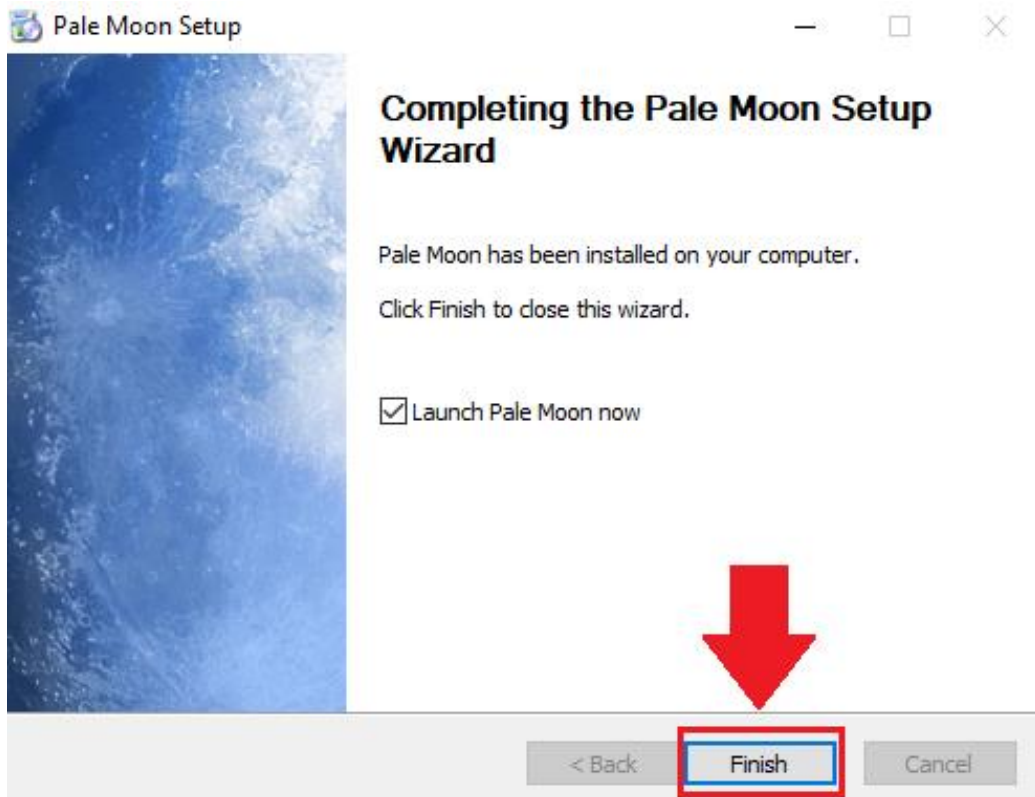

How To Access a Device Using Pale Moon

To access the web user interface, locate the IP address for your device using the Amcrest IP Config Tool. The Amcrest IP Config Tool can be downloaded at the following web page: amcrest.com/downloads

In the **All Downloads** menu, click on **IP Config Software** to begin the free download. Once the download has completed installing, locate the IP address associated with the device you would like to view in the browser.

No.	Type	Model	IP	TCP Port	HT
1	IPC	IP4M-1051	10.0.25.246	37777	80

Enter this IP address into the Pale Moon web browser to load the web user interface.

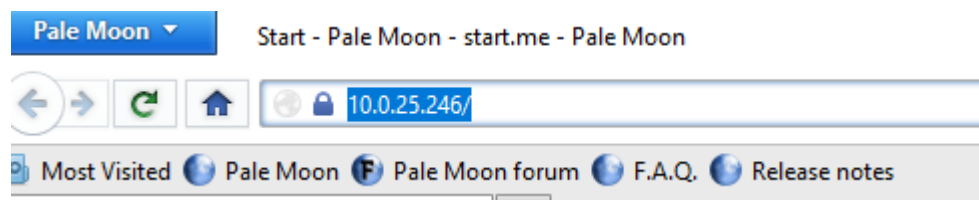

In the web user interface, enter the login credentials for your device. If this is the first time accessing the device, the username and password will both be **admin**. Click on **Login**.



If this is the first-time logging into your device, you will be prompted to modify the password for your device. To modify the password, enter the new password you would like to use in the **New Password** field and confirm. The password used should be between 8 and 32 characters long with a combination of letters and numbers. Click **Ok** when done to log into the web user interface.

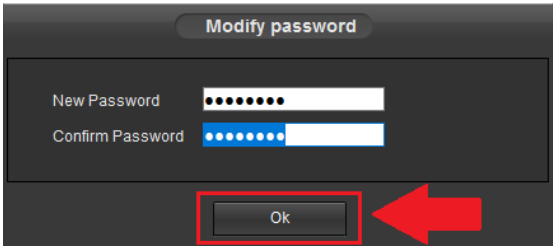

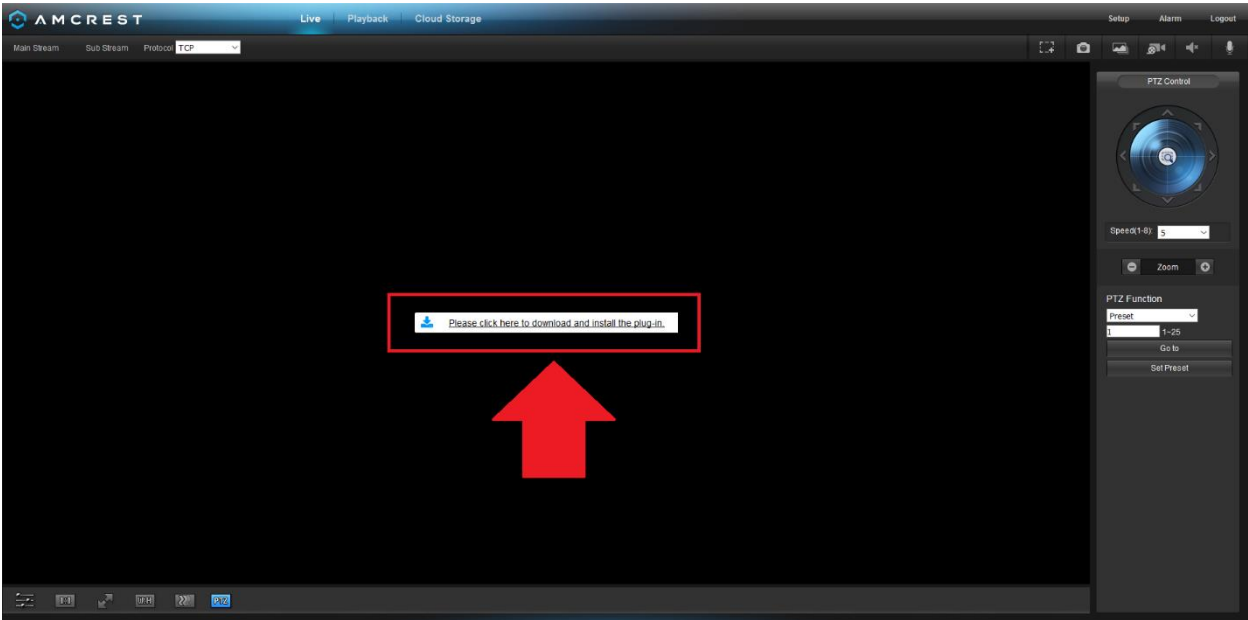

To view your device on the browser you will need to download the plugin. To download the plugin, click on the **Please click here to download and install the plugin** prompt in the middle of the screen.

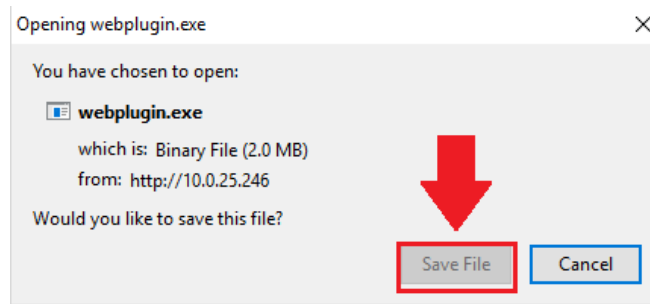

Click on **Save File** to being downloading the plugin and save the file to your computer.



The webplugin.exe will then be downloaded to the downloads folder and be shown in the **Download Manager**  in the upper right-hand corner of the browser. To launch the plugin, click on the  and click on the webplugin.exe file in the download manager.

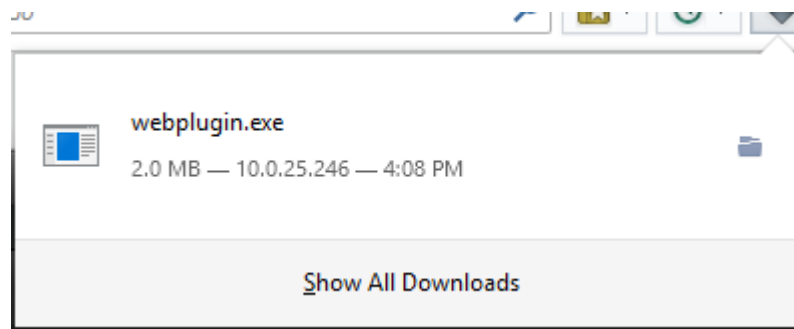

The browser will then show the live feed of your connected device in the web user interface.

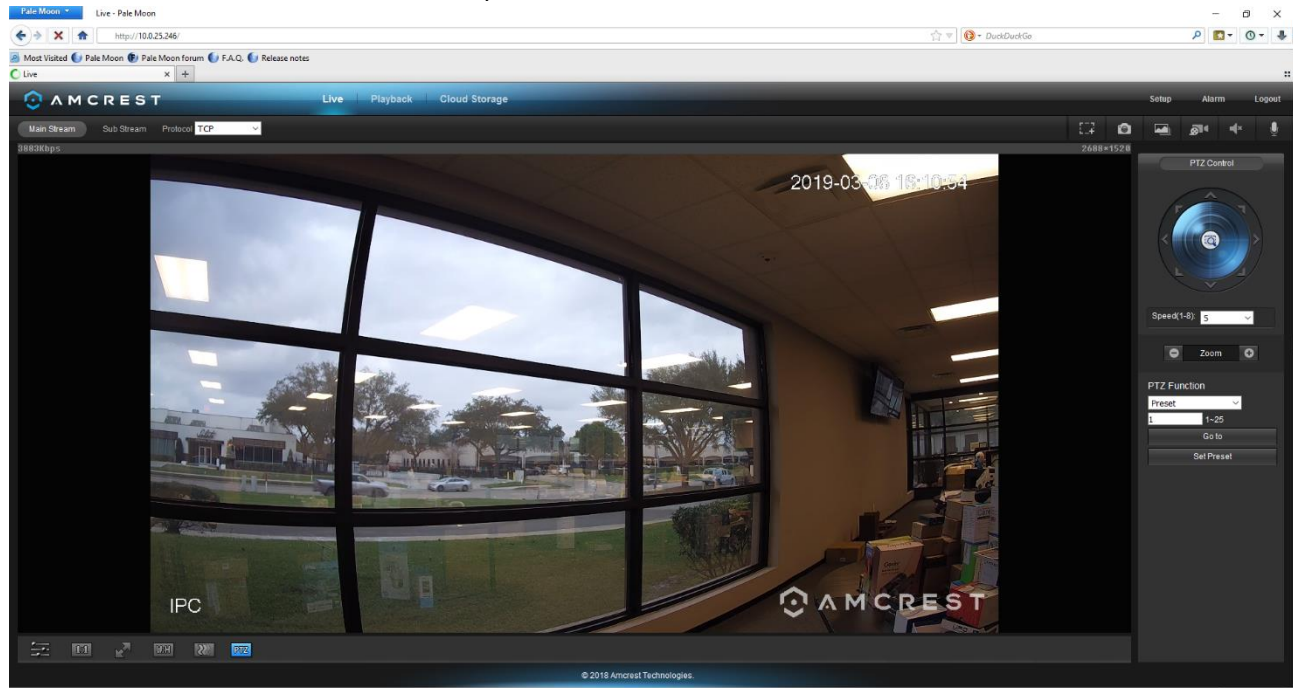

For more information on the web user interface and the features it provides, please refer to the user manual for your device. User manuals can be found at amcrest.com/support or on the original listing of your device.

Using Multiple Cameras in the Web UI

Due to chipset limitations with certain model Amcrest cameras, different plugins may be required when accessing your camera on your computer.

This section is specifically geared towards customers who have 3MP and below cameras and are experiencing issues when accessing a newer, 4MP and above camera, simultaneously with their old setup. Higher megapixel cameras will require the use of a different plugin when accessing them on a web browser.

This is normal as most higher megapixel cameras require different internal hardware to function. Conversely, this may pose a compatibility issue when accessing a lower megapixel camera in a web browser at the same time as the higher megapixel camera since the higher megapixel camera's plugins will take precedence over the lower megapixel camera's plugin.

How To Access a Device Using the Google Chrome Extension

Web based access for Amcrest device can be utilized in Google Chrome using the Amcrest Web View Chrome App. This is an app designed by Amcrest specifically for the use of accessing your device in Chrome without the use of a plugin and is available in the Chrome web store. To add the Amcrest Web View app to your browser, click [here](#).

Adding the Amcrest Web View App

In the Chrome Web Store, click on the **Add to Chrome** button to add the extension to your Chrome browser.

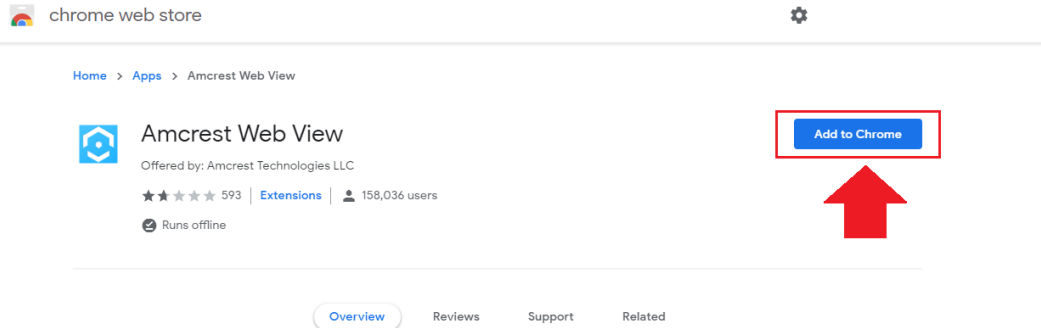

To confirm the addition of the Amcrest Web View app to your browser, click on the **Add app** option listed in the popup.

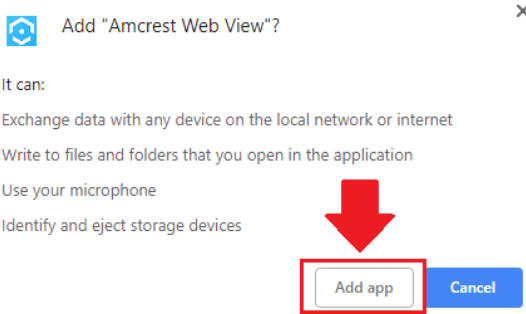

The app will begin to download to your Chrome app store. The Chrome app store can be accessed by typing the following URL into your browser: `chrome://apps` Click on the **Amcrest Web View** to launch the app.

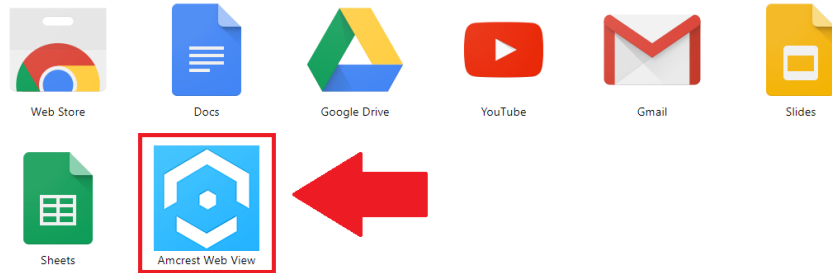

To access your device using the Google Chrome Extension please refer to the information provided below. Locate the IP address for your device using the Amcrest IP Config Tool. The Amcrest IP Config Tool can be downloaded at the following web page: amcrest.com/downloads

In the **All Downloads** menu, click on **IP Config Software** to begin the free download. Once the download has completed installing, locate the IP address associated with the device you would like to view in the browser.

No.	Type	Model	IP	TCP Port	HT
1	IPC	IP4M-1051	10.0.25.246	37777	80

Enter this IP address into the Chrome web browser to load the web user interface.

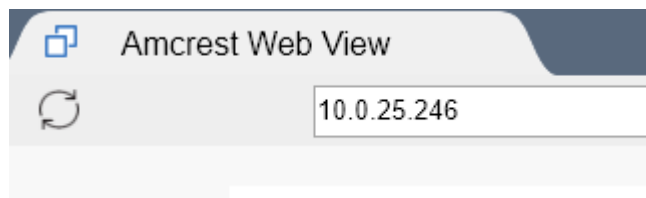

In the web user interface, enter the login credentials for your device. If this is the first time accessing the device, the username and password will both be **admin**. Click on **Login**.

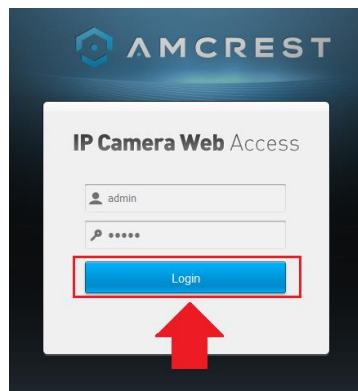

If this is the first-time logging into your device, you will be prompted to modify the password for your device. To modify the password, enter the new password you would like to use in the **New Password** field and confirm. The password used should be between 8 and 32 characters long with a combination of letters and numbers. Click **Ok** when done to log into the web user interface.

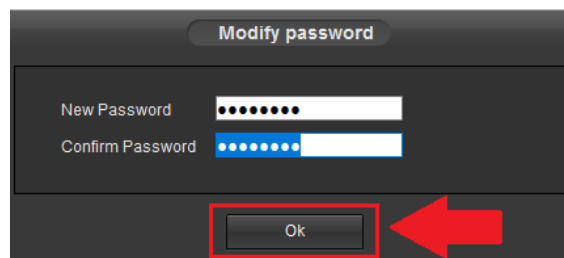

The app will then show the live feed of your connected device in the web user interface.

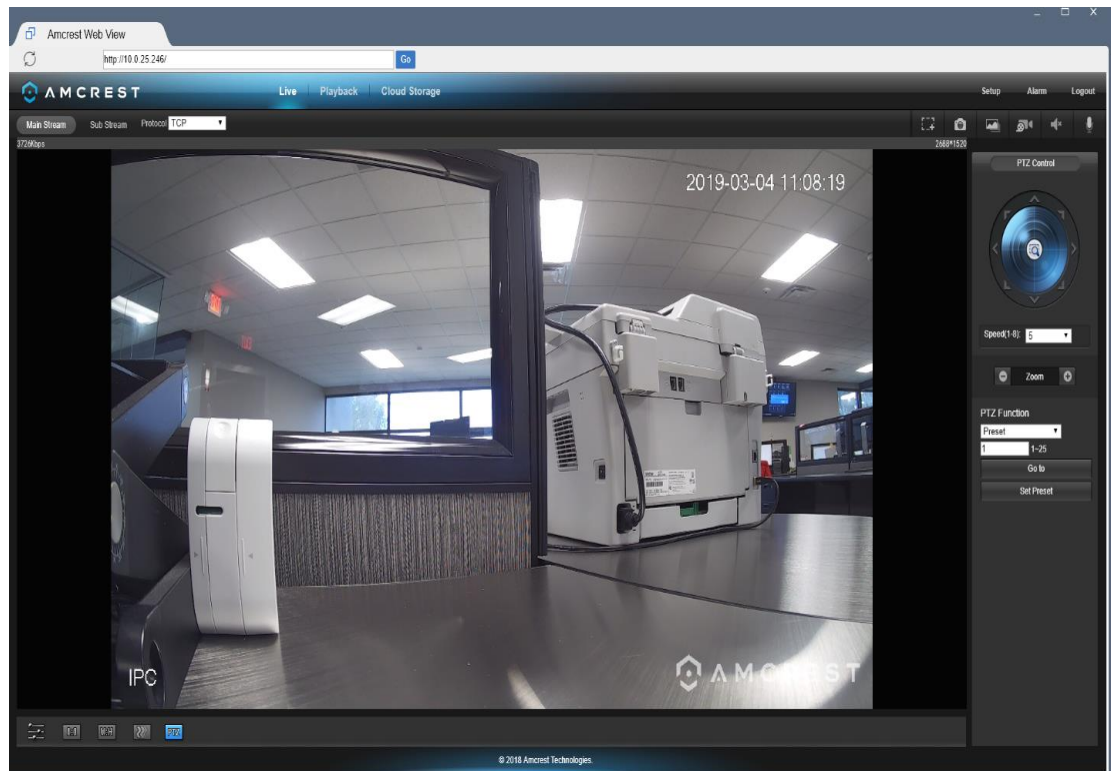

For more information on the web user interface and the features it provides, please refer to the user manual for your device. User manuals can be found at amcrest.com/support or on the original listing of your device.

How to Access a Device Using Firefox

The latest update of Mozilla Firefox will be discontinuing the use of plugins which may cause issues with accessing the web user interface for your device while using Firefox. The plugin will affect the ability to view and playback, however, setting changes will still be available using this method on most devices.

We are currently working on a more permanent solution to the issue but currently, we recommend using a previous version of Firefox such as Firefox 49.0.2. For more information on how to revert to Mozilla Firefox 49.0.2. refer to the instructions provided below.

Reverting to FireFox 49.0.2.

To use the Firefox web browser with your device a previous version, such as 49.0.2. is recommended. You can download the previous version of Firefox by clicking [here](#). To revert to this version, click on the .exe file provided and then click “**Run**” to begin downloading.

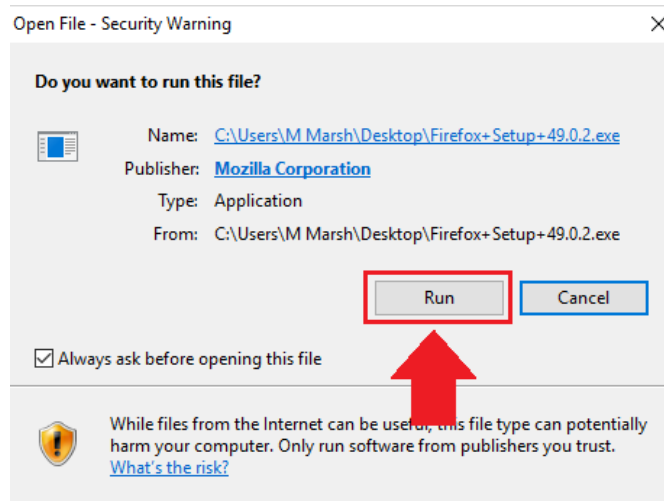

The file will then begin to extract the setup Wizard. Click **Next** to continue the process.

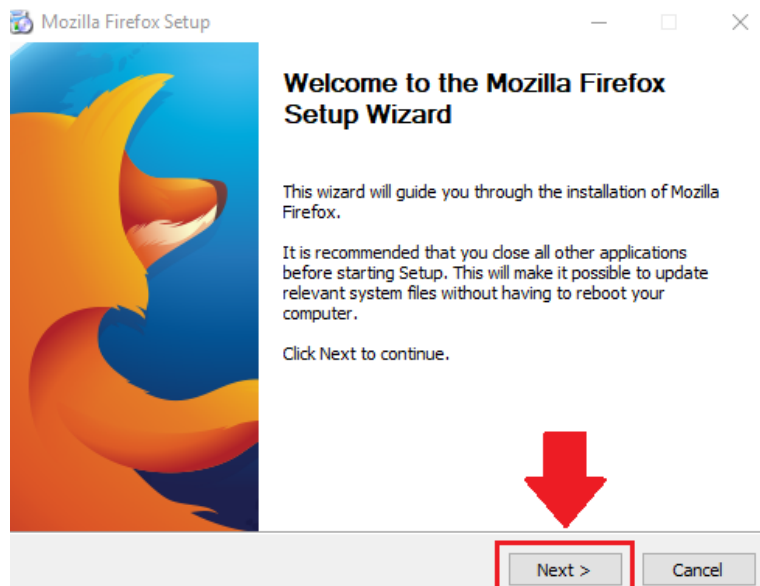

Choose the type of setup you prefer. There are two types of setup, **Standard** and **Custom**. In this case, it is recommended to run the standard setup since it is the most common. This is selected by default in the wizard. To continue, click the **Next** button.

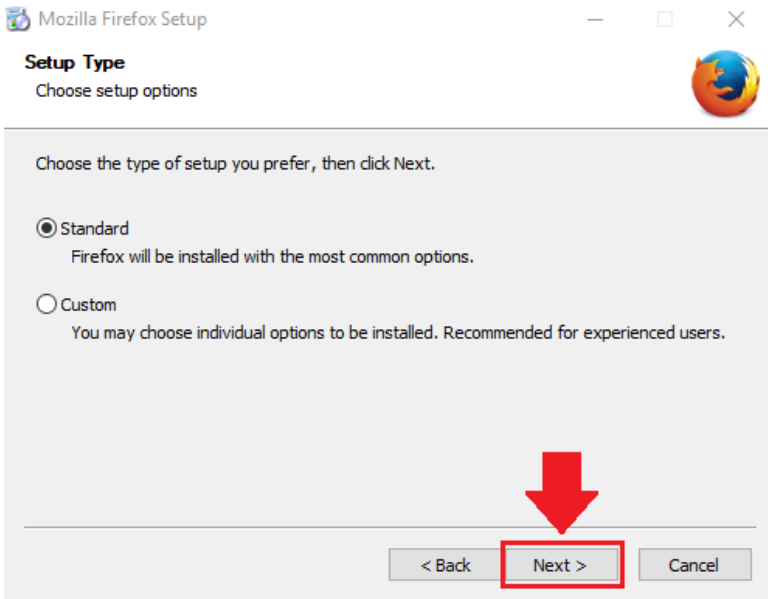

The wizard will then prompt you to install the software onto your computer. Click the **Install** button to install the browser.

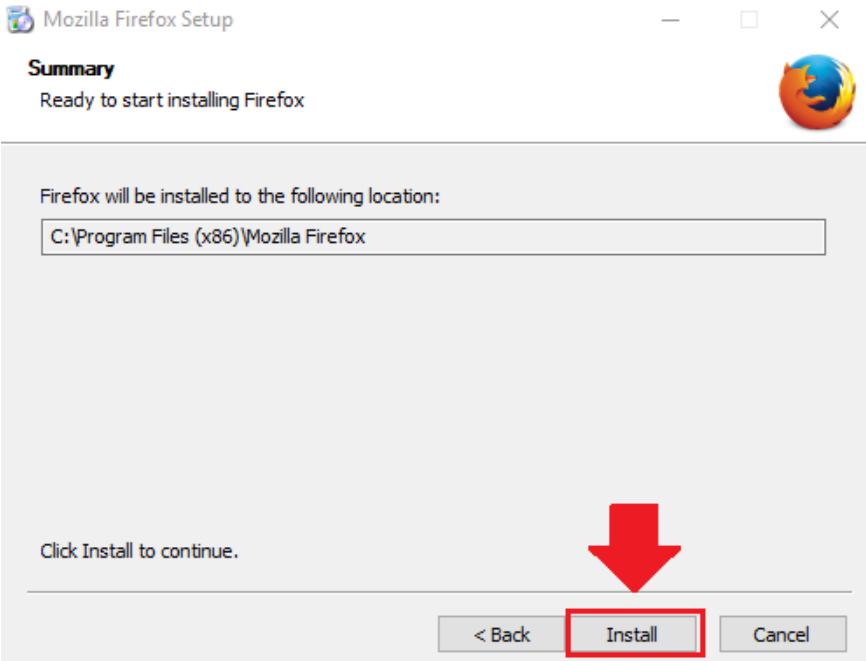

When the installation is complete, click on the finish button to automatically launch the browser.

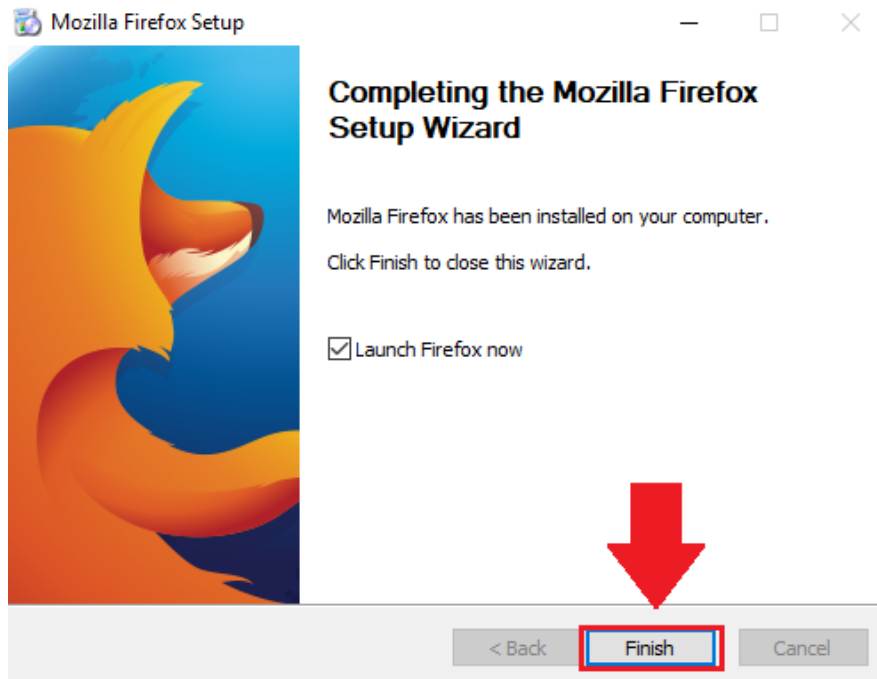

A shortcut icon will also be displayed on your desktop for quick access to the browser if necessary.

Preventing Automatic Updates

Once the browser has finished loading, it is recommended to make sure that no future automatic updates are applied to the browser. If an automatic update were to occur, the browser will revert to the most current version of the FireFox web browser which will prevent the use of plugins on your browser. To prevent automatic updates from occurring, please refer to the following:

In the web browser, click on the settings  menu located at the top of the screen. Then in the settings menu, click on the **Options** icon.

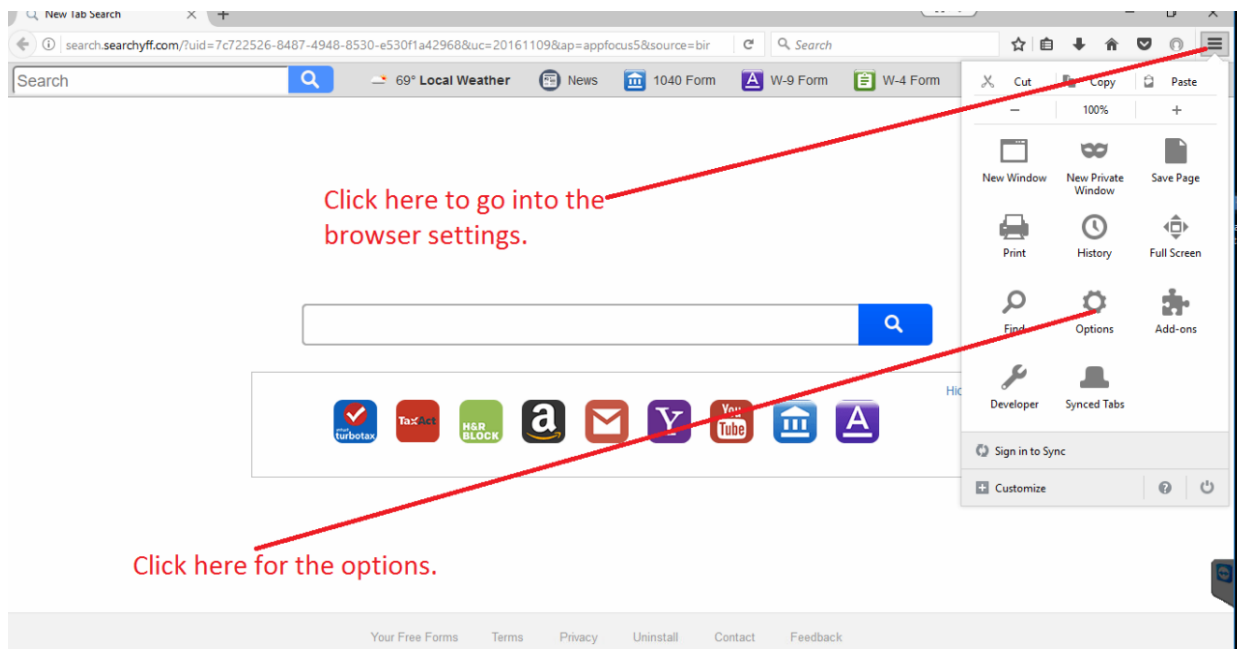

In the options menu, click on **Advanced** and then click on the **Update** tab. In the update tab, select the **Never check for updates** radio button. This will deactivate your browser from obtaining any future updates of the browser.

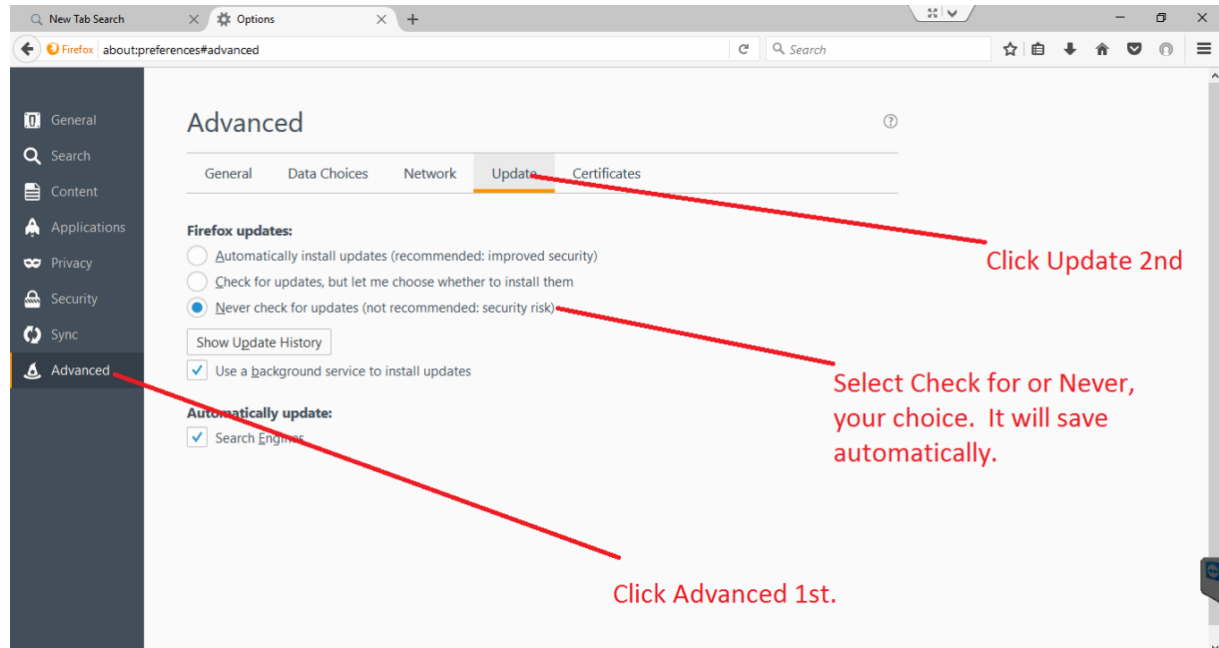

How to Access the Web User Interface Using FireFox

Before accessing your device using Mozilla Firefox, ensure you are using the correct version of Firefox. As discussed previously, later versions of Firefox may prevent the use of plugins which are needed to access your device.

Verify the Correct Version of Firefox is Being Used

To verify the correct version is being used, click on the settings  menu located at the top of your screen and click on the help  menu at the bottom of the settings menu

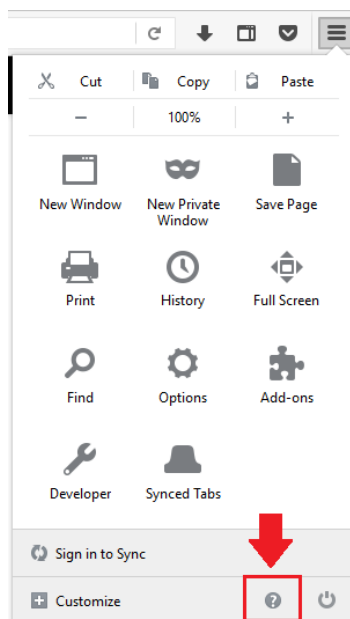

In the help menu, select **About Firefox**

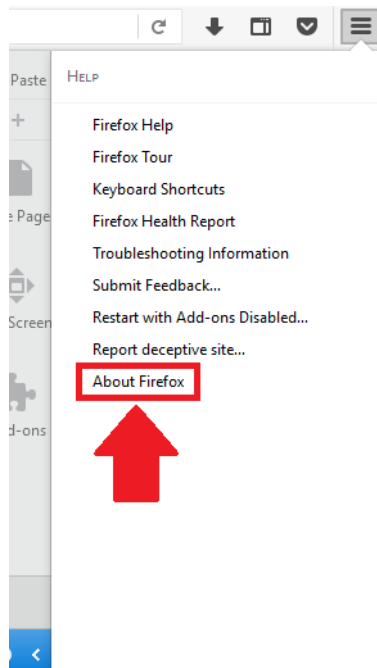

The version being used will be displayed in the **About Mozilla Firefox** menu as displayed in the image below.



It is recommended to use version 49.0.2. **Do not click on Restart Firefox to Update.** This will update the browser and cause the plugins not to work on the browser.

Accessing the Web User Interface

To access the web user interface, locate the IP address for your device using the Amcrest IP Config Tool. The Amcrest IP Config Tool can be downloaded at the following web page: amcrest.com/downloads

In the **All Downloads** menu, click on **IP Config Software** to begin the free download. Once the download has completed installing, locate the IP address associated with the device you would like to view in the browser.

No.	Type	Model	IP	TCP Port	HT
1	IPC	IP4M-1051	10.0.25.246	37777	80

Enter this IP address into the Firefox web browser to load the web user interface.

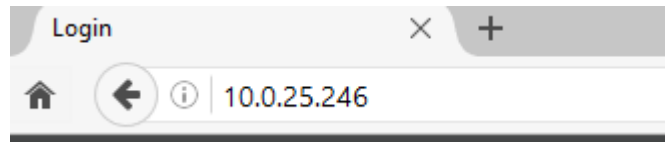

In the web user interface, enter the login credentials for your device. If this is the first time accessing the device, the username and password will both be **admin**. Click on **Login**.



If this is the first-time logging into your device, you will be prompted to modify the password for your device. To modify the password, enter the new password you would like to use in the **New Password** field and confirm. The password used should be between 8 and 32 characters long with a combination of letters and numbers. Click **Ok** when done to log into the web user interface.

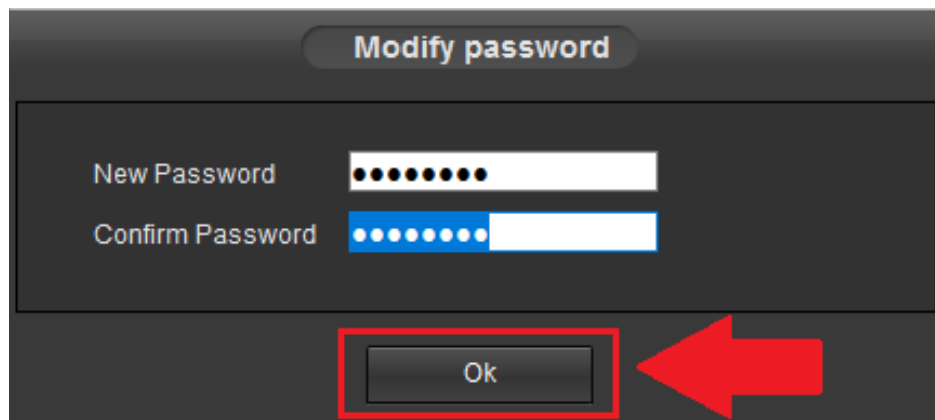

To view your device on the browser you will need to download the plugin. To download the plugin, click on the **Please click here to download and install the plugin** prompt in the middle of the screen.

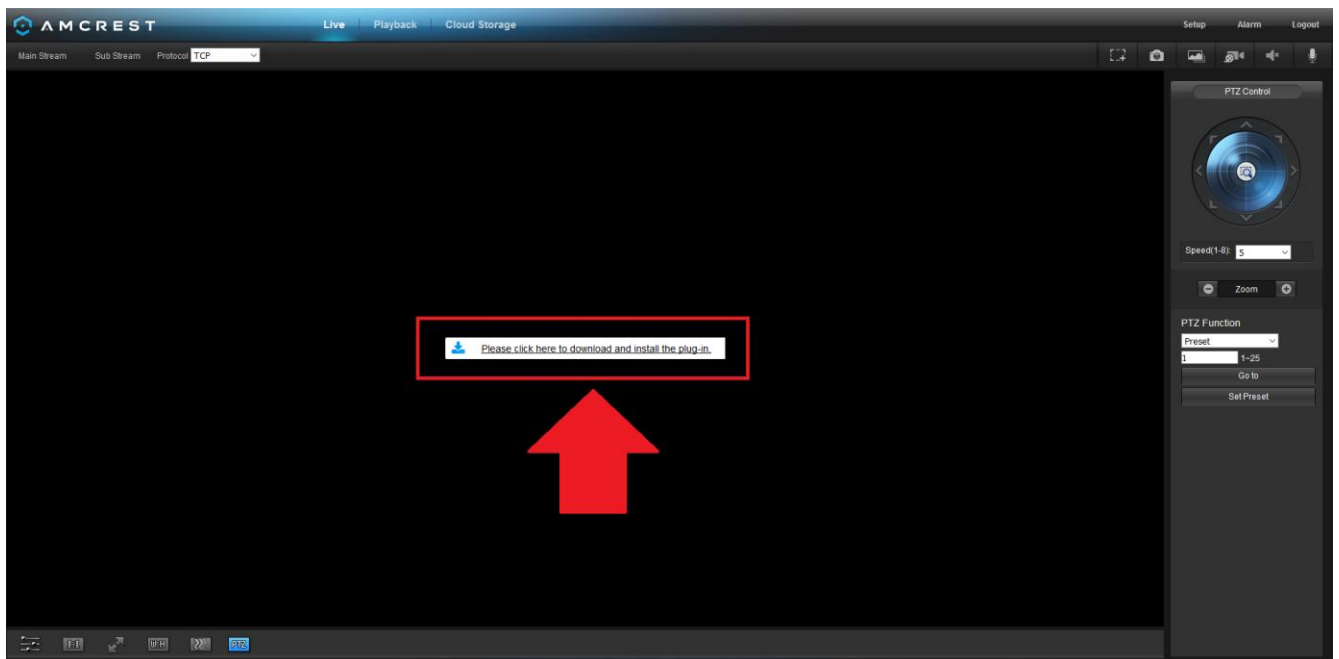

Click on **Save File** to begin downloading the plugin.

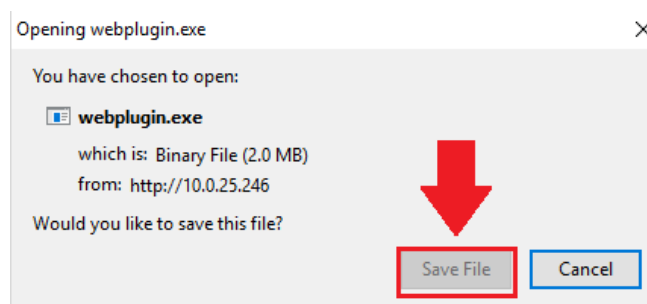

The webplugin.exe file will save to your downloads folder. To install the plugin, click on the downloads  icon and click on the webplugin.exe to install the plugin on your computer.

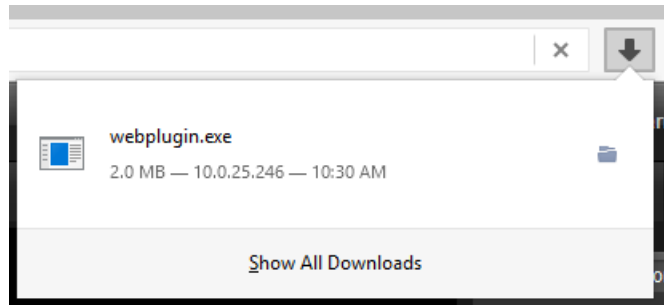

After the web plugin has been installed, close out of the browser completely and then reopen the browser. Type in the IP address for your device into the browser and log into the web user interface with your device's login credentials. Click on the **Activate MMX** icon in the middle of the screen to activate the plugin.

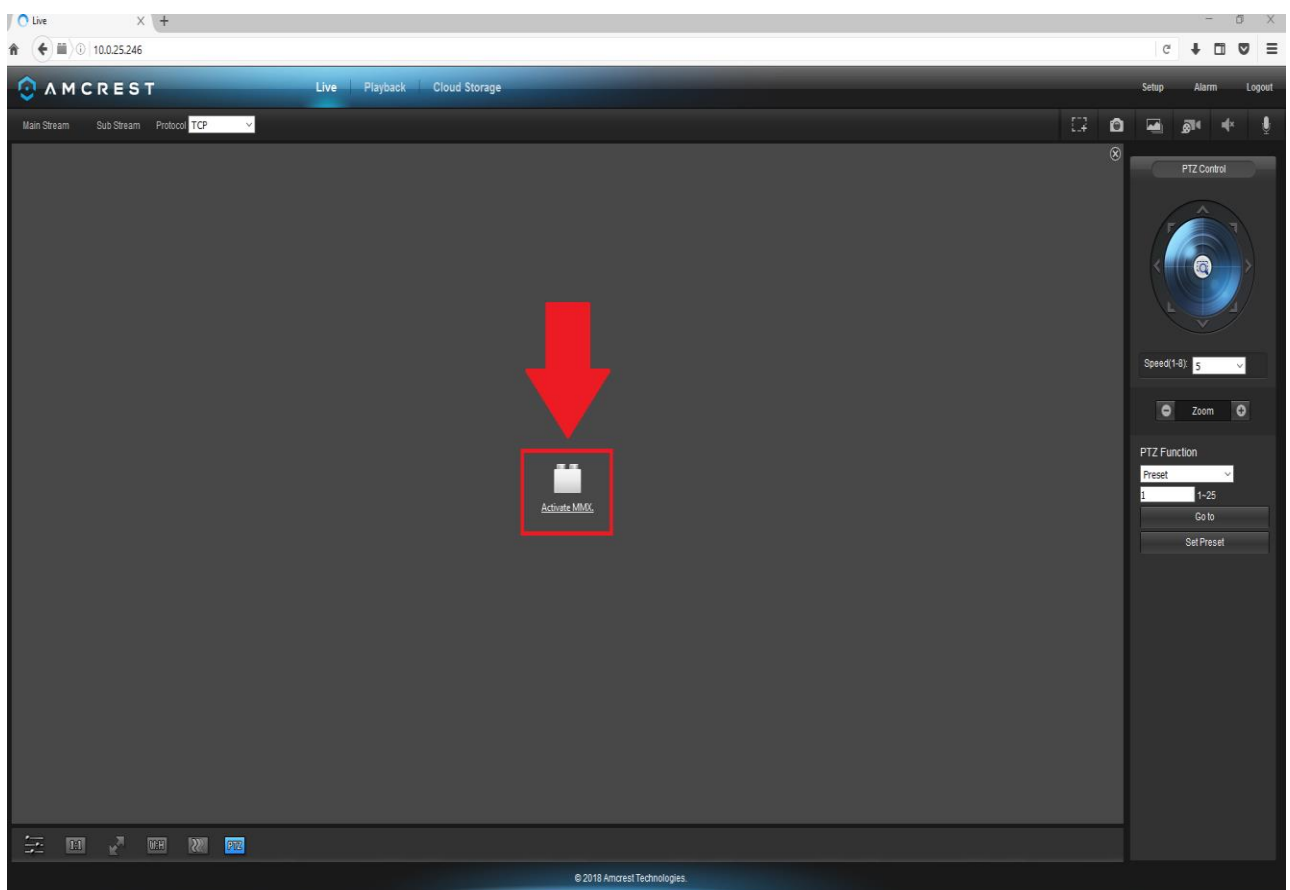

The browser will then need to run the MMX plugin. Click on **Allow and Remember** to allow the browser to run the MMX plugin.

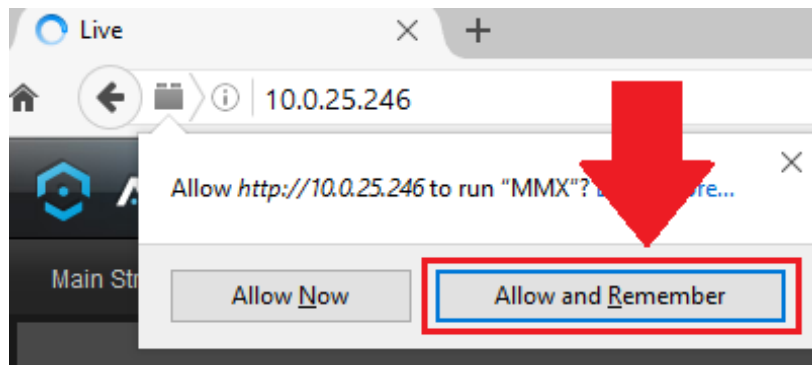

The browser will then show the live feed of your connected device in the web user interface.

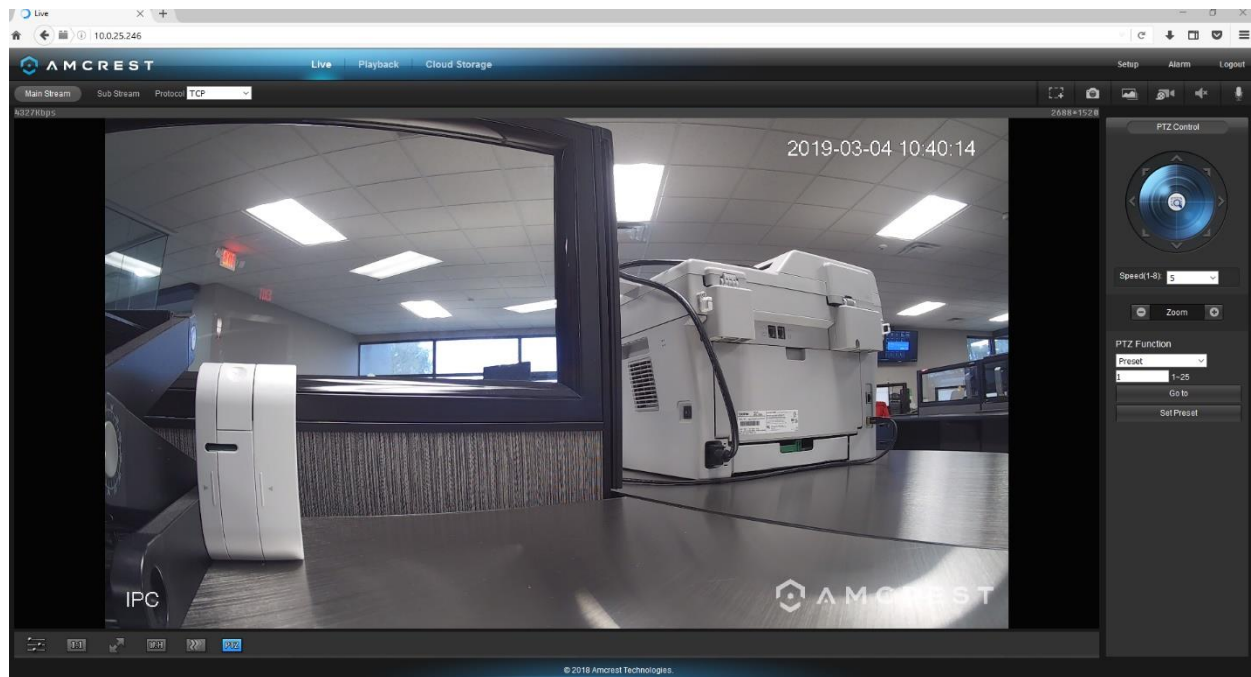

For more information on the web user interface and the features it provides, please refer to the user manual for your device. User manuals can be found at amcrest.com/support or on the original listing of your device.

How To Access the Web User Interface Using Internet Explorer

To access your device using the Google Chrome Extension please refer to the information provided below.

Locate the IP address for your device using the Amcrest IP Config Tool. The Amcrest IP Config Tool can be downloaded at the following web page: amcrest.com/downloads

In the **All Downloads** menu, click on **IP Config Software** to begin the free download. Once the download has completed installing, locate the IP address associated with the device you would like to view in the browser.

No.	Type	Model	IP	TCP Port	HT
1	IPC	IP4M-1051	10.0.25.246	37777	80

Enter this IP address into the Internet Explorer browser and press enter to load the web user interface.



In the web user interface, enter the login credentials for your device. If this is the first time accessing the device, the username and password will both be **admin**. Click on **Login**.



If this is the first-time logging into your device, you will be prompted to modify the password for your device. To modify the password, enter the new password you would like to use in the **New Password** field and confirm. The password used should be between 8 and 32 characters long with a combination of letters and numbers. Click **Ok** when done to log into the web user interface.

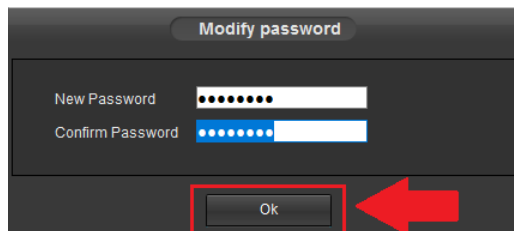

To view your device on the browser you will need to download the plugin. To download the plugin, click on the **Please click here to download and install the plugin** prompt in the middle of the screen.

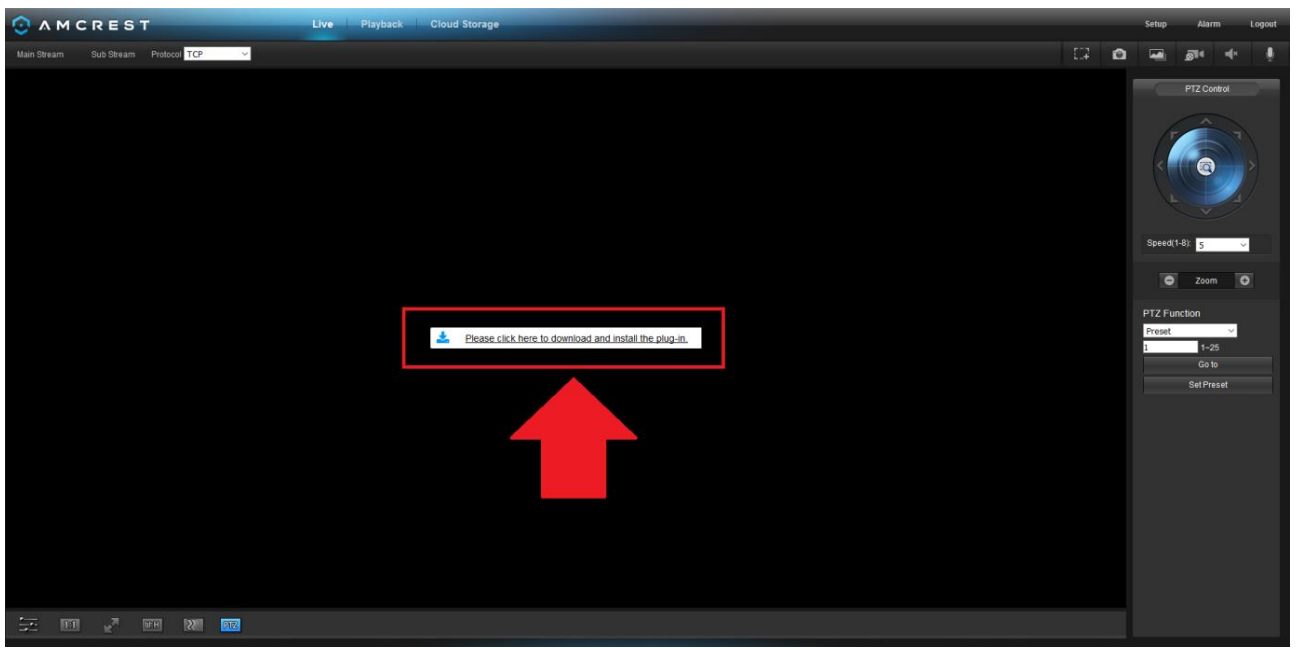

Click **Run** to download the plugin.



The browser will then show the live feed of your connected device in the web user interface.

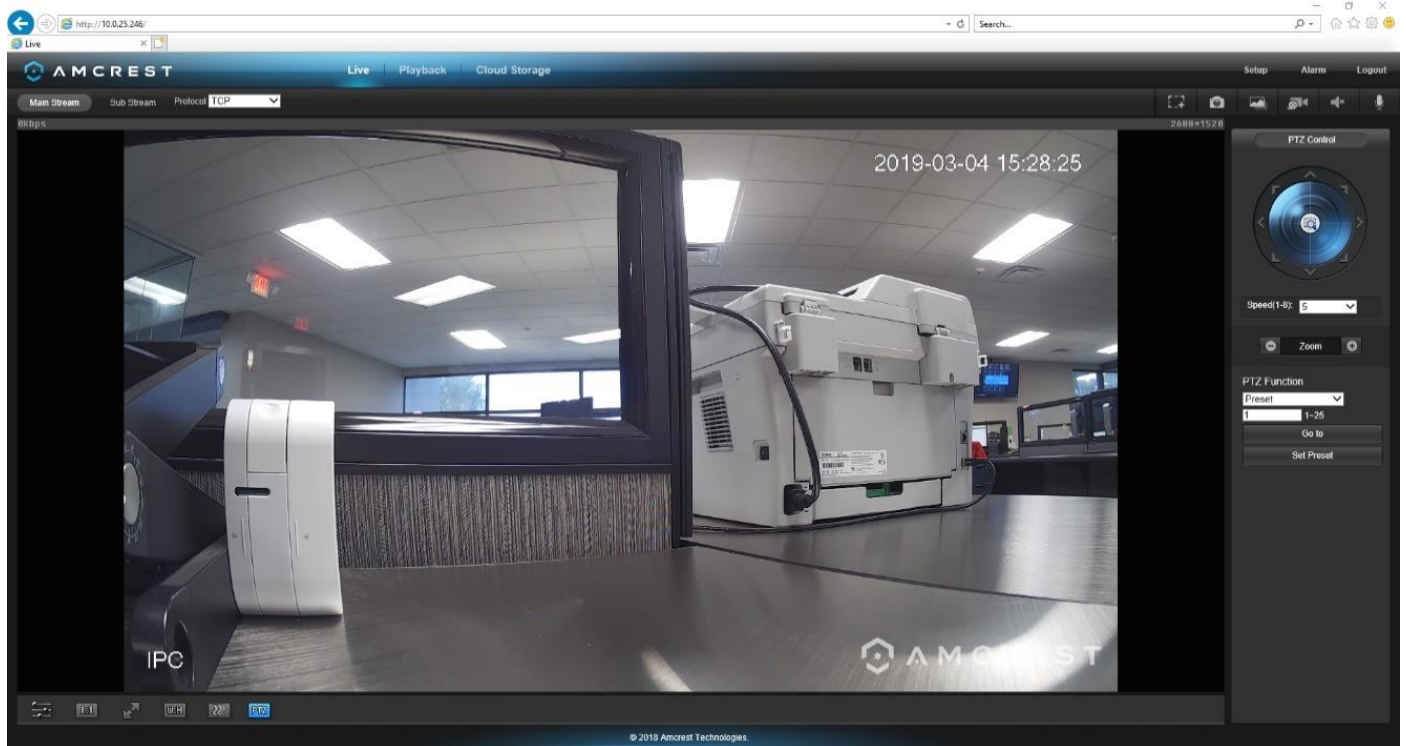

4.4.4. Remote Web Access Setup

There are two main methods for setting up remote access: UPnP/DDNS, and Port Forwarding.

UPnP/DDNS Remote Web Access Setup

Using Universal Plug and Play (UPnP) and Dynamic Domain Name Server (DDNS) functionality is the easiest way to setup stable remote access. For this method, your router should support the uPnP networking protocol and the protocol should be enabled. Please refer to your router manufacturer's documentation to learn how to enable uPnP on your router.

Below is a step-by-step walkthrough that details how to setup Amcrest cameras for Remote Web Access using UPnP and DDNS:

1. Login to your camera's web interface, open the main menu then go to Setup -> Network.
2. Using the left-hand menu, go to the Connection menu, and write down the HTTP port. It is recommended to ensure the port number is at least 5 digits long to prevent any port conflicts. If need be, change the port to a 5-digit number that is less than 65535, note the number down, and click save before proceeding to the next step.
3. The system will prompt you to reset the camera. Click OK and wait for the camera to restart.
4. Restarting the camera may cause the device to use another IP address. Use the included IP Config tool to find the IP address as detailed previously in this document.
5. Login to your camera, open the main menu then go to Setup -> Network.
6. Click the Connections menu item on the left-hand menu and ensure that the HTTP port has changed.
7. Click the DDNS menu item on the left-hand menu, pick Amcrest DDNS from the drop down box, click the checkbox next to Server Type, and then click the Save button on the bottom right.
8. To set a custom DDNS name, fill out the Domain Name field and click Save.
9. Write down the entire Domain Name field, including the white text that says .AmcrestDDNS.com
10. Click the UPnP menu item on the left-hand menu and click the enable checkbox at the top.
11. While in the UPnP menu, double click the HTTP port, and change both the internal and external HTTP ports to match the number that was used in step 2.
12. Uncheck the last 4 checkboxes in the PAT table on the UPnP menu.
13. Click apply, then exit this menu to go back to the main menu, then re-enter the UPnP menu, and ensure the UPnP status says, "Mapping Successful".
14. Open a web browser and enter in the DDNS domain name address from step 9, enter in a colon, then type the port number from step 4 on to the end.
 - a. For example, if the DDNS domain name is `http://abc123456789.AmcrestDDNS.com` and your HTTP Port is 33333, the URL would be `http://abc123456789.AmcrestDDNS.com:33333`
15. The browser may prompt you to install a plugin. Click install to download the plugin, and then click on the plugin installation file to install the plugin.
16. If the browser prompts you to allow the plugin to work on the computer, hit Allow to ensure the plugin can run successfully.
17. Enter in login details into the username and password fields and click login.

If the process above is not working, please contact Amcrest Support via one of the following options:

Visit [http://amcrest.com/contacts and use](http://amcrest.com/contacts_and_use) the email form.

Call Amcrest Support using one of the following numbers

Toll Free: (888) 212-7538

International Callers (Outside of US): +1-713-893-8956

USA: (888) 212-7538

Canada: 437-888-0177

UK: 203-769-2757

Email Amcrest Customer Support support@amcrest.com



Port Forwarding Remote Web Access Setup

Port Forwarding is an alternative method to setting up remote access for Amcrest cameras. This method should only be used if the UPnP/DDNS Remote Access method did not work.

Below is a step-by-step walkthrough that details how to setup the camera for Remote Web Access using Port Forwarding:

1. Login to your camera, open the main menu then go to Setup -> Network.
2. Open the TCP/IP settings screen.
3. By default, the camera has the mode set to DHCP. Ensure that DHCP is selected. The IP Address, Subnet Mask, Default Gateway, Preferred DNS, and Alternate DNS should all be 0s if DHCP is selected.
4. Click Save to save these settings. This should now open the main menu.
5. From the main menu, go to **Setup -> Network**.
6. On the TCP/IP settings screen, the IP Address, Subnet Mask, Default Gateway, Preferred DNS, and Alternate DNS should all be populated.
7. Click the radio button next to Static, to change the mode to Static.
8. Write down the IP Address that is currently in the IP address field.
9. Click the **Save** button.
10. Using the left hand menu, go to the Connection menu, and write down the TCP, UDP, and HTTP port number. It is recommended to ensure that these port numbers are at least 5 digits long to prevent any port conflicts. If need be, change each of these port numbers to a 5-digit number that is less than 65535, note the numbers down, and click save before proceeding to the next step.
11. Go to <http://www.canyouseeme.org/> and check to ensure each of the port numbers specified in step 10 is open.
12. Write down the manufacturer name, brand, and model name for the router that the camera is connected to, and then proceed to <http://www.portforward.com> on your web browser.
13. Open the port forwarding guide section on the left-hand side menu.
14. Find the router brand name in the list and click it.
15. Find the router model number and click it.
16. Click the Default Guide link near the middle of the page.
17. This guide will help you take the step necessary to port forward on the router. Follow these steps, and then return to the camera.
18. Login to your camera, open the main menu then go to Setup -> Network.
19. Click the DDNS menu item on the left-hand menu, pick AMCRESTDDNS from the drop-down box, click the checkbox next to Server Type, and then click the Save button on the bottom right.
20. To set a custom DDNS name, fill out the Domain Name field and click Save.
21. Write down the entire Domain Name field, including the white text that says .AmcrestDDNS.com
22. Open a web browser and enter in the DDNS domain name address from step 21, enter in a colon, then type the HTTP port number from step 10 on to the end.
For example, if the DDNS domain name is <http://abc123456789.AmcrestDDNS.com> and your HTTP Port is 33333, the URL would be <http://abc123456789.AmcrestDDNS.com:33333>
23. Enter in login details into the username and password fields and click login.

If the process above is not working, please contact Amcrest Support via one of the following options:

Visit <http://amcrest.com/contacts> and use the email form

Call Amcrest Support using one of the following numbers

Toll Free: (888) 212-7538

International Callers (Outside of US): +1-713-893-8956

USA: (888) 212-7538

Canada: 437-888- 0177

UK: 203-769-2757

Email Amcrest Customer Support support@amcrest.com

4.5 Amcrest Cloud Desktop Setup

Amcrest cameras can sync with Amcrest Cloud; a service that stores recorded video streams to enable long-term storage. Amcrest Cloud also allows the user to easily find and download recorded video for playback from any internet connected PC or Mac computer.

For more information on how to setup your camera on Amcrest Cloud on the web, visit amcrest.com/cloudwebsetup or follow the steps provided below:

1. Connect the camera to power and wait 30 seconds for the camera to start-up and initialize.
2. Using a web browser on your PC or Mac, visit www.amcrest.com/cloud and register for a cloud account. Once registered, click the “**Add Camera**” button. Select “Amcrest”, give the camera a name, and enter the camera’s SN (located on the bottom of the camera), then click “Next”.
3. On the settings page, you can adjust optional preferences for your camera. Once settings have been adjusted, click “Finish”. Your camera is now successfully set up for cloud access and storage.
4. View your camera live or watch recorded clips using the menu button on the top of the page. You can also use the Amcrest Cloud app on iOS and Android to add more cameras, play recordings, and view your camera live, from anywhere. For more information visit amcrest.com/support
5. For additional assistance, please contact us at www.amcrest.com or give us a call at 1-888-212-7538. Step by step video tutorials available at <http://www.amcrest.com/videos>

4.6 Web Access Setup (AmcrestView.com)

1. Connect the camera to power and wait 30 seconds for the camera to start-up and initialize.
2. Using Internet Explorer or Safari, go to www.AmcrestView.com and register an account. You will be required to activate your account by e-mail (double-check your spam folder).
3. Once activated, download and install the plugin for your web browser. The installation of the plugin will require all web browsers to close.
4. Log in to your account. To add a camera, click the “Add Device” button. Give the camera a name, enter the UID (found on the bottom of your camera), then enter the login details for the camera. The default username and password for the camera is admin.
5. Once added, the camera should appear in the device list. Click the  icon next to the camera’s UID to open the live viewing and playback interface.
6. The device is now successfully setup for live viewing and playback!

For additional assistance, please contact us at www.amcrest.com or give us a call at 1-888-212-7538. Step by step video tutorials available at www.amcrest.com/videos

5 Operation and Interface

This section of the manual details the camera’s interface, as well as all the operations the camera can perform.

As previously stated, to access the web user interface for your device, it is recommended to use the free Amcrest IP Config tool. The Amcrest IP Config tool can be found by visiting, amcrest.com/downloads.

Amcrest IP Config Tool

No.	Type	Model	IP	TCP Port	HTTP Port	Subnet Mask	Gateway	MAC	SN	Version	Operate
1	IPC	IP8M-2493E	10.0.2.22	37777	7063	255.0.0.0	10.0.0.1	9c:8e:cd:16:b1:...	AMC041F25...	2.460.AC...	⚙️ 🌐 🌐
2	IPC	IP8M-2496E	10.1.0.14	37777	4601	255.0.0.0	10.0.0.1	9c:8e:cd:17:ab:...	AMC046889...	2.460.AC...	⚙️ 🌐 🌐
3	IPC	IP8M-2496E	10.0.31.166	3063	3026	255.0.0.0	10.0.0.1	9c:8e:cd:17:d9:...	AMC046D3E...	2.460.AC...	⚙️ 🌐 🌐
4	IPC	IP8M-2454E	10.0.31.248	37777	4602	255.0.0.0	10.0.0.1	9c:8e:cd:1a:d2:...	AMC0485C2...	2.460.AC...	⚙️ 🌐 🌐

After launching the IP Config tool, click the **Refresh** button to bring up the cameras on the network.

Double click the camera’s line item to login and connect to the camera. Once logged in, click the  icon to open the camera’s interface in a web browser.

Log in to the camera using your login credentials (default username and password are both “admin”). If this is your first-time logging into the camera, you will be prompted to change your password. Please select a password that is at least 8 characters long, and one that uses a combination of uppercase letters, lowercase letters, and numbers.

When opening the camera’s interface, the browser may prompt you to install a plugin. The plugins are necessary for using the camera’s interface. Click install to download the plugin, and then click on the plugin installation file to install the plugin. If the browser prompts you to allow the plugin to work on the computer, hit Allow to ensure the plugin can run successfully.

The camera is now successfully set up for live viewing!

For quick and easy remote access on your PC or Mac, please use amcrestcloud.com (section 4.5) or amcrestview.com (section 4.6).

For additional assistance, please contact us at www.amcrest.com or give us a call at 1-888-212-7538. Step by step video tutorials available at <http://www.amcrest.com/videos>

The main interface of the camera contains 6 major tabs on the top of the screen. By default, the interface opens on the Live tab.

5.1. Live



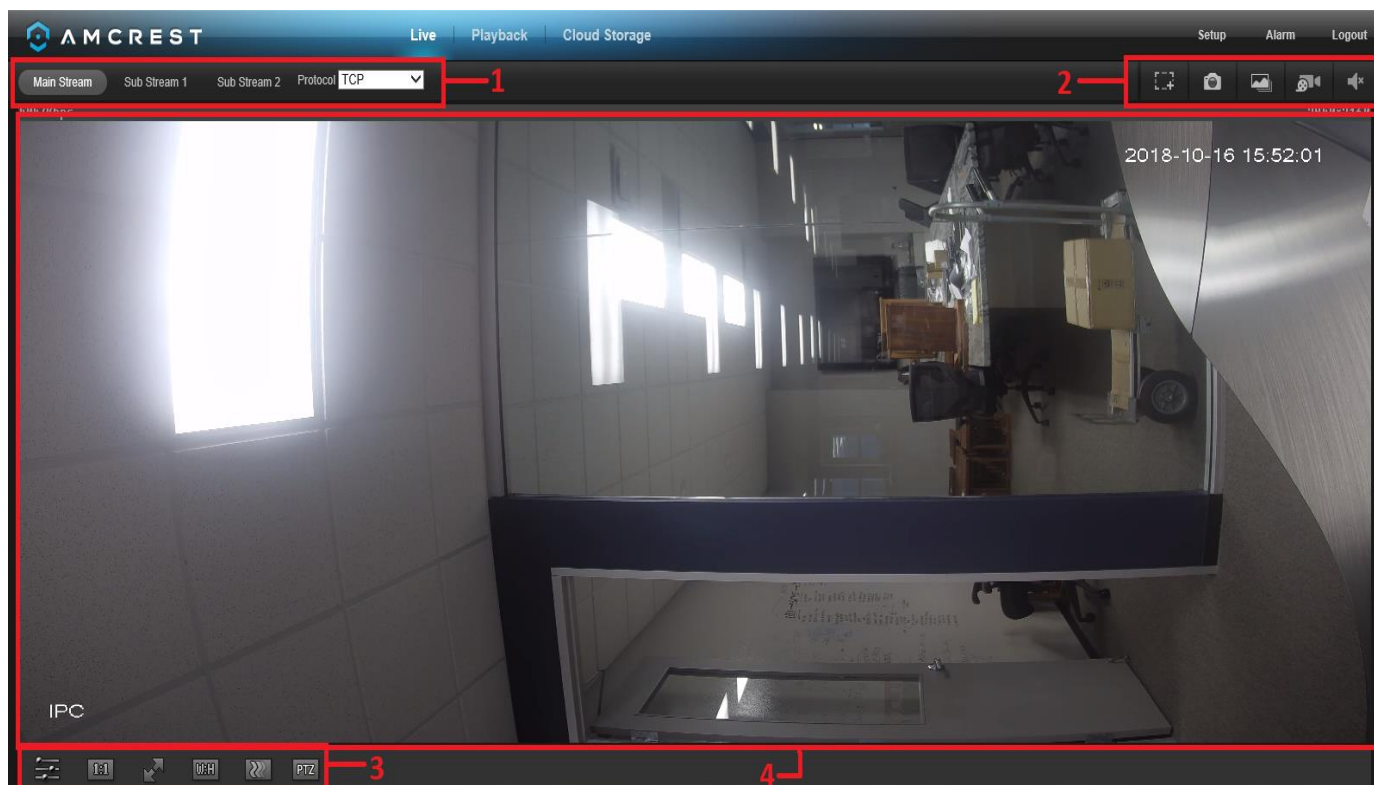

This section of the manual details the camera’s interface, as well as all the operations the camera can perform.

The live view tab allows the user to see a live video feed from the camera. The live view tab has five main sections:







Section 1: This bar allows the user to select which stream type and which protocol they want to choose.

Section 2: The functions bar allows the user to perform different camera functions while in live mode. See the table below for an explanation of the different functions available:

Button	Function Name	Function Description
	Optical/Digital Zoom	Click this button to activate the zone selection function. This allows the user to use the mouse to select a zone to zoom in on.
	Snapshot	Click this button to take a screenshot of the live feed. The picture is saved at the path specified in Setup -> Camera -> Video -> Path.
	Triple Snapshot	Click this button to take 1 screenshot per second for 3 seconds. The pictures are saved at the path specified in Setup -> Camera -> Video -> Path.
	Manual Record	Click this button to manually record video. The video is saved at the path specified in Setup -> Camera -> Video -> Path.
	Audio	Click this button to enable or disable audio output from the camera. This feature allows the user to listen in on the audio the camera's microphone is picking up.

Section 3: This bar allows the user to change video settings for the live playback screen. See the below table for an explanation of the video settings:

Button	Function Name	Function Description
	Image Adjustment	This button opens the image adjustment toolbar, which allows the user to adjust brightness, contrast, saturation, and hue for the live feed's picture.
	Adapt/Original Size	This button allows the user to switch between displaying the original size of the stream in its set resolution, or to adapt to the size of the monitor display the feed is being viewed on.
	Full Screen	This button allows the user to make the live feed go into full screen mode. Double click the mouse or click the ESC button to exit full screen mode.
	Width/Height Ratio	This button allows the user to change the width/height ratio for the live feed. The options are Original and Adaptive. Original uses the aspect ratio of the stream's set resolution, and adaptive fits the feed to the aspect ratio of the monitor display the feed is being viewed on.
	Stream Fluency	This button allows the user to change the stream fluency. There are 3 options. Realtime reduces delay and decreases fluency, and Fluency has a larger delay, but the video stream becomes more fluid.

Section 4: This section of the Live tab shows the picture that the camera is broadcasting. The bitrate is shown in the top left corner, the native resolution is shown in the top right corner, the time stamp is shown below the native resolution, and the camera type is shown in the bottom left corner.

5.2 Playback

The Playback tab allows the user to playback the camera's recorded video. Below is a screenshot of the Playback tab:

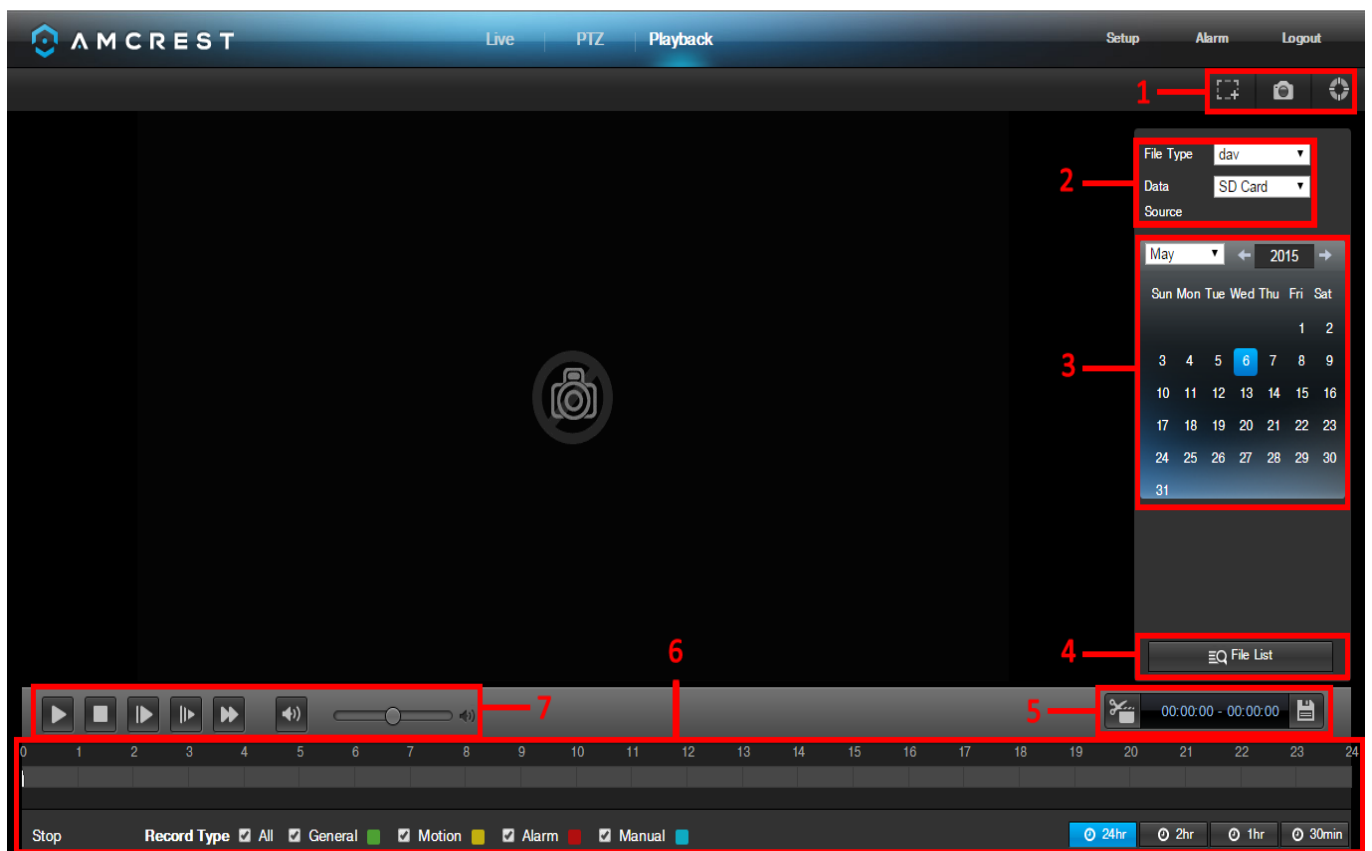

This is the interface for the playback menu. There are 7 main sections:

1. **Quick Actions:** This panel allows the user to zoom in on playback footage, take a snapshot of the playback footage, or open the help menu.
2. **File Menu:** This panel allows the user to select a file type and data source.
3. **Calendar:** This panel allows the user to pick a date that they would like to playback video from. When a date has recorded footage available, it's green. The current date is blue, unless it has recorded footage, then it's a lighter green.
4. **File List:** This button opens a file list of all recorded video for a specific date range. From here, the user can download these videos to their PC.
5. **Trim Panel:** This panel allows the user to trim playback video for download. By specifying time stamps, the user can trim down.
6. **Recorded Video Panel:** This panel allows the user to specify what type of video they would like to playback and it also allows the user to select where to start playback from. The buttons on the bottom right allow the user to select a zoom level.
7. **Playback Bar:** This panel allows the user to control playback. It also allows the user to control playback speed, and playback volume.

Clicking the File List opens the following screen on the sidebar:

This allows the user to select files for download. Select the files by clicking the checkbox next to each file, and then click  to download the files to the PC.

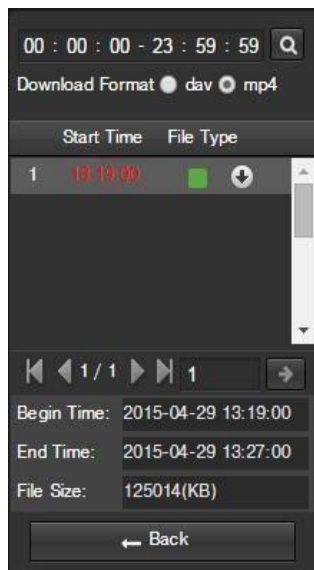

5.3. Cloud Storage

The Cloud Storage tab allows the user quick access to the Amcrest Cloud website.

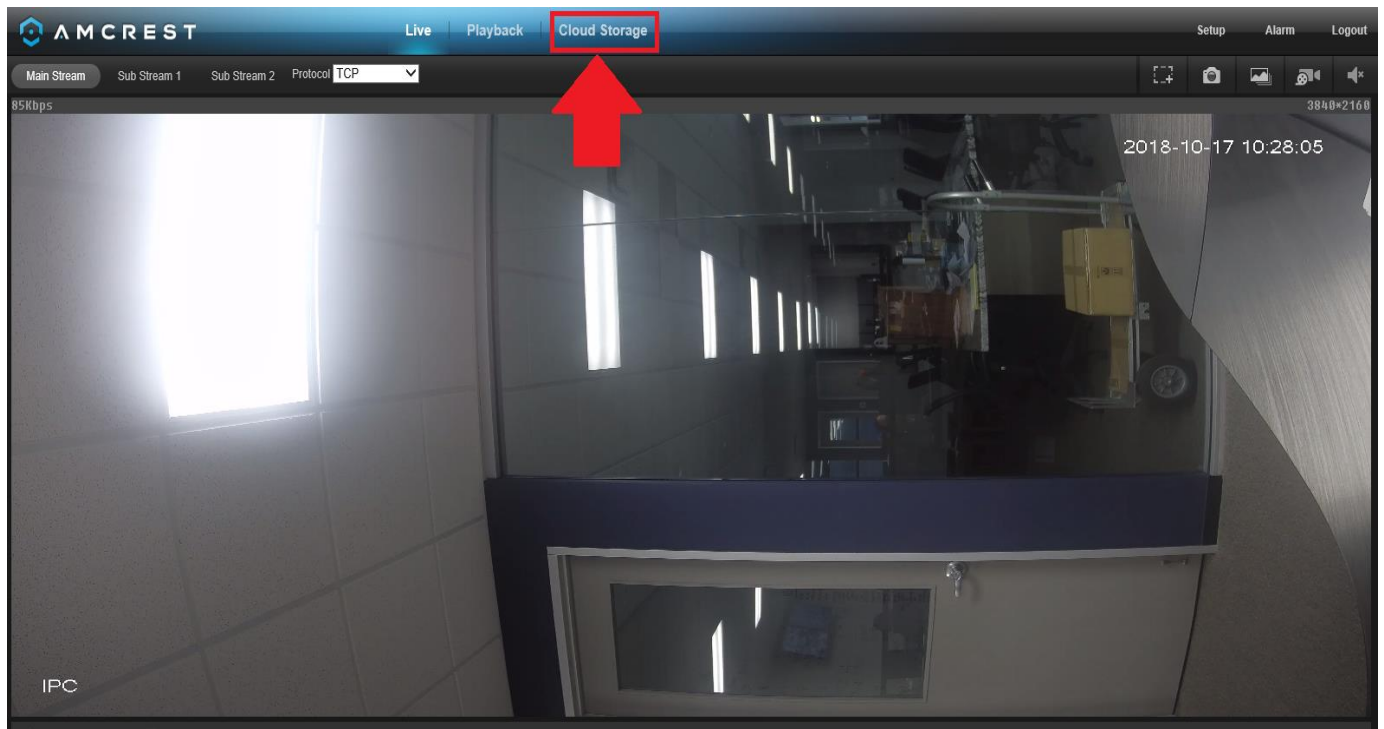

At this website (amcrestcloud.com) users can register for new accounts as well as view or modify existing accounts. For more information on Amcrest Cloud visit: amcrest.com/support

5.4 Setup

The Setup tab allows the user to change different camera settings. Below is a screenshot of the setup tab:

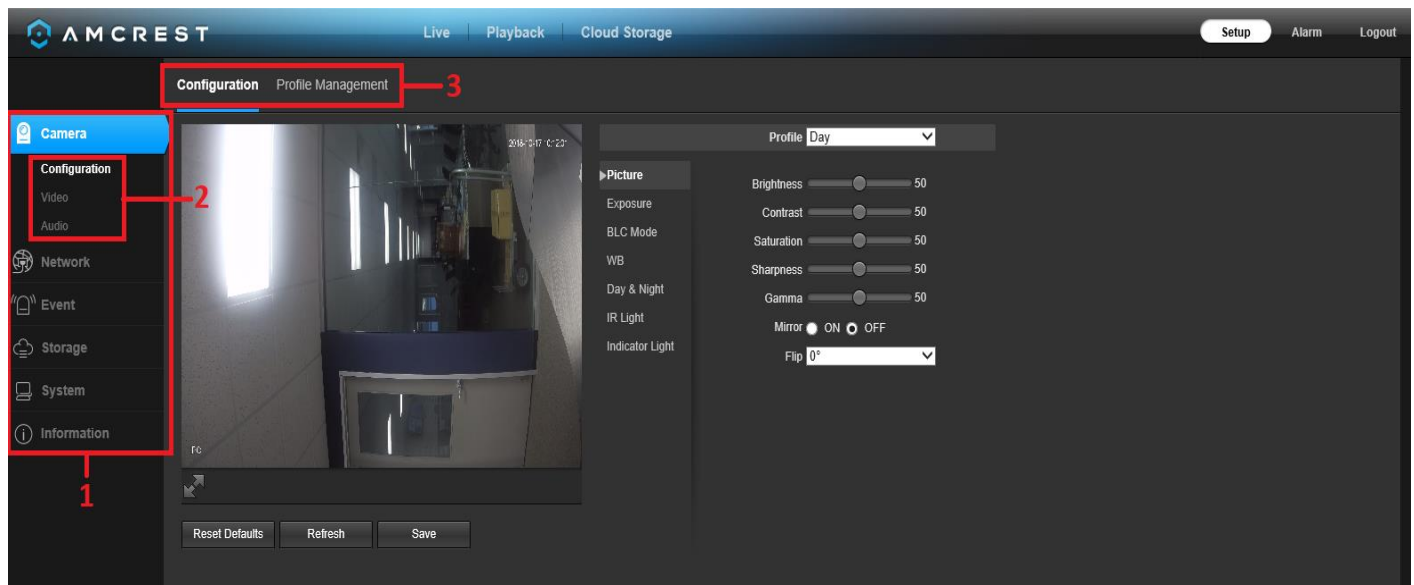

There are 3 main sections to note in the Setup tab:

1. **Menu Bar:** The menu bar is composed of menu sections, which when clicked display any menu items that fall under their category.
2. **Menu Items:** These menu items each open a different menu that allows the user to change specific settings for the camera.
3. **Menu Tab:** These tabs open menu options for certain menu items.

5.4.1. Camera

This menu section allows the user to change different camera settings for video, audio, and to manage image profiles.

5.4.1.1 Configuration

This menu allows the user to configure image profiles for normal, day, and night usage. Below is a screenshot that shows the Configuration tab in the Configuration menu item:

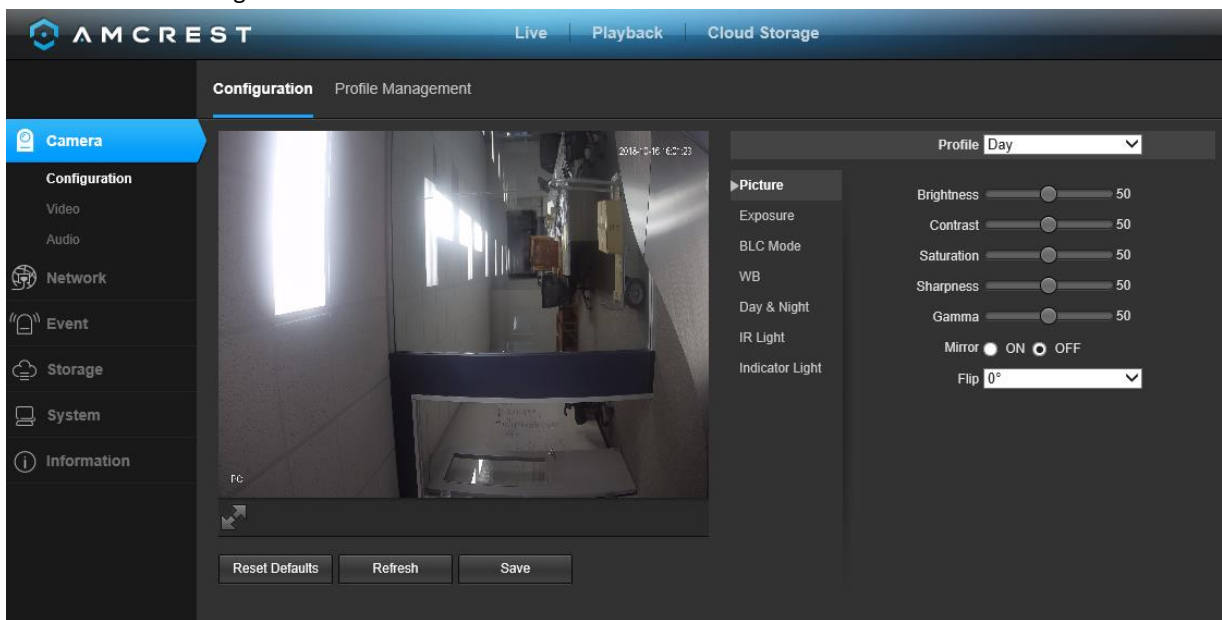

Below is an explanation for each of the fields on the Configuration tab in the Configuration menu item:

5.4.1.1.1. Picture

- **Profile:** This dropdown box allows the user to select which profile to modify. The 3 options are Day, Night, and Normal.
- **Brightness:** This slider is used to adjust playback and recorded video window brightness. The value ranges from 0 to 100. The default value is 50. The larger the number, the brighter the video is. When you input the value here, the bright section and the dark section of the video will be adjusted accordingly. You can use this function when the whole video is too dark or too bright. Please note the video may become hazy if the value is too high. The recommended value ranges from 40 to 60.
- **Contrast:** This slider is used to adjust playback and recorded video window contrast. The value ranges from 0 to 100. The default value is 50. The larger the number is, the higher the contrast is. You can use this function when the whole video brightness is OK but the contrast is not correct. Please note the video may become hazy if the value is too low. If this value is too high, the dark section may lack brightness while the bright section may over expose. The recommended value ranges from 40 to 60.
- **Saturation:** This slider is used to adjust playback and recorded video window saturation. The value ranges from 0 to 100. The default value is 50. The larger the number, the stronger the color is. This value has no effect on the general brightness of the whole video. The video color may become too strong if the value is too high. For the grey part of the video, distortion may occur if the white balance is not accurate. Please note the video may not be clear if the value is too low. The recommended value ranges from 40 to 60.
- **Sharpness:** This slider is used to adjust the sharpness of the video. The value ranges from 0 to 100. The larger the value is, the clearer the edges are and vice versa. Note: The higher the value, the higher likelihood of picture noise occurring. The default value is 50 and the recommended value ranges from 40 to 60.
- **Gamma:** This slider is used to adjust the gamma of the video. The larger the number, the brighter the video is. The default value is 50 and the recommended value ranges from 40 to 60.
- **Mirror:** This radio button allows the user to turn the mirroring feature on or off. Turning mirroring on will mirror the picture.
- **Flip:** This dropdown box allows the user to flip the video feed picture. Flipping the picture is recommended only if the camera is mounted upside down.
 - **Note:** Due to specific limitations cameras 4MP and above will not be able to perform image flips in 90 or 270 degree rotations.

5.4.1.1.2. Exposure

This dropdown box allows the user to select the exposure type for the video feed. The options are Auto, Low Noise, Low Motion Blur, and Manual. When low noise is selected, an additional option to specify a gain range appears below this box. When low motion blur is selected, an additional option to specify shutter speed appears below this box. When manual is selected, additional options to specify a shutter speed and a gain range appear below this box.

Below is a screenshot of the exposure menu:

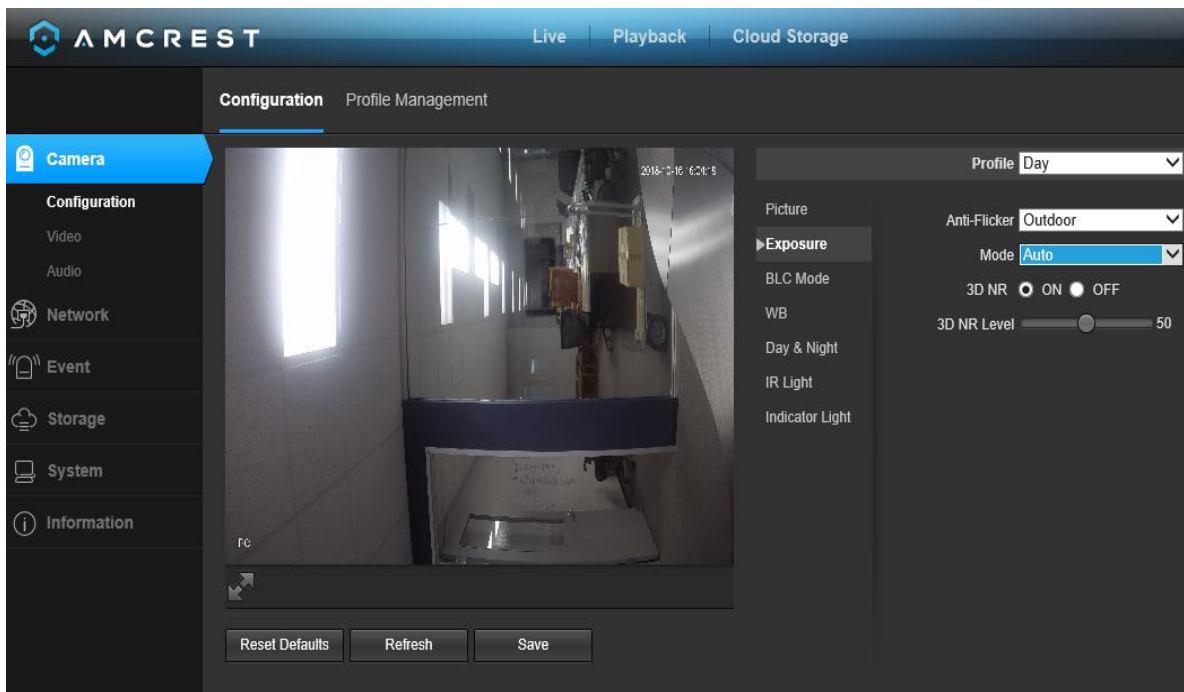

- **Profile:** This dropdown box allows the user to select which profile to modify. The 3 options are Day, Night, and Normal.
- **Anti-Flicker:** These radio buttons allow the user to select what type of anti-flicker technology should be used for the video feed. The three options are 50 Hz, 60 Hz, and Outdoor. The desired option should offset any flickering effect caused by the electrical current used in the specific area.
- **Mode:** This dropdown menu allows the user to modify certain exposure settings related to the device such as, gain priority, shutter priority or setting a manual gain setting.
 - **Gain Priority** - This setting will maximize the gain for the ideal exposure. Low Noise Basically turns up the ISO to the best setting without sacrificing exposure timing.
 - **Shutter Priority** - This setting will maximize the fastest shutter speed and will sacrifice the gain in return.
 - **Manual** - This setting lets you select your shutter speed and have the gain adjust automatically. Selecting customized range will let you both the shutter speed and adjust the gain manually.
- **3D NR:** This radio button allows the user to turn the 3D Noise Reduction feature on or off.
- **3D NR Level:** This slider allows the user to specify the 3D Noise Reduction level. The value ranges from 1-100.

To reset to default settings, click the **Reset Defaults** button. To refresh the screen, click on Refresh. To save the settings, click the **Save** button.

5.4.1.1.3. BLC Mode

This dropdown box allows the user to select Back Light Compensation. The values are Off, BLC (Auto), WDR, and HLC. This feature should only be used in black lit environments. Below is a screenshot of this menu:

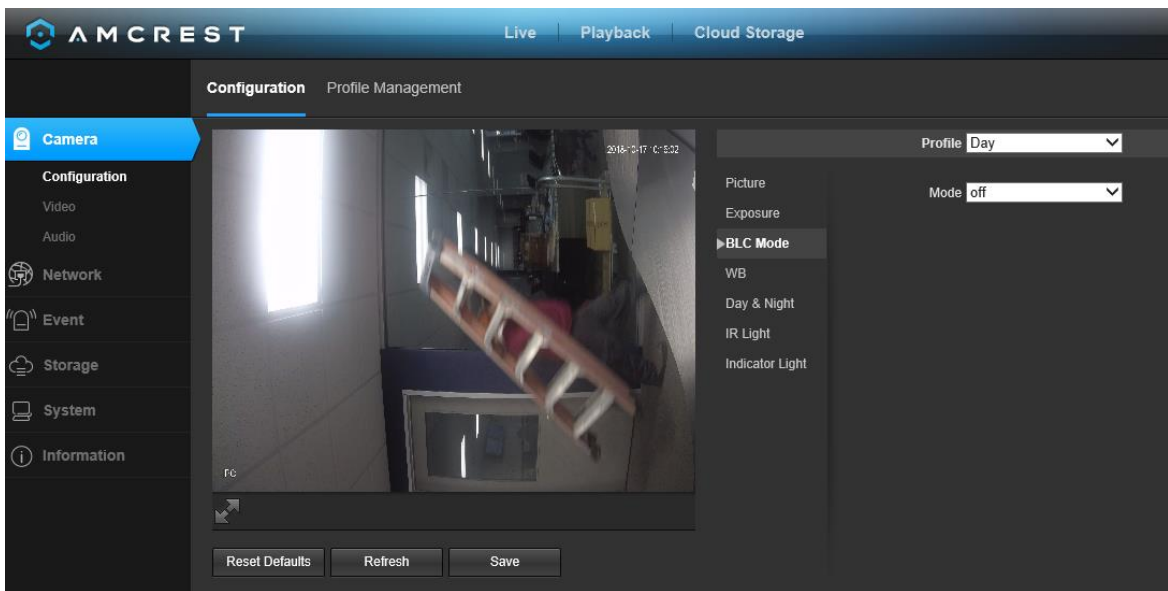

- **BLC:** backlight compensation: Default will use the whole image to balance the lighting settings, and Customized will allow you to balance the lighting settings from the target area.
- **WDR:** Wide Dynamic Range makes multiple scans of a scene to provide one balanced and unwashed image that is clear for the user.
- **HLC:** Highlight compensation is a feature that came out of necessity due to overexposure from strong light sources like headlights or spotlights

To reset to default settings, click the **Reset Defaults** button. To refresh the screen, click on Refresh. To save the settings, click the **Save** button.

5.4.1.1.4. WB

This dropdown box allows the user to select the white balance for the video feed. The different options are Auto, Sunny, Night, Outdoor, and Customized. Selecting customized opens a menu that allows the user to set specific red or blue values. Below is a screenshot of this menu:

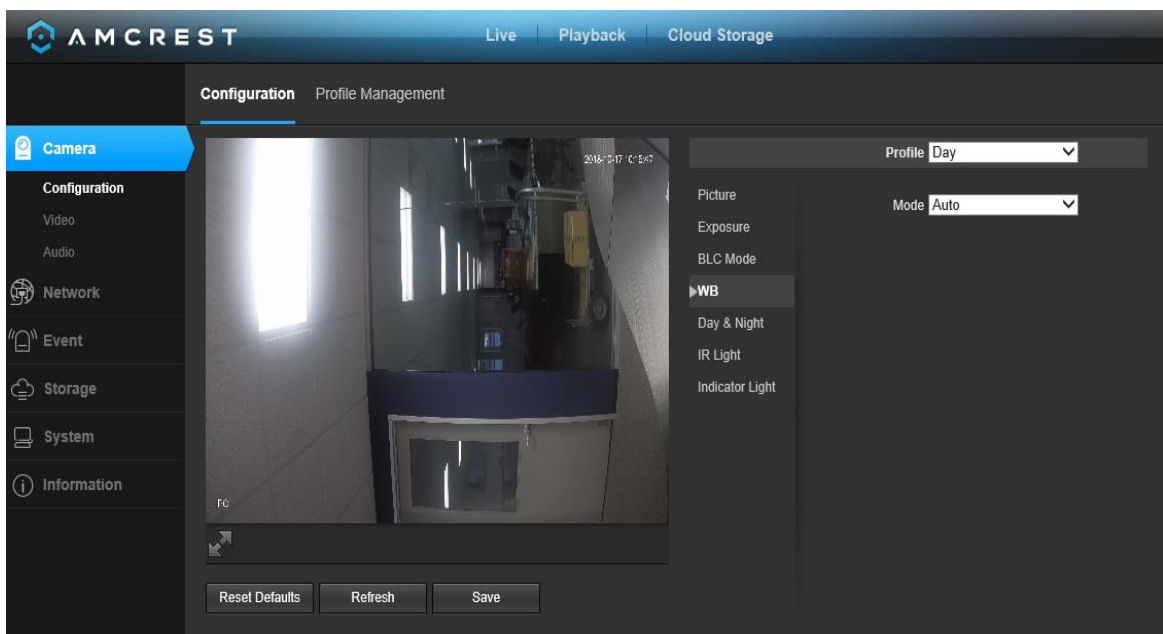

To reset to default settings, click the **Reset Defaults** button. To refresh the screen, click on Refresh. To save the settings, click the **Save** button.

5.4.1.5. Day & Night

Used to determine when black and white mode is turned on in a dark environment. Below is a screenshot of this menu:

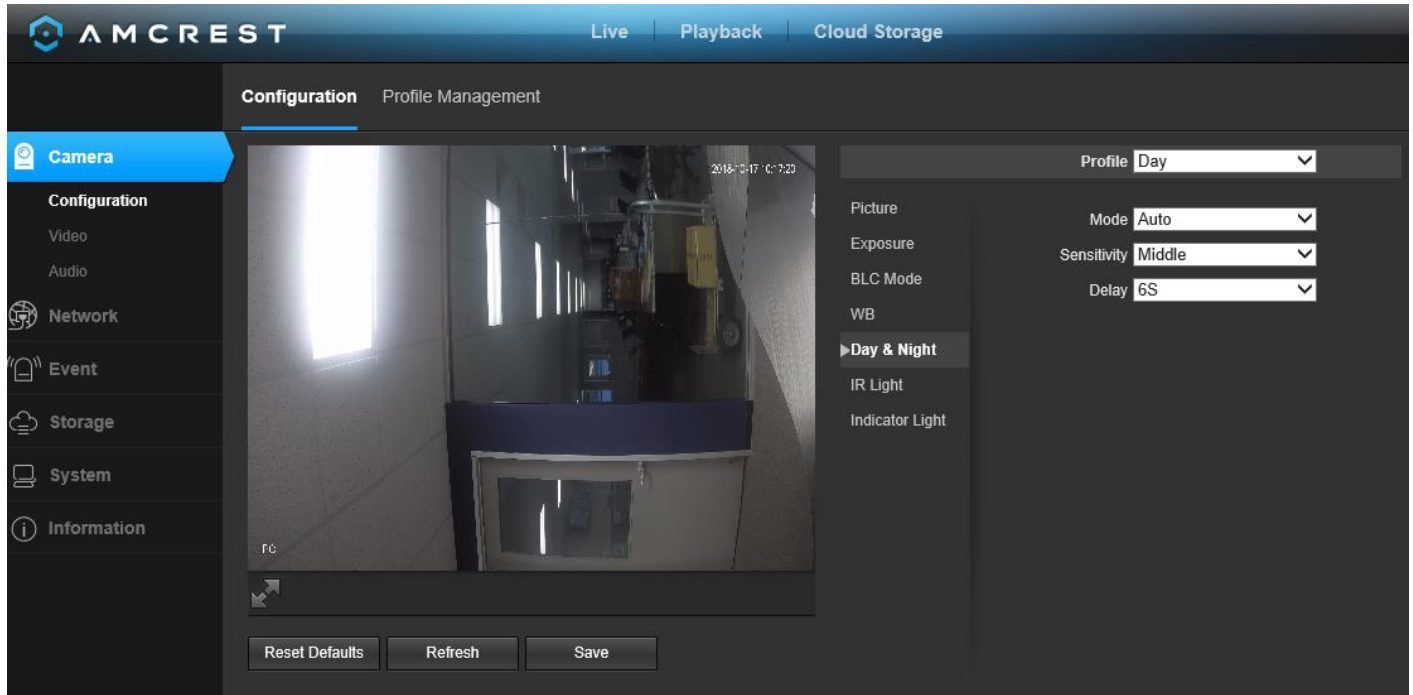

- **Color** - always represents picture in color, does not use IR or black and white mode. Performs poorly in dimly lit areas unless you are using the Starlight series cameras.
- **Auto** - Uses D&N Sensitivity setting to change between color mode and infrared and black and white mode.
- **Black & White** - Always sets picture to black and white, however when illumination is too dark it switches on IR mode.
- **Sensitivity**: This option allows the user to change the Day/Night Sensitivity of the camera. The three options are Low, Middle, and High. The higher the sensitivity, the quicker the camera will change into another mode depending on the light levels.
- **D&N Delay**: This dropdown box allows the user to set a delay in seconds for how long it takes to switch between Day and Night modes. The values range from 2 seconds to 10 seconds.

To reset to default settings, click the **Reset Defaults** button. To refresh the screen, click on Refresh. To save the settings, click the **Save** button.

5.4.1.6. IR Light

This menu allows the user to select whether the IR lights for night vision are on or off for the selected profile. Below is a screenshot of this menu:

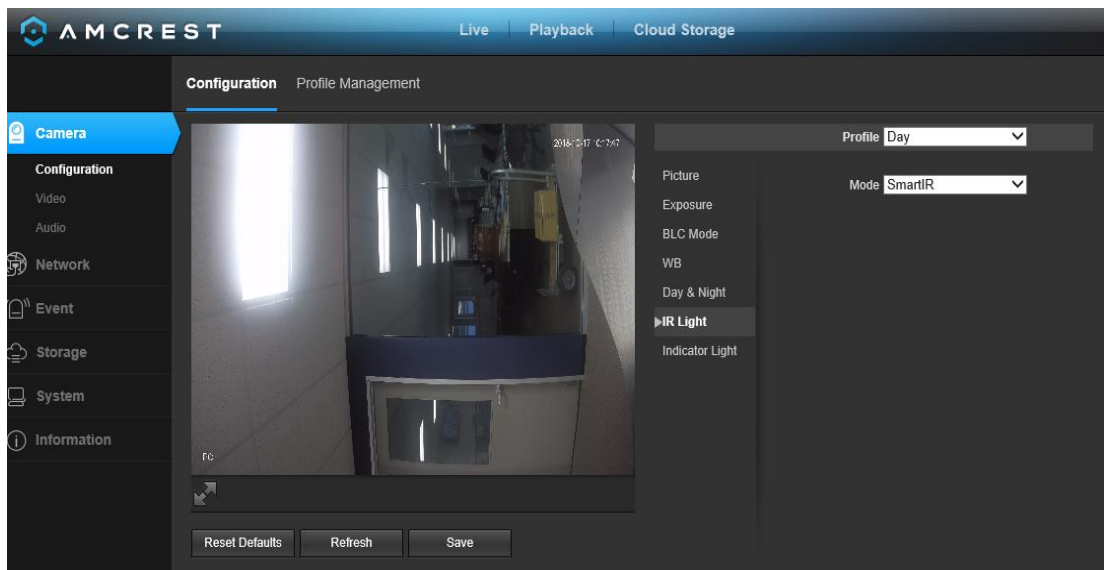

- **Profile:** This dropdown box allows the user to select which profile to modify. The 3 options are Day, Night, and Normal.
- **Mode:** This dropdown box allows the user to select whether to turn the indication light on or off. SmartIR can also be set to automatically set the camera's IR lights to on and off positions based on Day & Night conditions. This setting is usually set by default within the camera.

To reset to default settings, click the **Reset Defaults** button. To refresh the screen, click on Refresh. To save the settings, click the **Save** button.

5.4.1.7. Indicator Light

This menu box allows the user to select whether the indicator light in the camera is on or off for the selected profile. Below is a screenshot of this menu:

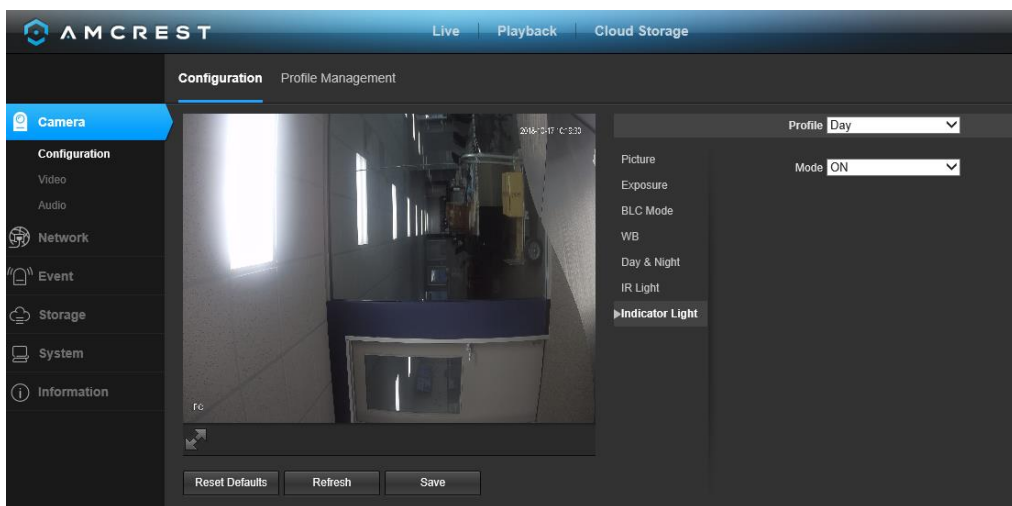

- **Profile:** This dropdown box allows the user to select which profile to modify. The 3 options are Day, Night, and Normal.
 - **Mode:** This dropdown box allows the user to select whether to turn the indication light on or off.
- To reset to default settings, click the **Reset Defaults** button. To refresh the screen, click on Refresh. To save the settings, click the **Save** button.

5.4.1.8. Profile Management

Below is a screenshot that shows the Profile Management tab in the Configuration menu item:

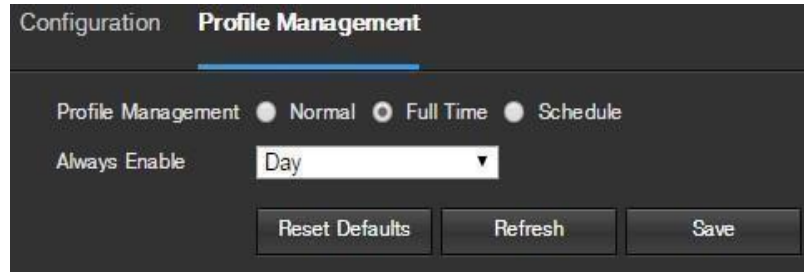

Below is an explanation for each of the fields on the Profile Management tab in the Configuration menu item:

- **Profile Management:** This set of radio buttons allow the user to set what basis the profile management settings run on. There are 3 options: Normal, Full Time, and Schedule. Normal means that the system can automatically alternate between night and day based on the profiles for each. Full Time means that the system sticks to one profile the entire time it is running. Schedule allows the user to dictate which times of the day are designated for the day profile and the night profile.

To reset to default settings, click the Reset Defaults button. To refresh the page, click the Refresh button. To save the settings, click the Save button.

5.4.1.2. Video

This section allows the user to change video settings for the camera's video feed. There are 4 tabs in this menu item: Video, Snapshot, Overlay, and Path.

5.4.1.2.1. Video

Below is a screenshot that shows the Video tab in the Video menu item:

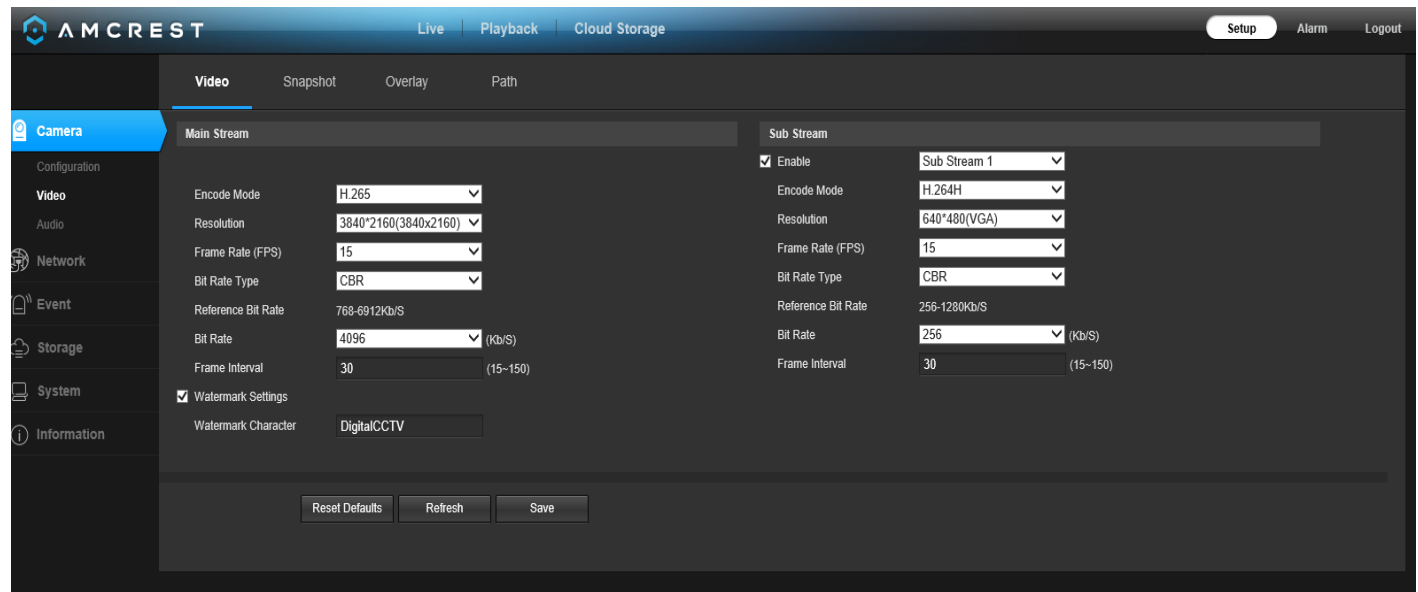

Below is an explanation for each of the fields on the Video tab in the Video menu item:

- **Encode Mode:** This dropdown box allows the user to select a compression protocol. The system supports H.264 and MJPEG video compression protocols.
- **Resolution:** This dropdown box allows the user to set the resolution. The system supports various resolutions and they can be selected from this dropdown list.
- **Frame Rate (FPS):** This dropdown box allows the user to select a frame rate. Frame rate settings are measured in frames per second (FPS) and can range from 1f/s to 25f/s in PAL mode and 1f/s to 30f/s in NTSC mode.
- **Bit Rate Type:** This dropdown box allows the user to select a bit rate type. The system supports two bit rate types: CBR and VBR. In VBR mode, video quality can be set.
- **Reference Bit Rate:** This is the recommended bit rate value according to the resolution and frame rate selected.
- **Bit Rate:** This dropdown box allows the user to select a bit rate.
- **Frame Interval:** This field allows the user to set the P frame amount between two I frames. The value ranges from 1 to 150 seconds. Default value is 50. Recommended value is frame rate *2.
- **Watermark Settings:** This function allows the user to verify if the video has been tampered with.
- **Watermark Character:** This field allows the user to set the watermark's text. The default string is Digital CCTV. The maximum length is 85 characters. This string can only include numbers, characters, and underscores.

Sub Stream is a lower quality stream that allows the feed to take up less resources and bandwidth when streaming. The Main Stream and the Sub Stream have the same fields. Sub Stream can be enabled by checking the box next to Enable.

To reset to default settings, click the Reset Defaults button. To refresh the page, click the Refresh button. To save the settings, click the Save button.

5.4.1.2.2 Snapshot

Below is a screenshot that shows the Snapshot tab in the Video menu item:

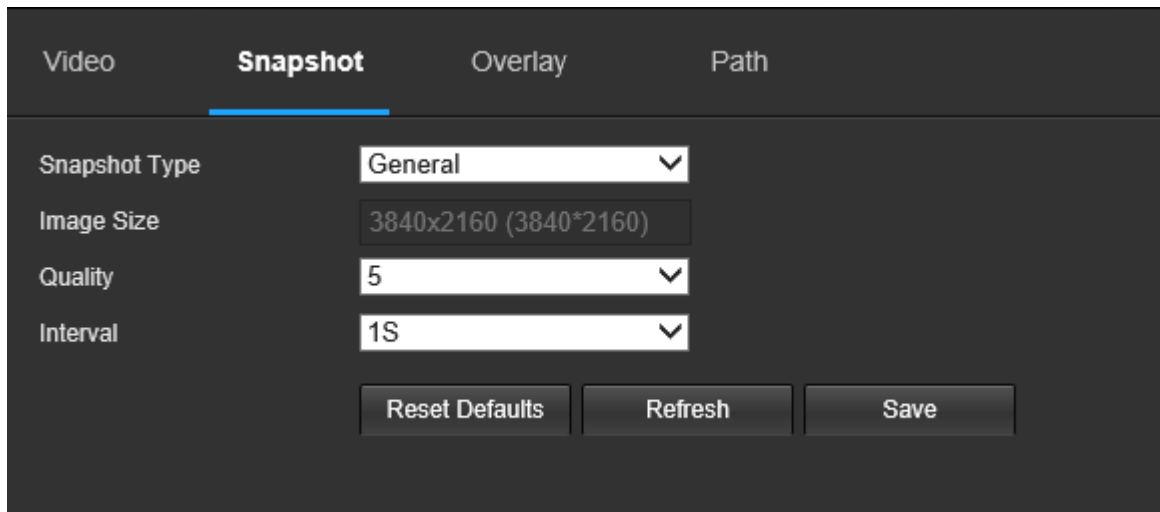

Below is an explanation for each of the fields on the Snapshot tab in the Video menu item:

- **Snapshot Type:** This dropdown box allows the user to select a snapshot mode. There are two snapshot modes:
 - General: Snapshots are taken as scheduled.
 - Event: Snapshots occur when a motion detection alarm or tampering alarm is triggered

- **Image Size:** This dropdown box shows the image size. By default, the screenshot size is the same size as the video feed's resolution.
- **Quality:** This dropdown box allows the user to select image quality. Quality is adjusted on a scale of 1-6.
- **Interval:** This is to set snapshot frequency. The value ranges from 1 to 7 seconds. The maximum setting for a customized interval is 3600s/picture.

To reset to default settings, click the Reset Defaults button. To refresh the page, click the Refresh button. To save the settings, click the **Save** button.

5.4.1.2.3. Overlay

Below is a screenshot that shows the Overlay tab in the Video menu item:

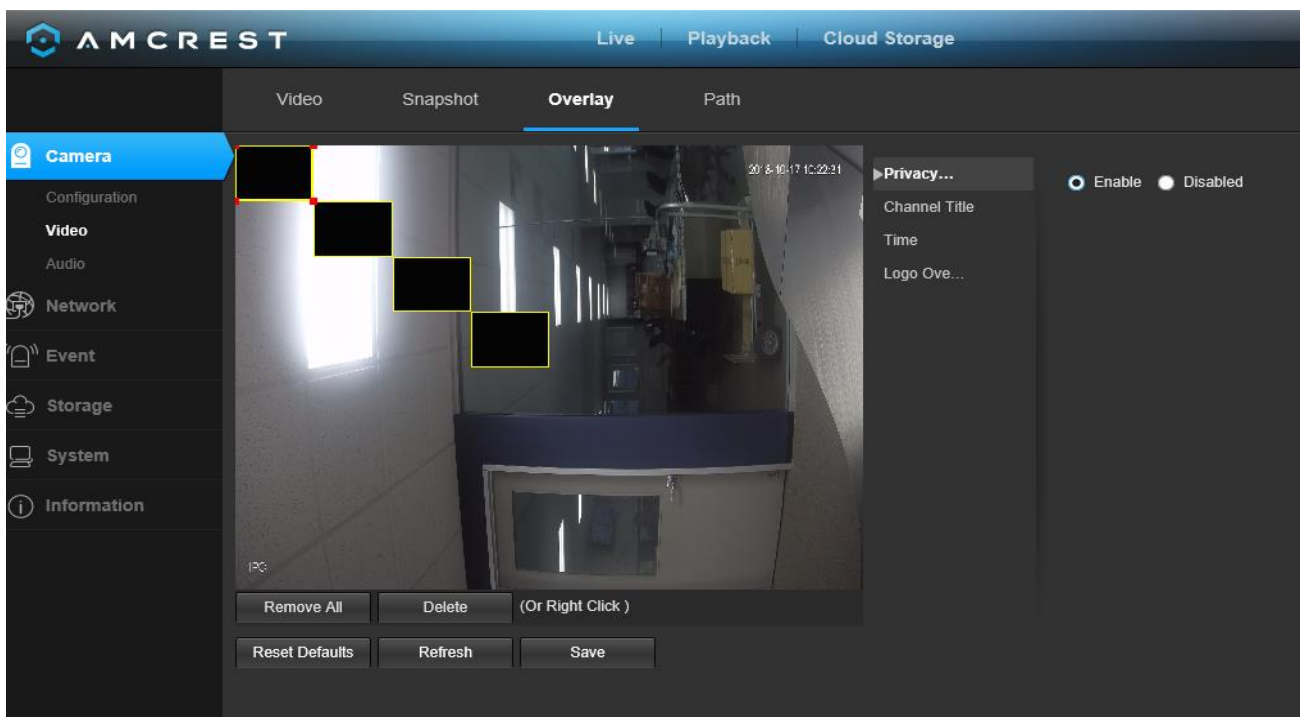

The menu on the left allows the user to select which overlay to modify. Privacy Masking, Channel Title, Time, and Text Overlay can all be modified in this menu.

For **Privacy Masking**, the radio button enables or disables the feature. To set a privacy mask, click one of the boxes in the live view window, and position or resize it as needed. To remove a box, click on it, then click the delete button. To remove all privacy filter boxes, click the remove all button.

For **Channel Title**, the radio button enables or disables the feature. The Input Channel Title field allows the channel title to be modified.

For **Time**, the radio button enables or disables the feature. Clicking the Display Weekdays checkbox will show the weekday at the end of the timestamp.

For **Text Overlay**, the radio button enables or disables the feature. The Input Text box allows the user to enter multiple lines of text as needed, and the Text Alignment dropdown box allows the user to align the text either right or left.

To reset to default settings, click the Reset Defaults button. To refresh the page, click the Refresh button. To save the settings, click the Save button.

5.4.1.2.4 Path

Below is a screenshot that shows the Path tab in the Video menu item:

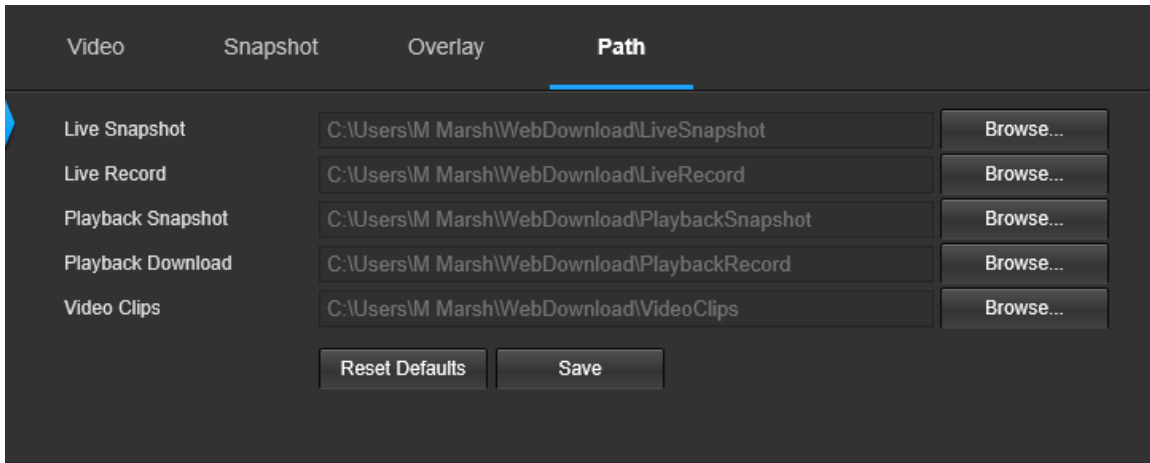

Below is an explanation for each of the fields on the Path tab in the Video menu item:

- The **Live Snapshot** field allows the user to select where to save live snapshots to. Click the Browse button to select a different destination folder.
- The **Live Record** field allows the user to select where to save live recordings to. Click the Browse button to select a different destination folder.
- The **Playback Snapshot** field allows the user to select where to save playback snapshots to. Click the Browse button to select a different destination folder.
- The **Playback Download** field allows the user to select where to save playback video downloads to. Click the Browse button to select a different destination folder.
- The **Video Clips** field allows the user to select where to save video clips to. Click the Browse button to select a different destination folder.

To reset to default settings, click the Reset Defaults button. To save the settings, click the Save button.

5.4.1.3. Audio

This menu allows the user to modify audio settings for the camera. Below is a screenshot that shows the Audio menu item under the Camera menu section:

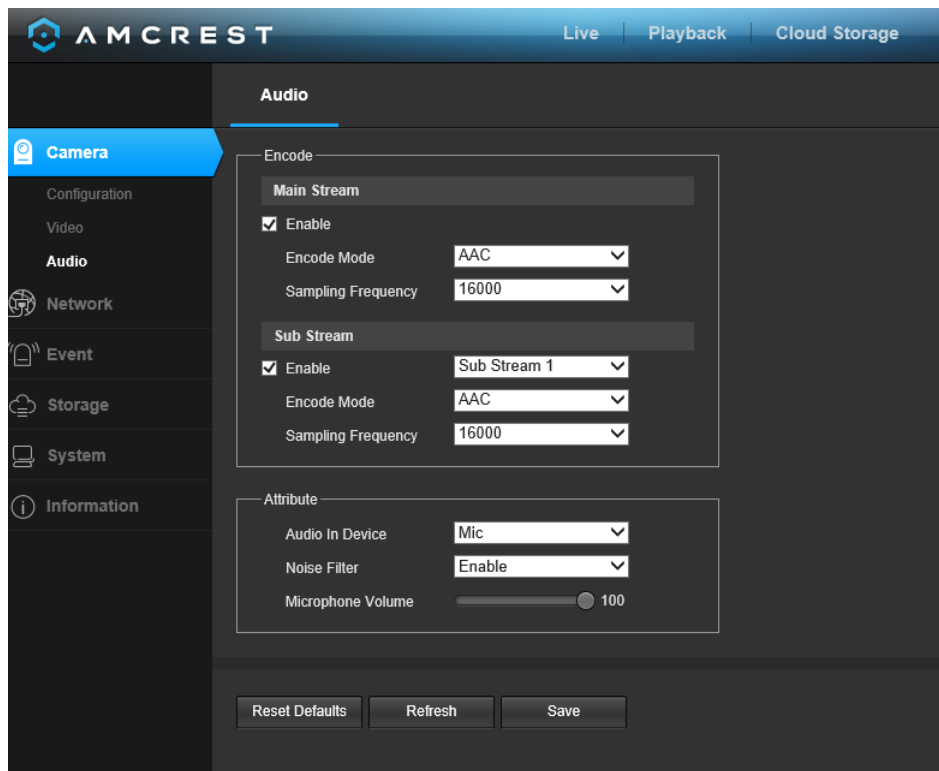

Below is an explanation for each of the fields on the Audio menu:

- **Enable:** This checkbox allows the user to enable audio recording.
- **Encode Mode:** This dropdown box allows the user to select what audio format the audio should be recorded in.
- **Sampling Frequency:** This dropdown box allows the user to select a sampling frequency for the audio. The options are 8k and 16k. 16k audio sampling allows for higher sound quality.
- **Audio in Device:** This field allows the user to select what source to get audio from. The default is the camera's built-in mic. Alternatively, the line in mic can be selected.
- **Noise Filter:** This dropdown box allows the user to enable or disable the audio noise filter function. This function provides cleaner audio quality when enabled.
- **Microphone Volume:** This slider allows the user to select the microphone volume. The value ranges from 0 to 100. The default value is 50.

To reset to default settings, click the Reset Defaults button. To refresh the page, click the Refresh button. To save the settings, click the Save button.

5.4.2 Network

This menu section allows the user to change network settings for the camera.

5.4.2.1 TCP/IP

The TCP/IP menu item has two tabs: TCP/IP and P2P.

5.4.2.1.1 TCP/IP

TCP/IP stands for Transmission Control Protocol/Internet Protocol and it is the language/protocol that allows communication between internet connected devices, whether on a local network, or a on the

Internet at large. This screen allows for TCP/IP settings to be modified for the camera to establish a connection to the network. Below is a screenshot of the TCP/IP settings tab:

Field	Value
Host Name	IPC
Ethernet Card	Wired(DEFAULT) [Set as the Default]
Mode	Static (selected) / DHCP
MAC Address	90 . 02 . a9 . 42 . b4 . 40
IP Version	IPv4
IP Address	192 . 168 . 1 . 148
Subnet Mask	255 . 255 . 255 . 0
Default Gateway	192 . 168 . 1 . 1
Preferred DNS Server	75 . 75 . 76 . 76
Alternate DNS Server	75 . 75 . 75 . 75
Enable ARP/Ping to set IP address service	<input checked="" type="checkbox"/>

Below is an explanation of the fields on the TCP/IP settings tab:

- **Host Name:** This text field allows the user to change the host device name for the camera. This field supports a maximum of 15 characters.
- **Ethernet Card:** This dropdown box allows the user to select which internet access device to use. If the device is connected to a wired connection and a wireless one at the same time, then this box will have options to pick either of the connections. The Set as Default button allows the user to select one of the connection methods as the default one.
- **Mode:** Static vs DHCP: This radio button allows the user to choose between a static IP address, and a dynamic IP address. DHCP stands for Dynamic Host Configuration Protocol, and this enables the camera to automatically obtain an IP address from another network device such as a server or more commonly, a router. When the DHCP function is enabled, the user cannot modify the IP address, Subnet Mask, or Default Gateway, as these values are obtained from the DHCP function. To view the current IP address, DHCP needs to be disabled. Note: When PPPoE is enabled, modification of the IP Address, Subnet Mask, and Gateway becomes prohibited.
- **MAC Address:** This field shows the camera's MAC address, which is unique to this device. This number is read only and is used to access a local area network (LAN).
- **IP Version:** This dropdown allows the user to select the IP version. The two options are IPV4 and IPV6.
- **IP Address:** This field allows the user to enter a custom IP address.
- **Subnet Mask:** This field allows the user to enter a custom subnet mask.
- **Default Gateway:** This field allows the user to enter a custom default gateway.
- **Preferred DNS Server:** This field allows the user to enter the preferred DNS server IP address.
- **Alternate DNS Server:** This field allows the user to enter the alternate DNS server IP address.
- **Enable ARP/Ping to set IP Address Service:** This checkbox allows the user to enable the ARP/Ping service to change the IP address service. For more information on this feature, click the help button while on the TCP/IP settings tab.

To reset to default settings, click the Reset Defaults button. To refresh the page, click the Refresh button. To save the settings, click the Save button.

5.4.2.1.2 P2P

The P2P settings screen is where users can use a QR code to connect their smartphone or tablet to the camera. This feature needs to be enabled for use with the Amcrest View app, Amcrest Cloud, or AmcrestView.com. Below is a screenshot of the P2P settings tab:

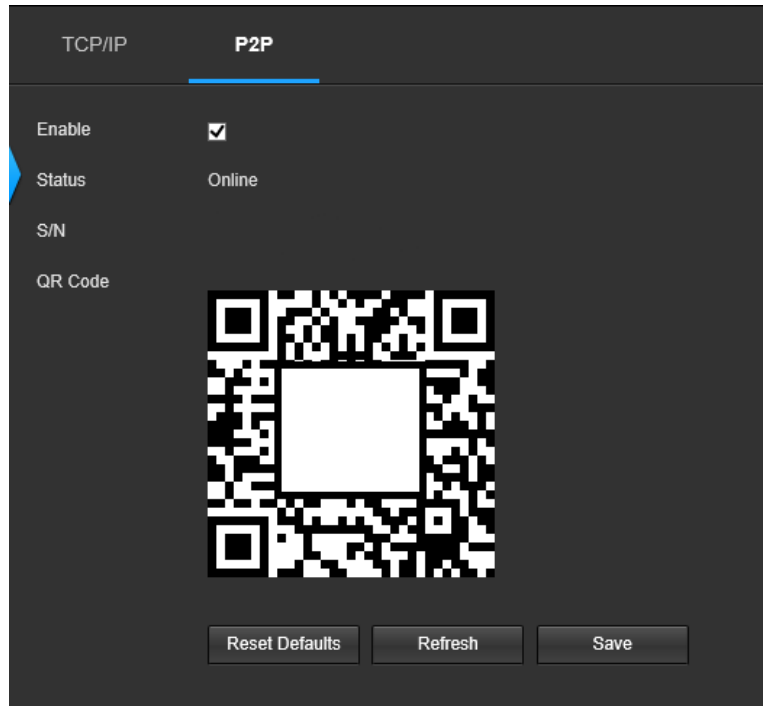

Below is an explanation of the fields on the P2P settings tab:

- Enable:** This checkbox allows the user to enable the P2P feature for the camera. This feature must be enabled for the camera to connect to a smartphone or tablet via the Amcrest View app. It is enabled by default.
- **Status:** This field displays the status of the P2P connection. Once the camera is connected to a device, this field should display the word Online.
- **S/N:** This field displays the Token ID for the camera. The Token ID can be used to manually enter the camera's information on a mobile or tablet device in case the QR code scanning feature cannot be used.
- **QR Code:** This image is a Quick Response (QR) code. By scanning this image using the Amcrest View app, this camera can establish a connection with the app.

To reset to default settings, click the Reset Defaults button. To refresh the page, click the Refresh button. To save the settings, click the Save button.

5.4.2.2. Connection

The Connection menu item has two tabs: Connection and ONVIF.

5.4.2.2.1 Connection

The Connection tab is where users can configure port connections. Below is a screenshot of the Connection settings tab:

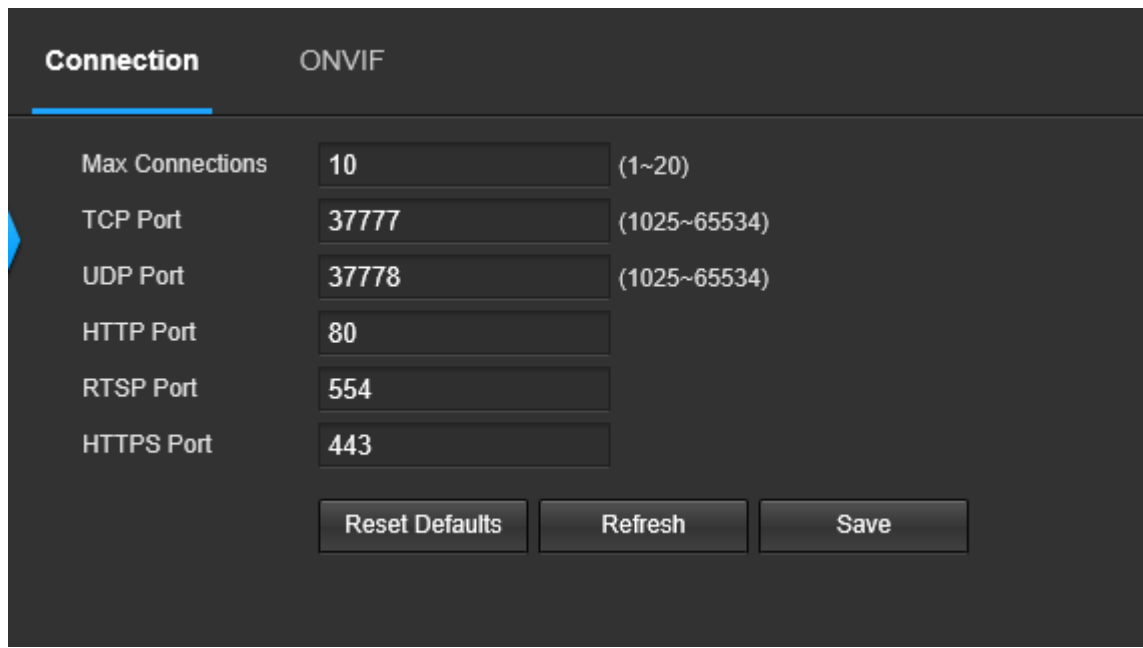

Below is an explanation of the fields on the Connection settings tab:

- **Max Connections:** This field allows the user to specify the maximum number of users that can be connected to the camera at the same time. The maximum number of users the camera can support at one time is 20.
- **TCP Port:** This field designates the Transmission Control Protocol (TCP) port number. The default value is 3777.
- **UDP Port:** This field designates the User Datagram Protocol (UDP) port number. The default value is 3778.
- **HTTP Port:** This field designates the Hypertext Transfer Protocol (HTTP) port number. The default value is 80.
- **RTSP Port:** This field designates the Real Time Streaming Protocol (RTSP) port number. The default value is 554.
- **HTTPS:** This field enables the use of the HTTPS protocol for accessing the camera.
- **HTTPS Port:** This field designates the Hypertext Transfer Protocol Secure (HTTPS) port number. The default value is 443.

To reset to default settings, click the Reset Defaults button. To refresh the page, click the Refresh button. To save the settings, click the Save button.

5.4.2.2.2 ONVIF

The ONVIF tab is where users can configure authentication via the ONVIF standard. Below is a screenshot of the ONVIF settings tab:

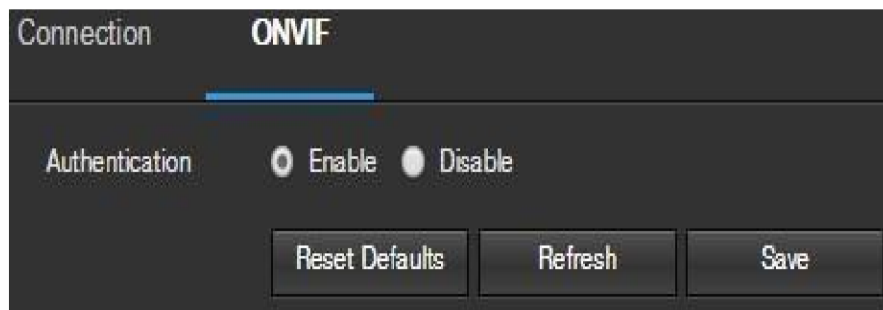

To enable ONVIF, click the radio button next to Enable, and then click the save button.

To reset to default settings, click the Reset Defaults button. To refresh the page, click the Refresh button. To save the settings, click the Save button.

5.4.2.3. DDNS

DDNS stands for Dynamic Domain Name Server. This technology is used to automatically update name servers in real time to help the camera maintain a persistent address despite changes in location or configuration. What this means is that even when the camera is restarted, moved, or reconfigured, it can keep the same IP address, thus allowing remote users uninterrupted access to the camera, rather than having to request a new IP address to use for remote access anytime a change is made.

To use this feature, users will need to setup an account with a DDNS service. The camera supports a variety of DDNS services such as Quick DDNS, NO-IP DDNS, CN99 DDNS, and DynDNS DDNS. Based on which service is selected, different options may show on this screen. For purposes of this guide, AmcrestDDNS will be used. AmcrestDDNS is a free DDNS service provided by Amcrest, and it must be renewed every year. A renewal reminder email will be sent to the email entered in the username field below.

Below is a screenshot of the DDNS settings screen, configured to AmcrestDDNS:

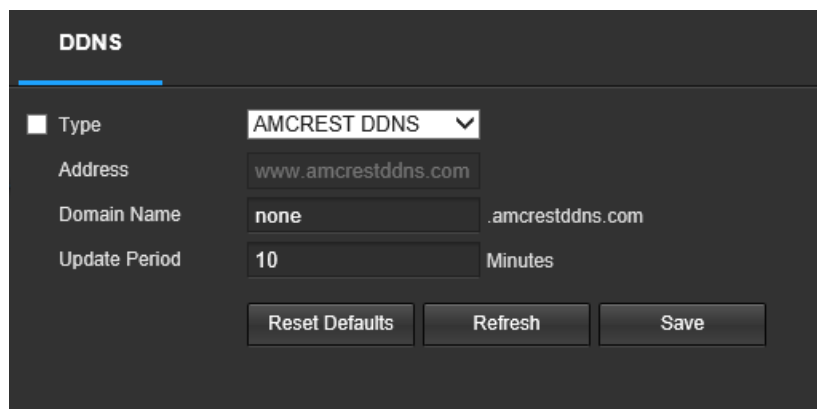

To reset to default settings, click the Reset Defaults button. To refresh the page, click the Refresh button. To save the settings, click the Save button.

5.4.2.4 IP Filter

This screen allows for the filtering of IP addresses, either blocking them, or granting them access to the camera. This feature helps make the camera more secure by limiting remote access only to approved users. Below is a screenshot of the IP Filter screen:

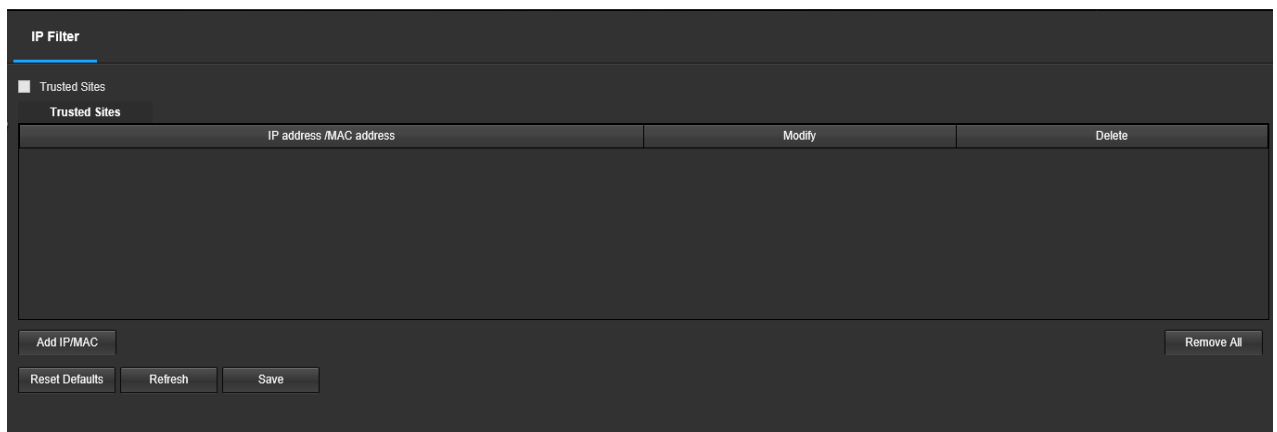

Below is an explanation of fields on the IP Filter settings screen:

- **Trusted Sites:** This checkbox allows the user to enable the IP Filter feature for trusted sites.
- **Add IP/MAC:** This button opens a popup that allows the user to add IP or MAC addresses to the trusted site list. Note: When accessing the camera externally, please add the MAC address of the router on the PC end.
- **Remove All:** This button allows the user to remove all sites from the trusted IP/MAC list.

To reset to default settings, click the Reset Defaults button. To refresh the page, click the Refresh button. To save the settings, click the Save button.

5.4.2.5. SMTP (Email)

This screen allows for the configuring of email settings to permit the camera to send emails when an alarm is triggered. Below is a screenshot of the email settings screen:

Below is an explanation of fields on the SMTP (Email) settings screen:

- **SMTP Server:** SMTP stands for Simple Mail Transfer Protocol. This field allows the user to enter the SMTP server used by the email service.
- **Port:** This field allows the user to enter the port that corresponds to the selected SMTP server.
- **Login Anonymously:** This checkbox allows the user to anonymously login to the server.

- **Username:** This field allows the user to enter the SMTP username.
 - **Password:** This field allows the user to enter the password associated with the SMTP username.
 - **Sender:** This field allows the user to enter the sender email address. This email address will be the one that sends out all emails pertaining to the alerts and alarm emails sent by the camera.
 - **Authentication:** This dropdown box allows the user to select an encryption type. There are two types of email encryption protocols that are available.
 - **SSL:** Secure Socket Layer
 - **TLS:** Transport Layer Security
 - **Subject:** This field allows the user to define the subject line of the email that is sent to the receivers.
 - **Recipients:** This field allows the user to enter the receiver email address. These email addresses are the ones that will receive any emails pertaining to alert and alarm emails sent by the camera. Up to 3 email addresses can be entered in this field.
- Interval:** This field allows the user to define, in seconds, how long the system should wait between sending emails. This prevents multiple emails from being sent out.
- **Keep Alive:** This checkbox allows the user to enable a function to periodically check in with the SMTP server to ensure it can connect correctly.
 - **Email Test:** This button causes the system to automatically send out an email to test the connection is OK or not. Prior to the email test, please save the email setup information.

To reset to default settings, click the Reset Defaults button. To refresh the page, click the Refresh button. To save the settings, click the Save button.

5.4.2.6. UPnP

UPnP stands for Universal Plug and Play, and it is a protocol used to easily connect devices to the internet. In the case of this camera, it allows the camera to connect to the router in an easy manner to quickly allow for remote access. Below is a screenshot of the UPnP settings screen:

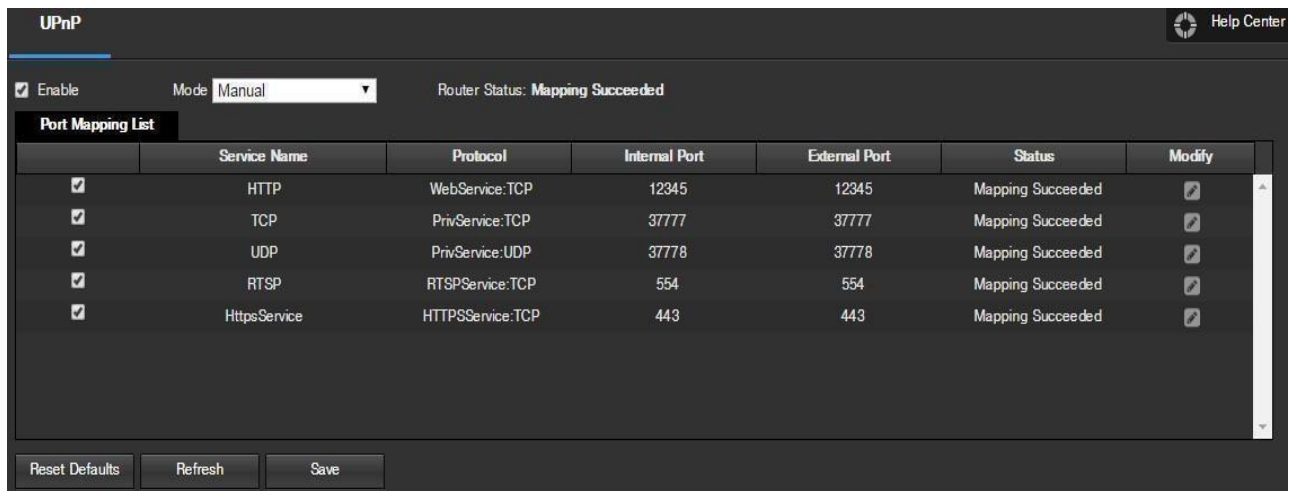

Below is an explanation of fields on the UPnP settings screen:

- **Enable:** This checkbox allows the user to enable the UPnP function.
- **Router State:** This field shows the UPnP status and has two options: **Unknown:** This means that UPnP mapping has failed. **Successful:** This means that UPnP mapping has succeeded.

- **Port Mapping List:** This table is used to show how the ports for each protocol listed below have been remapped by the UPnP protocol.
 - The first column shows the checkboxes to enable the corresponding service on the table.
 - The second column shows the name of the services. To edit this, double click on the service line item.
 - The third column shows the name of the protocol used by that service. To edit this, click the pencil button in the modify column for that line item.
 - The fourth column shows the Internal Port used by that service to establish communication from the router to the camera. To edit this, click the pencil button in the modify column for that line item.
 - The fifth column shows the External Port used by that service to establish communication from the router to the internet. To edit this, click the pencil button in the modify column for that line item.
 - The sixth column shows the status of the protocol. If the protocol was mapped successfully, this field will say “Mapping Succeeded”.
 - The seventh column allows the user to open a dialog box and edit the service’s information.

To reset to default settings, click the Reset Defaults button. To refresh the page, click the Refresh button. To save the settings, click the Save button.

5.4.2.7. SNMP

SNMP stands for Simple Network Management Protocol. This protocol is used to provide a basic framework to allow connection between various network devices. Below is a screenshot of the SNMP settings screen:

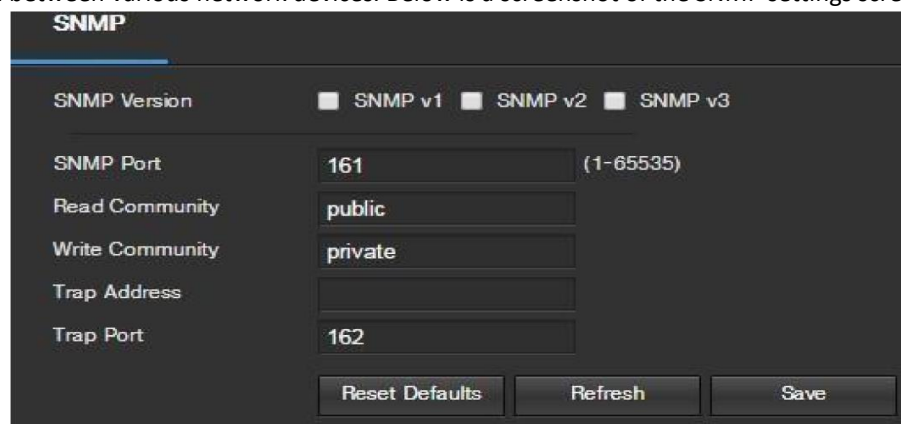

Below is an explanation of fields on the SNMP settings screen:

- **SNMP Version:** These checkboxes allow the user to select the SNMP version to use.
- **SNMP Port:** This field allows the user to write in a port for SNMP to use. The port can range from anywhere from 1 to 65535.
- **Read Community:** This field shows which SNMP community has read access.
- **Write Community:** This field shows which SNMP community has write access.
- **Trap Address:** This field allows the user to write in a trap address.
- **Trap Port:** This field allows the user to write in a trap port number. The trap port number should not be the same as the SNMP port.

To reset to default settings, click the Reset Defaults button. To refresh the page, click the Refresh button. To save the settings, click the Save button.

5.4.2.8. Bonjour

Bonjour is Apple's implementation of Zero-configuration networking (Zeroconf), a group of technologies that includes service discovery, address assignment, and hostname resolution. Below is a screenshot of the Bonjour settings screen:

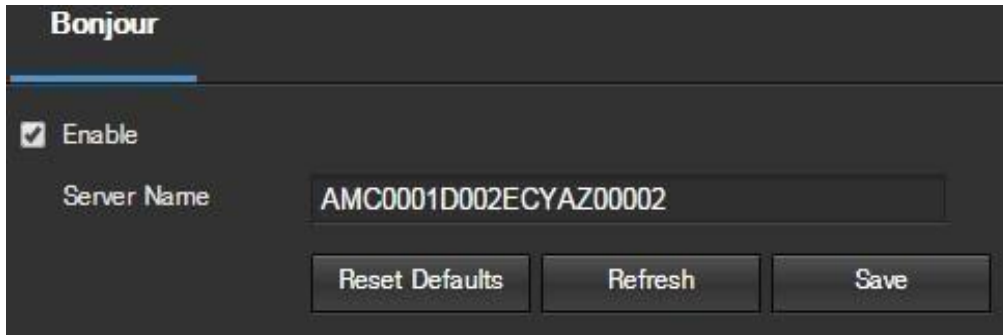

Click the checkbox next to Enable to the Bonjour functionality. The Server Name field allows the user to specify what name to use to connect devices via the Bonjour protocol.

To reset to default settings, click the Reset Defaults button. To refresh the page, click the Refresh button. To save the settings, click the Save button.

5.4.2.9. Multicast

Multicast is a feature that enables the camera to broadcast its live view to multiple computers on the same network. Below is a screenshot of the multicast screen:

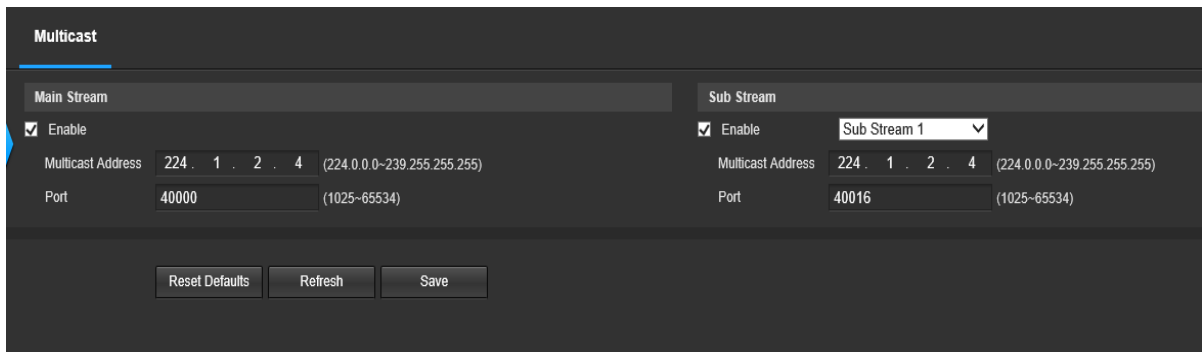

Below is an explanation of the fields in the Multicast settings screen:

- **Enable:** This checkbox allows the user to enable Multicast functionality.
- **Multicast Address:** This field allows the user to enter a multicast address.
- **Port:** This field allows the user to enter a multicast port.

To reset to default settings, click the Reset Defaults button. To refresh the page, click the Refresh button. To save the settings, click the Save button.

5.4.2.10. WiFi

The WiFi feature on this camera allows it to connect to a network wirelessly. Below is a screenshot of the WiFi tab on the WiFi menu:

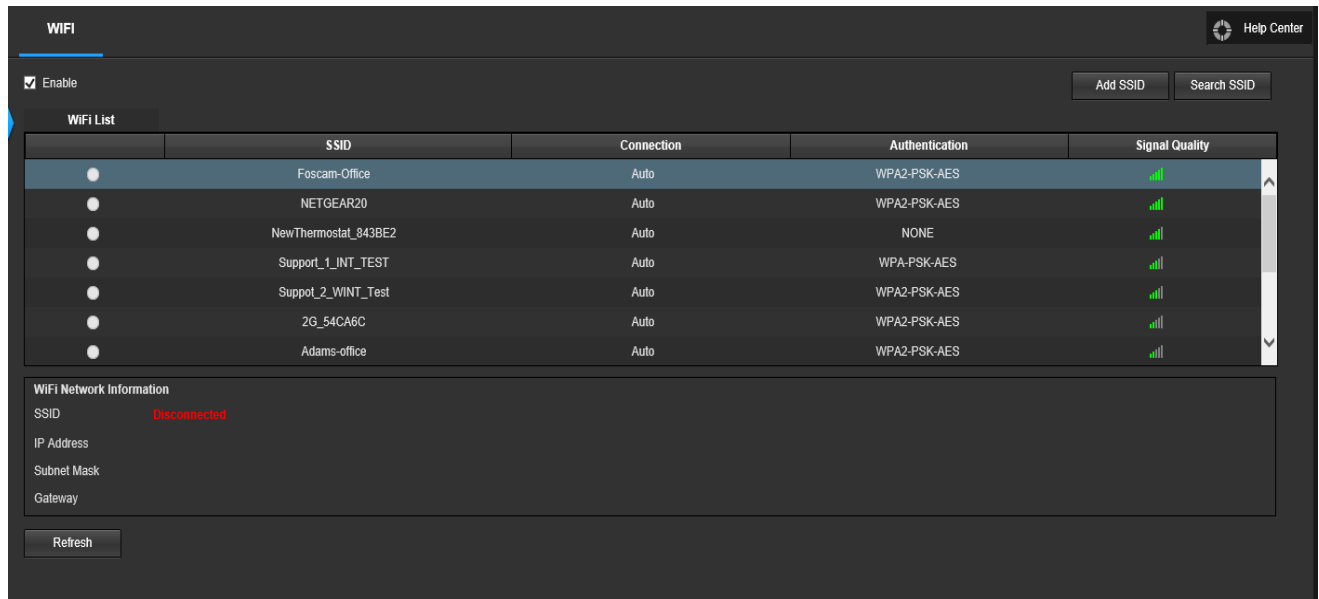

Below is an explanation of the fields on the WiFi tab of the WiFi menu:

- **Enable:** This checkbox allows the user to enable WiFi functionality.
- **Add SSID:** This button allows the user to manually enter in an SSID.
- **Search SSID:** This button allows the user to search for more SSIDs.
- **Refresh:** This button obtains the most recent WiFi network information.

To connect to a WiFi network, click the line item for your WiFi network and enter the WiFi password. Click on **Connect** to connect the camera to your WiFi network.

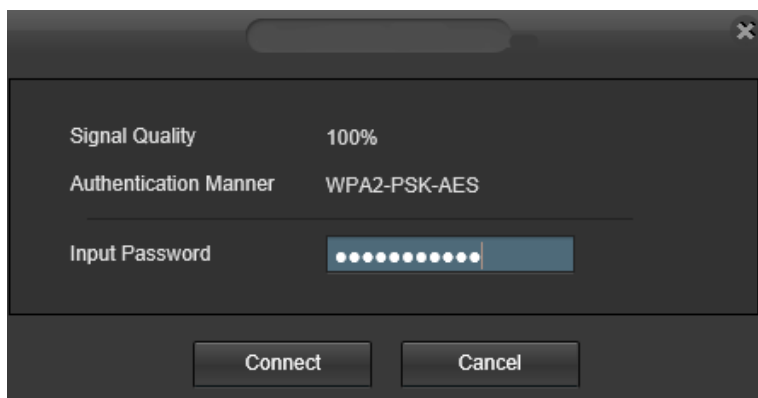

Allow the device to connect to your WiFi network. Once complete, the SSID field will show a green **Connected** prompt:

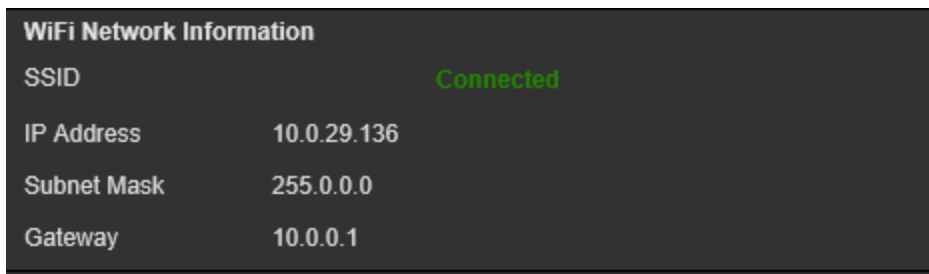

The WiFi camera will now be connected to your WiFi network. You can now remove the Ethernet cable from the device. Please note, the IP address listed in the **WiFi Network Information** menu will be the IP address used to access your camera wirelessly.

5.4.2.11. 802.1x

802.1x is an authentication method for connecting to a network. Below is a screenshot of the 802.1x screen :

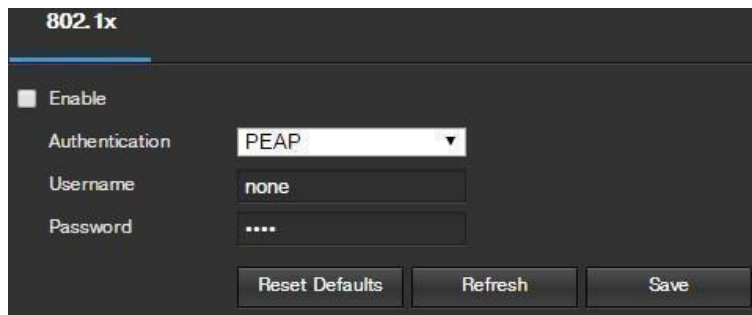

To enable 802.1x, click the checkbox next to Enable. An authentication method can be chosen from the dropdown box, and a username and password can be entered in their respective fields.

To reset to default settings, click the Reset Defaults button. To refresh the page, click the Refresh button. To save the settings, click the Save button.

5.4.2.12. QoS

QoS stands for Quality of Service and it refers to the overall performance of a computer network, particularly the performance seen by the users of the network. Below is a screenshot of the QoS screen:



Below is an explanation of the fields on the QoS screen:

- **Realtime Monitor:** This field allows the user to enter in a priority value for real time monitoring packets. The range is between 0-63.

- **Command:** This field allows the user to enter in a priority value for command packets. The range is between 0-63.

To reset to default settings, click the Reset Defaults button. To refresh the page, click the Refresh button. To save the settings, click the Save button.

5.4.2.10. HTTPS

This menu allows the user to enable and create HTTPS certificates. Below is a screenshot of this menu:

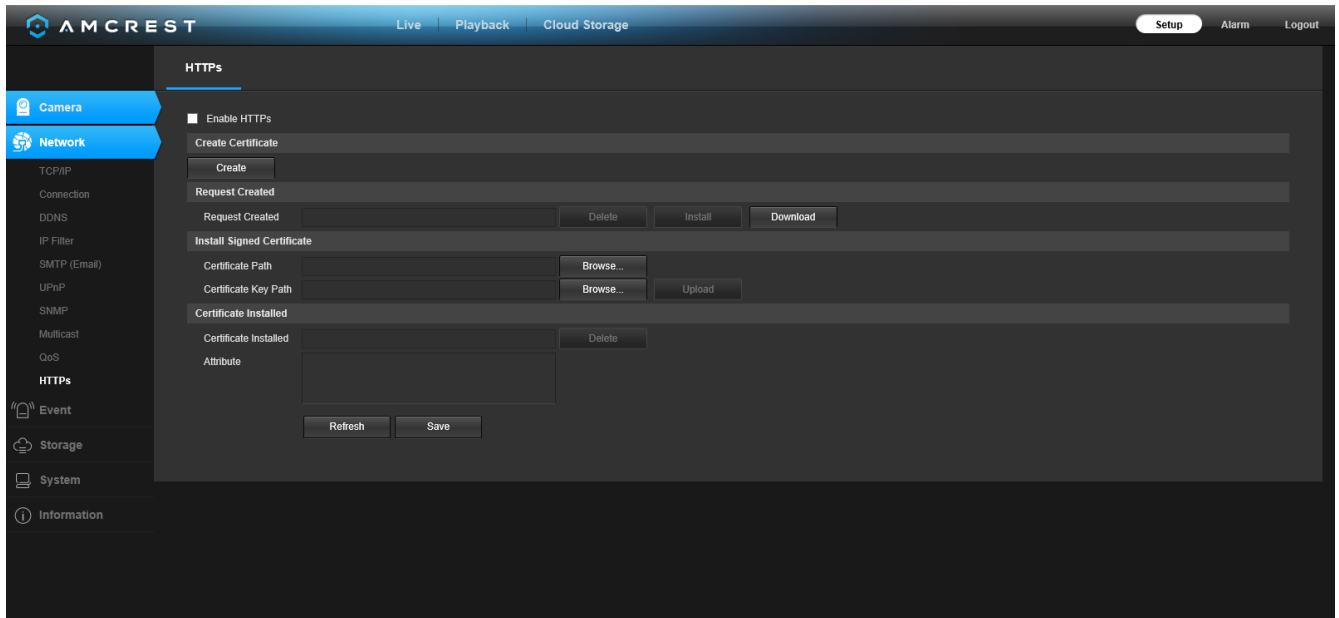

Before you create certificate or download certificate, from main window->Setup->Network >Connection, set the HTTPS port values and then check the box to enable HTTPS

For more information on how to setup HTTPS in the web user interface visit

<https://www.youtube.com/watch?v=gkjlaf-luso>

5.4.3 Event

This menu section allows the user to change different settings for triggering events.

5.4.3.1 Video Detection

The video detection menu has two tabs: Motion Detect and Video Tamper.

5.4.3.1.1 Motion Detect

This tab allows the user to modify motion detection settings. Below is a screenshot of the Motion Detect tab:

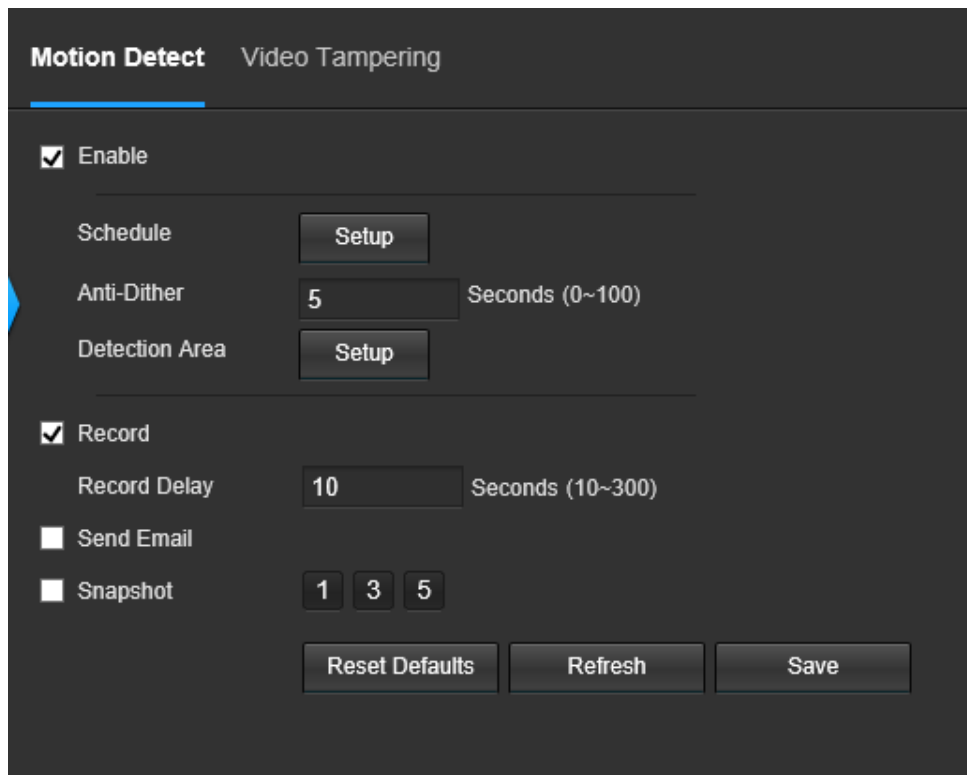

Below is an explanation of the fields on the Motion Detect tab:

- **Enable:** This checkbox enables motion detection for the camera.
- **Schedule:** Clicking this button opens a weekly schedule that can be used to set times.

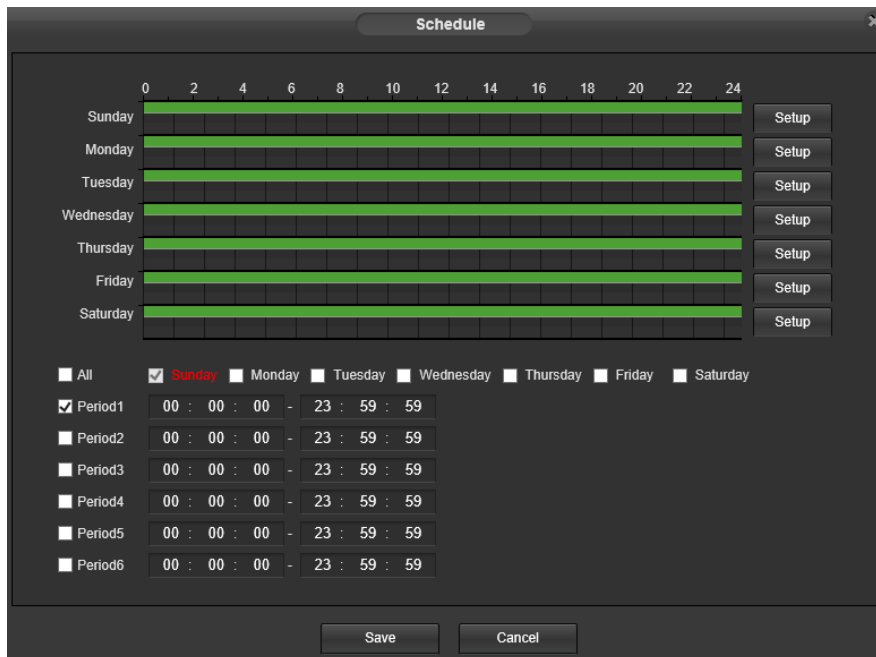

- Click and drag to set motion detection for certain days of the week. Also, periods of motion detection can be set for each day and enabled using the period settings on the bottom half of the screen. There are a total of 6 periods that can be set.

Anti-Dither: This field allows the user to set the anti-dither time. The values in this field can range from 5 to 600 seconds. This time value controls how long the alarm signal lasts. Based on motion detection, a buzzer can go off, a tour can begin, a snapshot can be taken, or the camera can begin recording.

- For example, if the anti-dither time is set to 10 seconds, each alarm may last 10 seconds if the local alarm is activated. During the process, if the system detects another local alarm signal at the fifth second, the buzzer, tour, snapshot, record channel functions will begin another 10 seconds while the screen prompt, alarm upload, email will not be activated again. After 10 seconds, if system detects another alarm signal, it can generate a new alarm since the anti-dither time has expired.
- **Detection Area:** Clicking this button opens a pop-up screen that can be used to set detection areas.

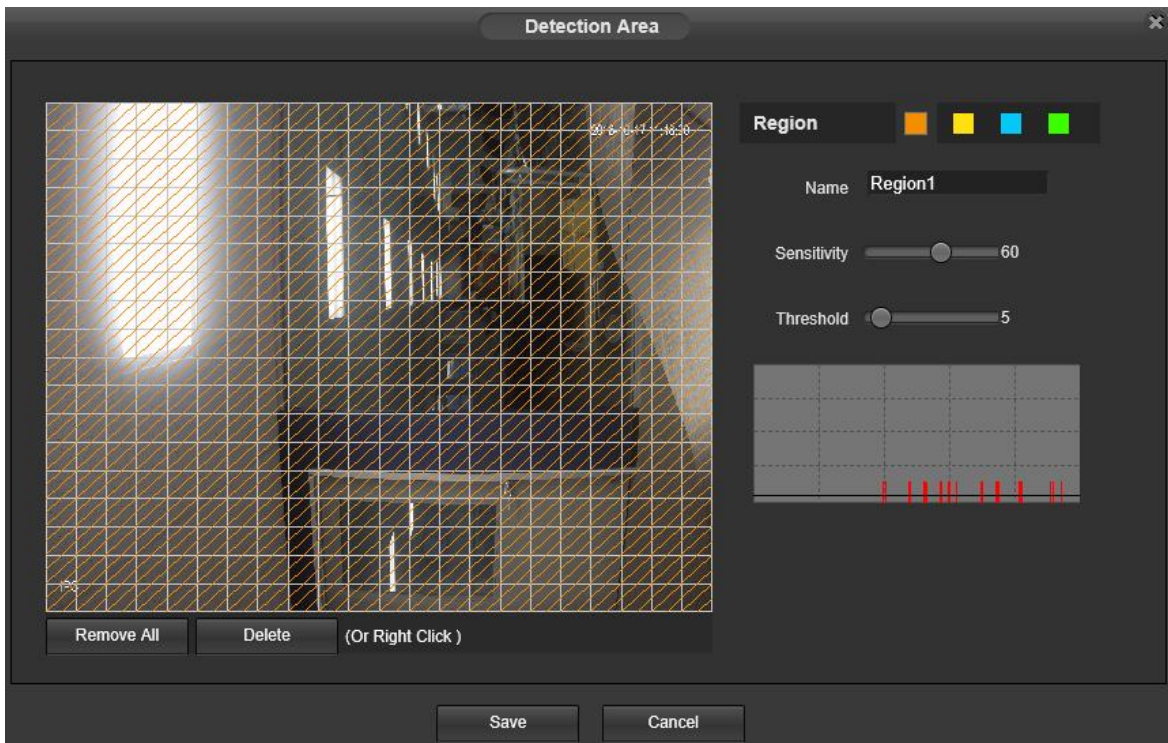

- When the setup button is clicked, a live stream of the video is shown. The user can then set up to 4 regions, each with their own region name, sensitivity (1-100), and threshold (1-100). Each region has a specific color, and the region selector tool is displayed when the mouse is moved to the top of the screen.
 - ✦ Sensitivity is the amount of change required to increase the motion detected by a percentage. The lower the sensitivity, the more movement is required to trigger an alarm.
 - ✦ Threshold is the level that the motion detection needs to reach to trigger an alarm. The lower the threshold, the more likely that motion will trigger an alarm.
 - ✦ To designate a zone, click and drag the mouse over the area desired. When a colored box is displayed over the live feed, that area is now enabled for motion detection.

After the motion detection zone is set, click the enter button to exit the motion detection screen.

Remember to click the save button on the motion detection settings screen, otherwise the motion detection zones will not go into effect. Clicking the cancel button to leave the motion detection zone and will not save the zone setup.

- **Record:** This checkbox allows the user to enable the camera to record video when a motion detection alarm is triggered.
- **Record Delay:** This field specifies in seconds how long the delay between alarm activation and recording should be.
- **Relay Out:** This checkbox allows the user to enable the camera to trigger a connected alarm (connected to the alarm port on the back of the camera) when a motion detection alarm is triggered.

- **Alarm Delay:** This field specifies in seconds how long the delay between alarm activation and Relay alarm activation should be.
- **Send Email:** This checkbox allows the user to enable the camera to send an email when a motion detection alarm is triggered.
- **Snapshot:** This checkbox allows the user to enable the camera to take a snapshot when a motion detection alarm is triggered.

To reset to default settings, click the Reset Defaults button. To refresh the page, click the Refresh button. To save the settings, click the Save button.

5.4.3.1.2 Video Tampering

This tab allows the user to modify video tamper settings. Below is a screenshot of the Video Tamper tab:

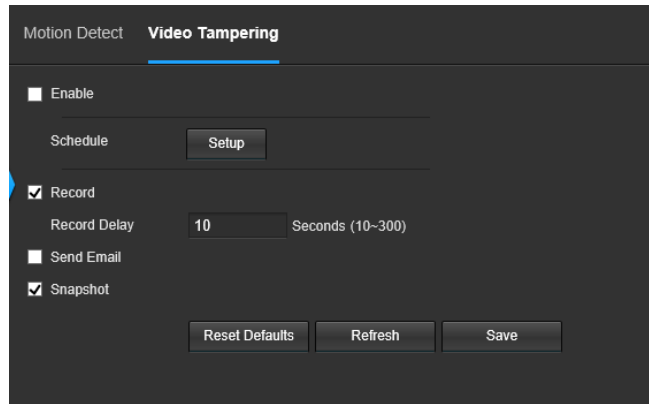

Below is an explanation of the fields on the Video Tamper tab:

- **Enable:** This checkbox enables a video tamper alarm for the camera.
- **Schedule:** Clicking this button opens a weekly schedule that can be used to set times.

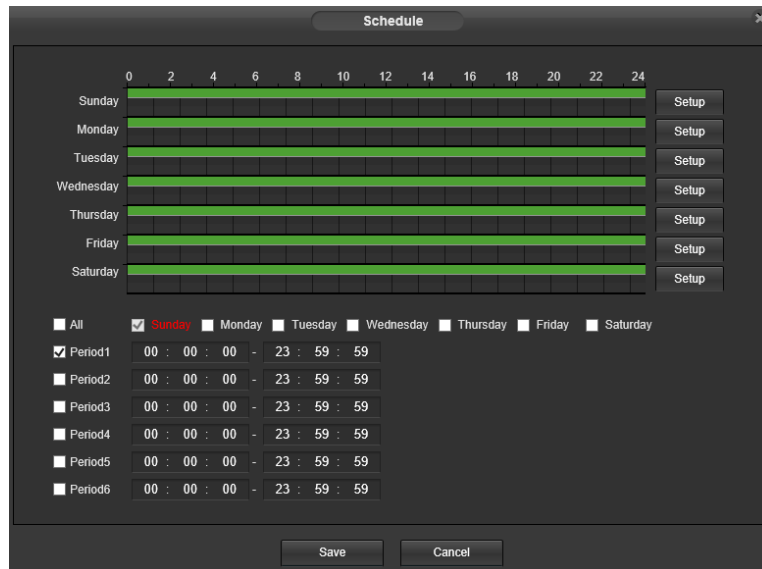

- Click and drag to set video tampering for certain days of the week. Also, periods of video tampering can be set for each day and enabled using the period settings on the bottom half of the screen. There are a total of 6 periods that can be set.
- **Record:** This checkbox allows the user to enable the camera to record video when a video tampering alarm is triggered.
- **Record Delay:** This field specifies in seconds how long the delay between alarm activation and recording should be.
- **Relay Out:** This checkbox allows the user to enable the camera to trigger a connected alarm (connected to the alarm port on the back of the camera) when a video tamper alarm is triggered.
- **Alarm Delay:** This field specifies in seconds how long the delay between alarm activation and Relay alarm activation should be.
- **Send Email:** This checkbox allows the user to enable the camera to send an email when a video tampering alarm is triggered.
- **Snapshot:** This checkbox allows the user to enable the camera to take a snapshot when a video tampering alarm is triggered.

To reset to default settings, click the Reset Defaults button. To refresh the page, click the Refresh button. To save the settings, click the Save button.

5.4.3.2. Audio Detection

This menu allows the user to modify audio detection settings. Below is a screenshot of the Audio Detect screen: Below is an explanation of the fields on the Audio Detect tab:

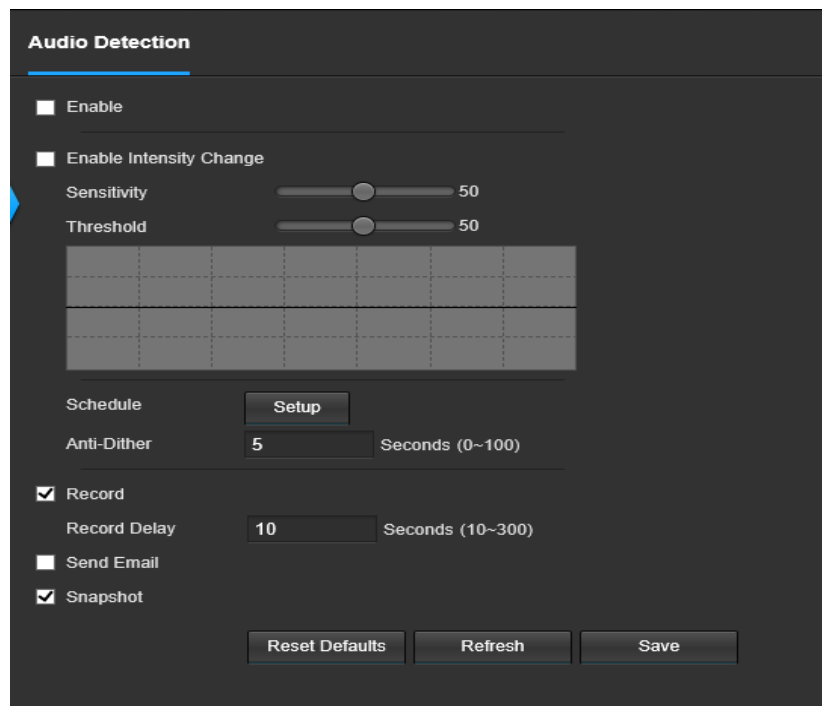

- **Enable:** This checkbox enables an audio detection alarm for the camera.
- **Enable Intensity Change:** This checkbox enables intensity change for the camera audio.
 - Sensitivity is the amount of change required to increase the audio detected by a percentage. The lower the sensitivity, the more audio variance is required to trigger an alarm.
- **Enable Intensity Change:** This checkbox enables the user to adjust sensitivity and threshold settings for audio detection.

- o **Sensitivity:** The higher the sensitivity, the more likely that audio will trigger an alarm.
- o **Threshold:** The lower the threshold, the more likely that audio will trigger an alarm.
- **Schedule:** Clicking this button opens a weekly schedule that can be used to set times.

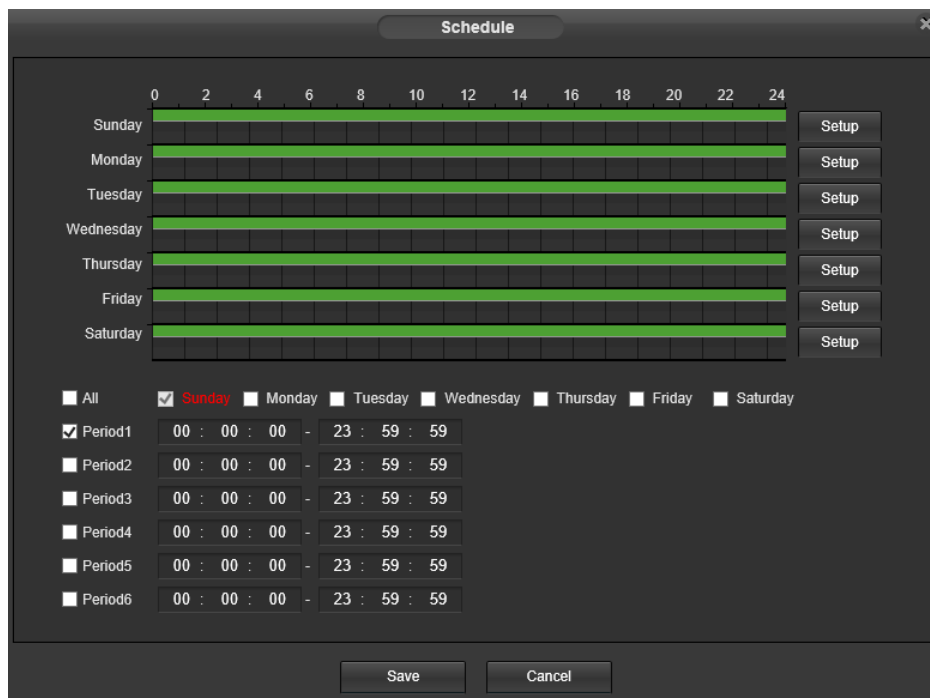

o Click and drag to set audio tampering for certain days of the week. Also, periods of audio detection can be set for each day and enabled using the period settings on the bottom half of the screen. There are a total of 6 periods that can be set. 93.

- **Anti-Dither:** This field allows the user to set the anti-dither time. The values in this field can range from 5 to 600 seconds. This time value controls how long the alarm signal lasts. Based on audio detection, a buzzer can go off, a tour can begin, PTZ can be activated, a snapshot can be taken, or the camera can begin recording.

o For example, if the anti-dither time is set to 10 seconds, each alarm may last 10 seconds if the local alarm is activated. During the process, if the system detects another local alarm signal at the fifth second, the buzzer, tour, PTZ activation, snapshot, record channel functions will begin another 10 seconds while the screen prompt, alarm upload, email will not be activated again. After 10 seconds, if system detects another alarm signal, it can generate a new alarm since the anti-dither time has expired.

- **Record:** This checkbox allows the user to enable the camera to record video when an audio detection alarm is triggered.
- **Record Delay:** his field specifies in seconds how long the delay between alarm activation and recording should be.
- **Send Email:** This checkbox allows the user to enable the camera to send an email when an audio detection alarm is triggered.
- **Snapshot:** This checkbox allows the user to enable the camera to take a snapshot when an audio detection alarm is triggered.

To reset to default settings, click the Reset Defaults button. To refresh the page, click the Refresh button. To save the settings, click the Save button.

5.4.3.3 Abnormality

This menu allows the user to adjust abnormality event settings. This menu has 3 tabs: SD Card, Network, and Illegal Access.

5.4.3.3.1 SD Card

This tab allows the user to set the camera's response to an SD card related abnormality. Below is a screenshot of the SD card tab screen:



Below is an explanation of the fields on the SD Card settings tab:

- **Event Type:** This dropdown box allows the user to select which SD card abnormality to set event triggers for. The 3 options are No SD Card, SD Card Error, and Capacity Warning.
- **Enable:** This checkbox enables the SD Card abnormality trigger for the camera.
- **Relay Out:** This checkbox allows the user to enable the camera to trigger an alarm when an SD Card abnormality is detected.
- **Alarm Delay:** This field specifies in seconds how long the delay between alarm activation and relay alarm activation should be.
- **Send Email:** This checkbox allows the user to enable the camera to send an email when an SD Card abnormality is detected.

To reset to default settings, click the Reset Defaults button. To refresh the page, click the Refresh button. To save the settings, click the Save button.

5.4.3.3.2 Network

This tab allows the user to set the camera's response to a Network related abnormality. Below is a screenshot of the Network tab screen:



Below is an explanation of the fields on the Network settings tab:

- **Event Type:** This dropdown box allows the user to select which Network abnormality to set event triggers for. The 2 options are Disconnection and IP Conflict.
- **Enable:** This checkbox enables the Network abnormality trigger for the camera.
- **Record:** This checkbox allows the user to enable the camera to record video when a network abnormality is detected.
- **Record Delay:** This field specifies in seconds how long the delay between alarm activation and recording should be.
- **Relay Out:** This checkbox allows the user to enable the camera to trigger an alarm when a network abnormality is detected.
- **Alarm Delay:** This field specifies in seconds how long the delay between alarm activation and relay alarm activation should be.

To reset to default settings, click the Reset Defaults button. To refresh the page, click the Refresh button. To save the settings, click the Save button.

5.4.3.3 Illegal Access

This tab allows the user to set the camera's response to an Illegal Access related abnormality. Below is a screenshot of the Illegal Access tab screen:



Below is an explanation of the fields on the Illegal Access settings tab:

- **Enable:** This checkbox enables the Illegal Access abnormality trigger for the camera.
- **Login Failure:** This field allows the user to specify how many failed login attempts must be attempted to trigger an Illegal Access abnormality event.
- **Relay Out:** This checkbox allows the user to enable the camera to trigger an alarm when illegal access is detected.
- **Alarm Delay:** This field specifies in seconds how long the delay between alarm activation and relay alarm activation should be.
- **Send Email:** This checkbox allows the user to enable the camera to send an email when illegal access is attempted.

To reset to default settings, click the Reset Defaults button. To refresh the page, click the Refresh button. To save the settings, click the Save button.

5.4.4 Storage

This menu section allows the user to change storage settings for the camera.

5.4.4.1 Schedule

The schedule menu manages the recording schedule for the camera. This menu has 3 tabs: Record Schedule, Snapshot Schedule, and Holiday Schedule.

5.4.4.1.1 Record Schedule

This tab is where video recording settings are configured. Below is a screenshot of the Record Schedule settings screen:

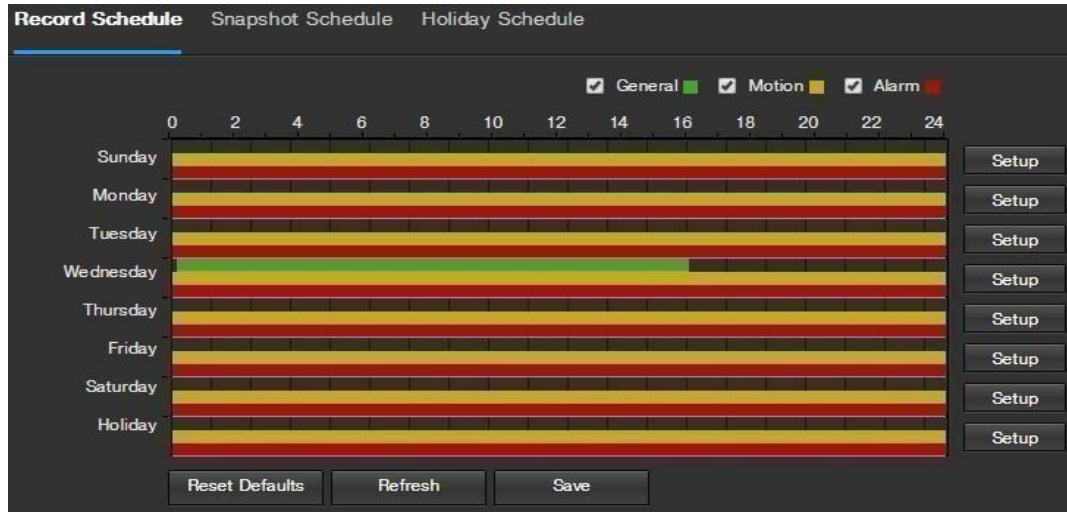

Below is an explanation of the fields on the Record Schedule settings tab:

Record Type: These checkboxes allow the user to select which recording type they want to configure on the schedule. There are 3 types of recordings:

- **General:** General recording means that the camera captures all footage for the specified time period. General recording is represented by the color green.
- **Motion:** Motion Detection recording means that the camera captures only footage when the motion detection alarm is activated. Motion recording is represented by the color yellow.
- **Alarm:** Alarm recording means that the camera captures only footage when an alarm is activated. Alarm recording is represented by the color red.
- **Video Recording Schedule:** To specify a video recording range, first select the type of recording desired, then click and drag on time bar for the desired date. To edit multiple days at once, drag the cursor further up or down to cover the other days.
- **Setup:** Clicking this button opens a screen that allows for recording periods to be set for each day and for each recording type. There are a total of 6 periods that can be set.

To reset to default settings, click the Reset Defaults button. To refresh the page, click the Refresh button. To save the settings, click the Save button.

5.4.4.1.2 Snapshot Schedule

This tab is where snapshot recording settings are configured. Below is a screenshot of the Snapshot Schedule settings screen:

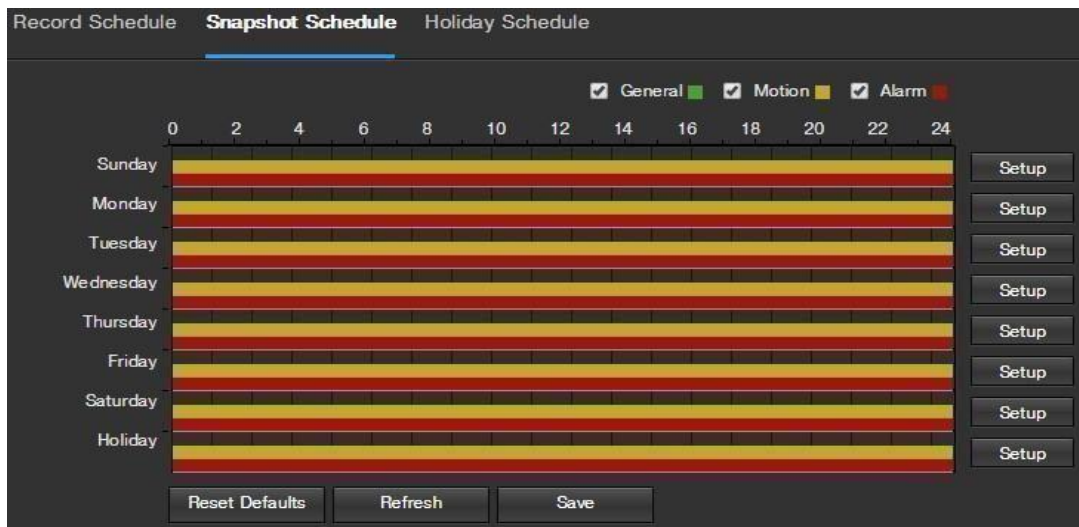

Below is an explanation of the fields on the Snapshot Schedule settings tab:

- **Record Type:** These checkboxes allow the user to select which snapshot type they want to configure on the schedule. There are 3 types of snapshots:
 - **General:** General means that the camera will take snapshots during the specified time period. General recording is represented by the color green.
 - **Motion:** Motion Detection means that the camera only takes snapshots when the motion detection alarm is activated. Motion recording is represented by the color yellow.
 - **Alarm:** Alarm means that the camera only takes snapshots when an alarm is activated. Alarm recording is represented by the color red.
- **Snapshot Recording Schedule:** To specify a snapshot range, first select the type of snapshot desired, then click and drag on time bar for the desired date. To edit multiple days at once, drag the cursor further up or down to cover the other days.
 - **Setup:** Clicking this button opens a screen that allows for snapshot periods to be set for each day and for each snapshot type. There are a total of 6 periods that can be set.

To reset to default settings, click the Reset Defaults button. To refresh the page, click the Refresh button. To save the settings, click the Save button.

5.4.4.1.3. Holiday Schedule

This tab is where holiday settings are configured. Below is a screenshot of the Holiday Schedule settings screen:

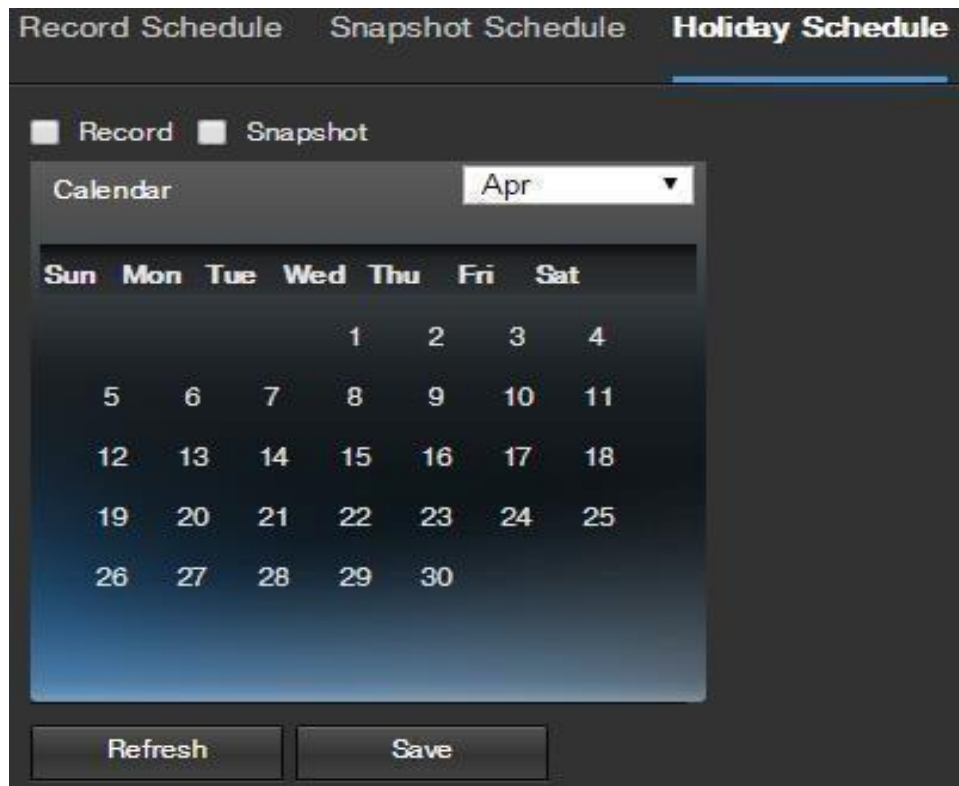

Below is an explanation of the fields on the Holiday Schedule settings tab:

- **Record Type:** These checkboxes allow the user to select which recording type they want to configure on the schedule. There are 2 types of recordings:
 - **Record:** This checkbox is referring to video recording.
 - **Snapshot:** This checkbox is referring to snapshot recording.
- **Calendar:** This calendar allows the user to select days to designate as holidays. Once a day is designated, it can be customized to stop recording or snapshots for that day by using the Record and Snapshot checkboxes.

To refresh the page, click the Refresh button. To save the settings, click the Save button.

5.4.4.2 Destination

This menu controls where recorded media is stored. There are 4 tabs in this menu: Path, SD Card, FTP, and NAS.

5.4.4.2.1 Path

This tab is where the user can designate a path for recorded video and snapshots to reside in. Below is a screenshot of the Path tab:

Path				SD Card				FTP				NAS			
Record				Snapshot											
Event Type	Scheduled	Motion Detect	Alarm	Event Type	Scheduled	Motion Detect	Alarm	Event Type	Scheduled	Motion Detect	Alarm	Event Type	Scheduled	Motion Detect	Alarm
SD Card	<input checked="" type="checkbox"/>	<input checked="" type="checkbox"/>	<input checked="" type="checkbox"/>	SD Card	<input checked="" type="checkbox"/>	<input checked="" type="checkbox"/>	<input checked="" type="checkbox"/>	SD Card	<input checked="" type="checkbox"/>	<input checked="" type="checkbox"/>	<input checked="" type="checkbox"/>	SD Card	<input checked="" type="checkbox"/>	<input checked="" type="checkbox"/>	<input checked="" type="checkbox"/>
FTP	<input type="checkbox"/>	<input type="checkbox"/>	<input type="checkbox"/>	FTP	<input type="checkbox"/>	<input type="checkbox"/>	<input type="checkbox"/>	FTP	<input type="checkbox"/>	<input type="checkbox"/>	<input type="checkbox"/>	FTP	<input type="checkbox"/>	<input type="checkbox"/>	<input type="checkbox"/>
NAS	<input type="checkbox"/>	<input type="checkbox"/>	<input type="checkbox"/>	NAS	<input type="checkbox"/>	<input type="checkbox"/>	<input type="checkbox"/>	NAS	<input type="checkbox"/>	<input type="checkbox"/>	<input type="checkbox"/>	NAS	<input type="checkbox"/>	<input type="checkbox"/>	<input type="checkbox"/>

Reset Defaults Refresh Save

Below is an explanation of the fields on the Path settings tab:

- **Event Type:** This column designates storage options available to the camera. The options are SD Card, FTP, and NAS.
- **Record Type:** These columns designate which recording type should be recorded to which event type. Check the box at the intersection of the record type and event type to designate where that recording should be sent to.

To reset to default settings, click the Reset Defaults button. To refresh the page, click the Refresh button. To save the settings, click the Save button.

5.4.4.2.2 SD Card

This tab is where the user can change SD card settings. Below is a screenshot of the SD Card tab:

Path				SD Card				FTP				NAS			
Device Name	Status	Attribute	Used Capacity/Total Capacity	Device Name	Status	Attribute	Used Capacity/Total Capacity	Device Name	Status	Attribute	Used Capacity/Total Capacity	Device Name	Status	Attribute	Used Capacity/Total Capacity
Disk1	Normal	Read & Write	3327.6M/3773.5M												

Read Only Read & Write Hot Swap Refresh Format

Below is an explanation of the fields on the SD Card settings tab:

- **Device Name:** This column designates the name of the SD card that is currently in the camera.
- **Status:** This column designates the status of the SD card.
- **Attribute:** This column designates the read/write attributes for the SD card. By default, this is Read & Write.
- **Used Capacity/Total Capacity:** This column shows the available memory on the SC card.
- **Read Only:** This button allows the user to designate an SD card as read only.
- **Hot Swap:** This button allows the user to physically remove the SD card and replace it with another safely.
- **Refresh:** This button refreshes the SD card table.
- **Format:** This button formats the SD card.

5.4.4.2.3 FTP

This tab is where the user can change FTP settings. Below is a screenshot of the FTP tab:

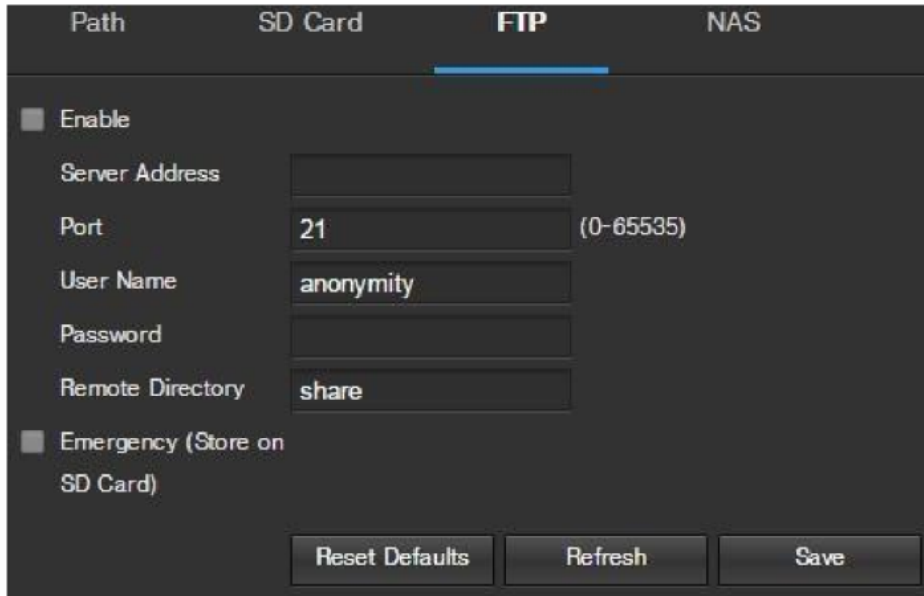

The screenshot shows a web interface with four tabs: Path, SD Card, FTP, and NAS. The FTP tab is selected and highlighted with a blue underline. The settings for the FTP tab are as follows:

- Enable
- Server Address: [Empty text box]
- Port: 21 (0-65535)
- User Name: anonymity
- Password: [Empty text box]
- Remote Directory: share
- Emergency (Store on SD Card)

At the bottom of the FTP settings panel, there are three buttons: Reset Defaults, Refresh, and Save.

Below is an explanation of the fields on the FTP settings tab:

- **Enable:** This checkbox allows the user to enable FTP uploading for the camera's recorded media.
- **Server Address:** This field allows the user to designate a DDNS address for the FTP server.
- **Port:** This field allows the user to designate the port number for the FTP server.
- **User Name:** This field allows the user to input the username used to login to the FTP server.
- **Password:** This field allows the user to input the password used to login to the FTP server.
- **Remote Directory:** This field allows the user to specify a remote directory on the FTP to send the recorded media to.
- **Emergency (Store on SD Card):** This checkbox allows the camera to store recorded media on the SD card in case the FTP server is unavailable.

To reset to default settings, click the Reset Defaults button. To refresh the page, click the Refresh button. To save the settings, click the Save button.

5.4.4.2.4 NAS

This tab is where the user can change NAS settings. Below is a screenshot of the NAS tab:

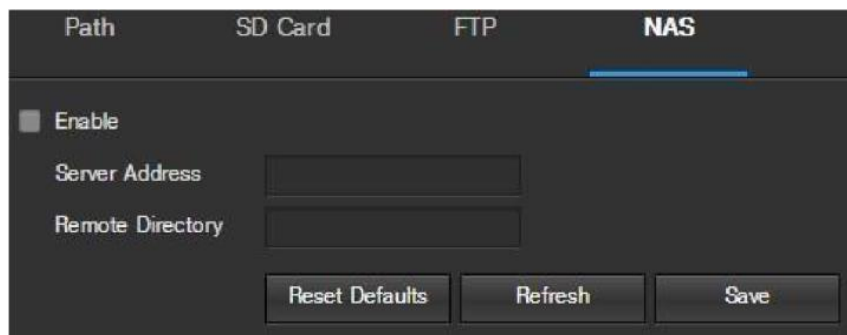

The screenshot shows a web interface with four tabs: Path, SD Card, FTP, and NAS. The NAS tab is selected and highlighted with a blue underline. The settings for the NAS tab are as follows:

- Enable
- Server Address: [Empty text box]
- Remote Directory: [Empty text box]

At the bottom of the NAS settings panel, there are three buttons: Reset Defaults, Refresh, and Save.

Below is an explanation of the fields on the NAS settings tab:

- **Enable:** This checkbox allows the user to enable NAS uploading for the camera's recorded media.
- **Server Address:** This field allows the user to designate a DDNS address for the NAS server/device.
- **Remote Directory:** This field allows the user to specify a remote directory on the NAS to send the recorded media to.

To reset to default settings, click the Reset Defaults button. To refresh the page, click the Refresh button. To save the settings, click the Save button.

5.4.4.3 Record Control

This menu is where general recording settings are configured. Below is a screenshot of the record control menu:

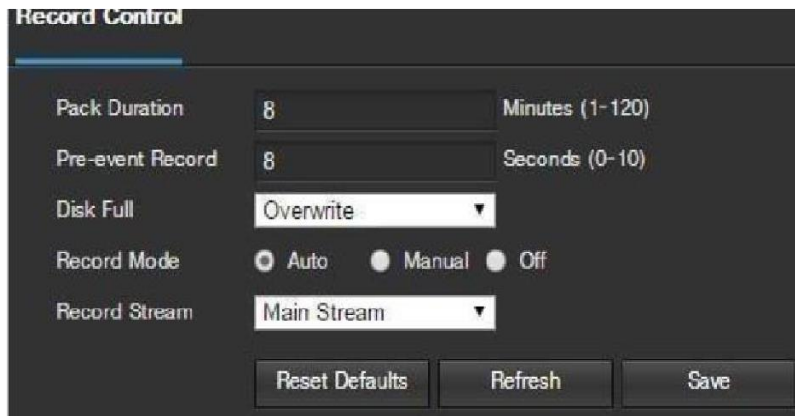

The screenshot shows a 'Record Control' settings panel with a dark background. It includes five configuration rows: 'Pack Duration' with a value of 8 and a unit of 'Minutes (1-120)'; 'Pre-event Record' with a value of 8 and a unit of 'Seconds (0-10)'; 'Disk Full' with a dropdown menu set to 'Overwrite'; 'Record Mode' with three radio buttons for 'Auto', 'Manual', and 'Off', where 'Auto' is selected; and 'Record Stream' with a dropdown menu set to 'Main Stream'. At the bottom of the panel are three buttons: 'Reset Defaults', 'Refresh', and 'Save'.

Below is an explanation of the fields on the Record Control settings tab:

- **Pack Duration:** This field allows the user to set how many minutes each file is comprised of.
- **Pre-event Record:** This field allows the user to specify how many seconds before an event should be recorded.
Disk Full: This dropdown box allows the user to designate what the camera should do when the disk is full. There are 2 options: Overwrite or Stop.
- **Record Mode:** This set of radio buttons allows the user to designate the recording mode. The options are Auto, Manual, and Off.
Record Stream: This dropdown box allows the user to specify which stream to record. The options are main stream and sub stream.

To reset to default settings, click the Reset Defaults button. To refresh the page, click the Refresh button. To save the settings, click the Save button.

5.4.4.4. Cloud Storage

This menu redirects the user to the Amcrest Cloud web site. At this website (amcrestcloud.com) users can register for new accounts as well as view or modify existing accounts.

For more information on Amcrest Cloud visit: amcrestcloud.com

5.4.5 System

This menu section allows the user to change general settings for the camera.

5.4.5.1 General

This menu controls where general settings are configured. There are 2 tabs in this menu: General and Date & Time.

5.4.5.1.1 General

This tab is where the user can configure some basic camera settings. Below is a screenshot of the General tab:



Below is an explanation of the fields on the General settings tab:

- **Device Name:** This field allows the user to change the device's name.
- **Language:** This dropdown box allows the user to change the language used in the camera.
- **Video Standard:** This dropdown box allows the user to select either the NTSC or PAL video standard.

To reset to default settings, click the Reset Defaults button. To refresh the page, click the Refresh button. To save the settings, click the Save button.

5.4.5.1.1 Date & Time

This tab is where the user can configure the date and time settings for the camera. Below is a screenshot of the Date & Time tab:

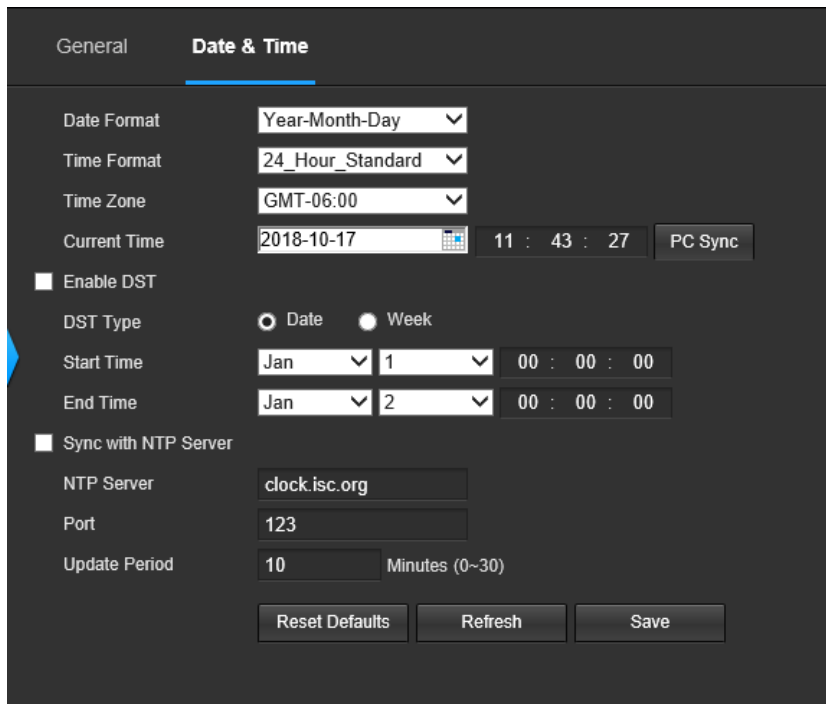

Below is an explanation of the fields on the Date & Time settings tab:

- **Date Format:** This dropdown box allows the user to change the date format used in the camera.
- **Time Format:** This dropdown box allows the user to change the time format used in the camera.
- **Time Zone:** This dropdown box allows the user to change the time zone used in the camera.
- **Current Time:** This field allows the user to enter in the date and time manually. Clicking the PC Sync button allows the camera to sync with a Network Time Protocol (NTP) server.
- **Enable DST:** This checkbox allows the user to enable daylight savings time for the camera.
- **DST Type:** This radio button allows the user to select whether DST is based on the week, or a specific day.
- **Start Time:** This dropdown box and field allow the user to enter in the start time for DST.
- **End Time:** This dropdown box and field allow the user to enter in the end time for DST.
- **Synchronize with NTP:** This checkbox allows the user to enable the camera’s synchronization with an NTP server.
- **NTP Server:** This field allows the user to enter in an NTP server.
- **Port:** This field allows the user to enter in the port number for the NTP server.
- **Update Period:** This field allows the user to enter in the update period time. This number designates how frequently the camera pings the NTP server to ensure it has the correct time. The range is from 0-30 minutes.

To reset to default settings, click the Reset Defaults button. To refresh the page, click the Refresh button. To save the settings, click the Save button.

5.4.5.2. Manage Users

This menu allows the user to change the user accounts on the camera. By default, the camera only has the admin account which has all rights/authorities. Additional accounts can be created on this screen. Below is a screenshot of the account screen:

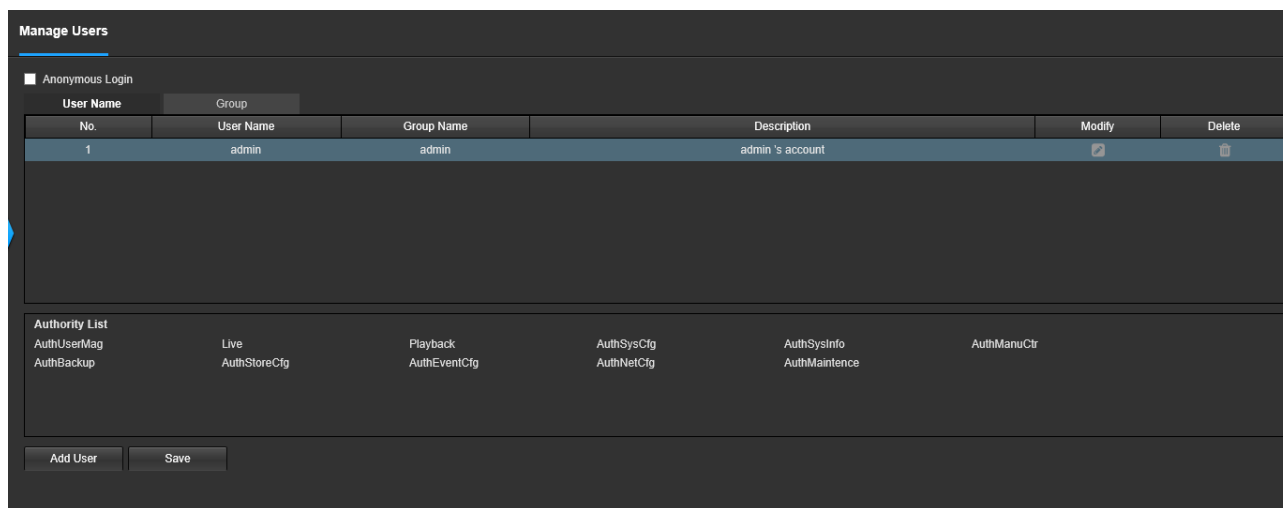

Below is an explanation of the fields on the Account screen:

- **Anonymous Login:** This checkbox allows the user to enable the anonymous login feature. This allows all user account names to remain hidden on this screen.
- **User Name:** This tab shows the usernames available on the camera.
- **Group:** This tab shows the user groups available on the camera.
- **No.:** This column shows the user’s number on the user list.

- **User Name:** This column shows the usernames of the different accounts on the camera.
- **Group Name:** This column shows the group of the different accounts on the camera.
- **Description:** This column shows a description of the account.
- **Modify:** This column allows the user to modify the user account.
- **Delete:** This column allows the user to delete a user account. Note: The admin account cannot be deleted.
- **Authority List:** This box shows which user rights/authorities are assigned to an account.
- **Add User:** This button allows the user to add a new user to the camera.

5.4.5.3 Default Settings

This screen allows the user to reset the camera and all its settings to the factory settings.

Below is a screenshot of the Default screen:

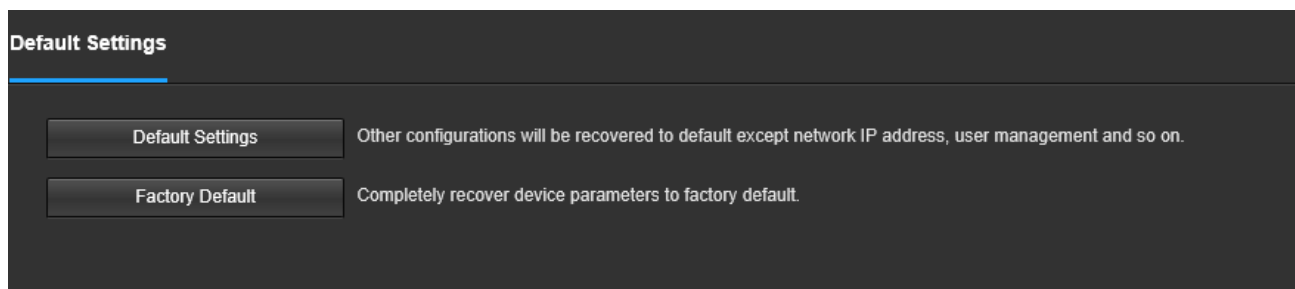

Below is an explanation of the items listed in this field:

Default Settings: Only the IP address, user management, and other settings can be recovered after reset.

Factory Default: Completely resets the camera to factory default settings. No settings can be recovered after the camera has been returned to its factory default settings.

5.4.5.4 Import/Export

This screen allows the user to import or export settings from the camera. Below is a screenshot of the Import/Export screen:

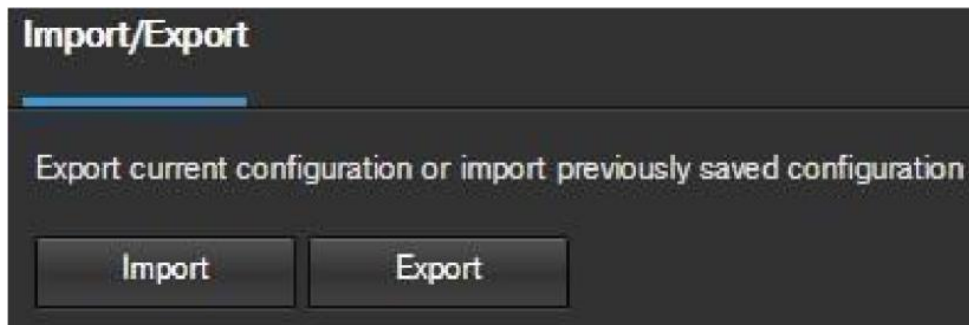

To import settings, click the Import button. To export settings, click the Export button.

5.4.5.5 Auto Maintain

This screen allows the user to set auto maintenance settings for the camera. Below is a screenshot of the Auto Maintain screen:

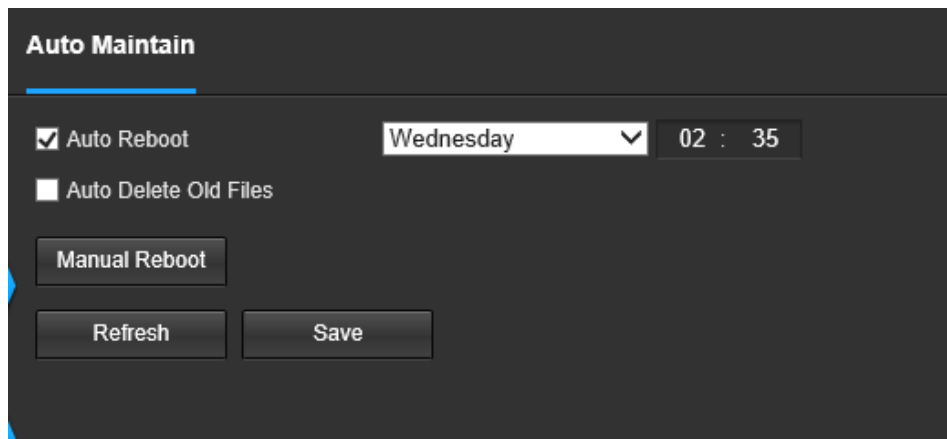

Below is an explanation of the fields on the Auto Maintain screen:

- **Auto Reboot:** This checkbox allows the user to enable the auto reboot function. The dropdown box and field to the right of this checkbox allow the user to specify what date and time of the week the camera will auto reboot.
- **Auto Delete Old Files:** This checkbox allows the user to enable the auto deletion of old files on the camera.
- **Manual Reboot:** This button allows the user to manually reboot the camera.

To refresh the page, click the Refresh button. To save the settings, click the Save button.

5.4.5.6. Upgrade

This menu allows the user to upgrade the camera's firmware. Below is a screenshot of the Upgrade screen:

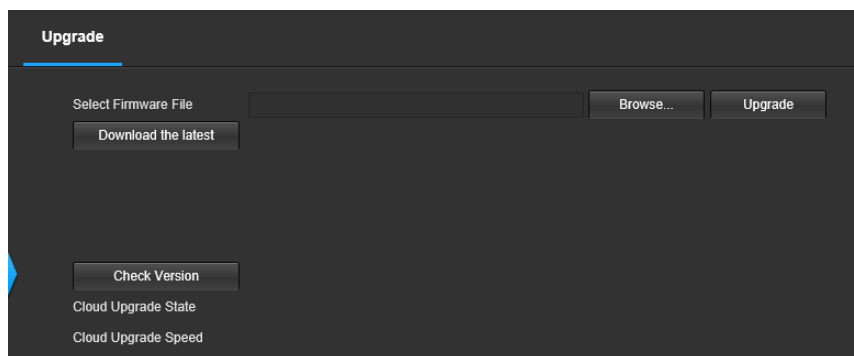

To upgrade the firmware for your camera, follow the steps provided below:

- Go to amcrest.com/firmware-subscribe
- You will be taken to an Amcrest firmware downloads page. Search for the model number of your camera and download the latest firmware file.
- Return to the web user interface for your camera and press the **Browse** button to locate and import the firmware file you just downloaded.
- Once the firmware file has been imported, click **Upgrade**.
- The device will reset, return to the web user interface. The upgrade is now complete.

Note: When upgrading the camera's firmware, do not disconnect the internet or power from the camera.

5.4.6 Information

This menu section allows the user to view information about the camera for reference purposes.

5.4.6.1 Version

This screen allows the user to see various information about the camera’s software versions, as well as other information. Below is a screenshot of the camera’s version screen:

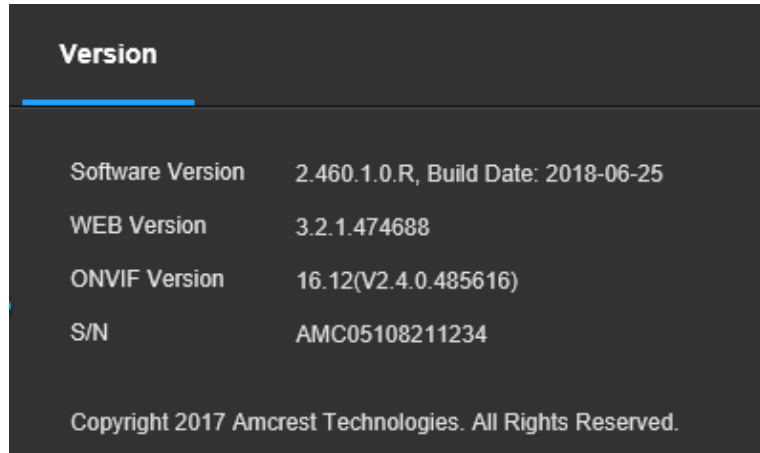

On this screen, software version, web interface version, and ONVIF version are displayed. Also, the S/N (Token ID) is displayed here.

5.4.6.2 Log

This screen is where the camera’s activity log is kept. Below is a screenshot of the Log screen:

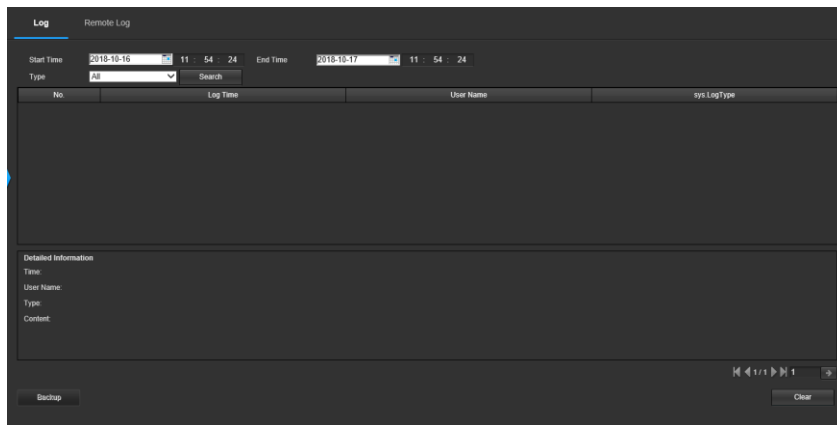

To view logs for a specific time period, modify the start time and end time fields, choose the type of event (system, setting, data, event, record, manage users, clear log), and click search.

To back up the log, click the Backup button. To clear the log, click the Clear button.

5.4.6.2.1. Remote Log

This tab allows the user to enable and access remote logs within the camera. Below is a screenshot of this menu:

Log **Remote Log**

enable

IP Address

Port (1~65534)

Device Number (0~23)

To use this menu, check the **enable** check box to enable remote log functionality. Enter the IP address, port number and device number of the device you would like to pull remote logs from. To save your settings, click **Save**. If you would like to refresh the screen to show applied settings, click **Refresh**. To set the screen back to its original default settings, click **Reset Defaults**.

5.4.6.3 Online Users

This screen allows the user to see which users are online. Below is a screenshot of the Online Users screen:

Online Users Help

No.	Username	User Local Group	IP Address	User Login Time
1	admin	admin	99.46.173.156	2015-05-01 14:13:36

Click Refresh to refresh this table.

5.5 Alarm

This screen is where the alarm log is kept. Below is a screenshot of the alarm screen:

The table on the right shows the alarm log and all the alarm instances that have occurred. The checkboxes allow the user to narrow down which alarms they want to see in the alarm log. Clicking the checkbox next to Prompt will cause the system to pop up a dialog box anytime an alarm is triggered. Clicking the checkbox next to Play Custom Alarm will use a custom alarm sound for the alarm prompt. Click the Browse button to search for a custom alarm sound to use.

5.6 Logout

Clicking the logout button will log out the user.

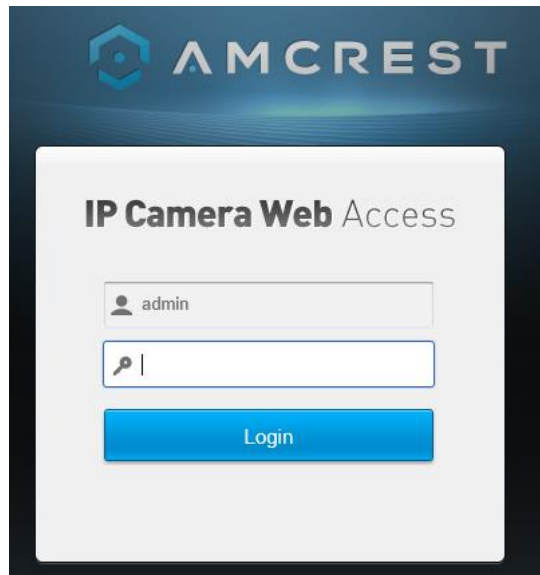

6. FAQs/Troubleshooting

1. The camera does not boot up properly.

Below are a few possible reasons why this may be occurring:

- The power input is not correct voltage.
- The power cable connection is not secured correctly.
- The firmware was upgraded incorrectly.

2. Camera often automatically shuts down or stops running.

Below are a few possible reasons why this may be occurring:

- The input voltage is too low or is not stable.
- The insides of the camera have accumulated too much dust.
- The temperature is either too hot or too cold.
- The hardware is malfunctioning.

3. Real-time video color is distorted.

Below are a few possible reasons why this may be occurring:

- The camera is not compatible with the monitor.
- The camera color or brightness settings are not correctly configured.

4. The timestamp is not displaying the correct time.

The time and date settings may not be configured correctly. You can take the following steps to resolve the issue:

- Log into your camera's web user interface via a laptop or PC.
- Navigate to **Setup>>System>>General**
- Click on the **Date & Time** tab.
- Click on **PC Sync** to sync the date and time.
- Click **Save** to save and apply the new date and time settings.

5. Motion detection does not work.

Below are a few possible reasons why this may be occurring:

- The motion detection time period may be incorrectly configured.
- Motion detection zone setup is not correctly configured.
- Motion detection sensitivity is too low.
-

6. Web Access isn't working.

Below are a few possible reasons why this may be occurring:

- Windows version is pre -Windows 2000 service pack 4. Use a more recent version of Windows.
- ActiveX controls have been disabled.
- The PC is not using DirectX 8.1 or higher. Upgrade to a more recent version of DirectX.
- The camera is having network connection errors.
- Web access may be setup incorrectly.
- The username or password may be incorrect.

7. Web Access live view is only displaying a static picture.

Below are a few possible reasons why this may be occurring:

- The network speed is not enough to transfer video data via web access.

- The client PC may have limited resources.
- Multicast mode may be causing this issue.
- A privacy mask or screensaver may be enabled.
- The logged in user may not have enough rights to monitor real-time playback.
- The camera's local video output quality is not enough.

8. The camera is unable to connect to WiFi.

Below are a few possible reasons why this may be occurring:

- The network is not stable.
- The WiFi settings in the camera are not configured.
- Interference from obstructions between camera and router.
- The distance is too far for the camera to connect.

9. The alarm signal cannot be disarmed.

Below are a few possible reasons why this may be occurring:

- An alarm may be setup incorrectly.
- An alarm output may have been manually opened.
- There may be an error in the camera's firmware.

10. Alarms are not working.

Below are a few possible reasons why this may be occurring:

- The alarm is not setup correctly.
- The alarm cable is not connected correctly.
- The alarm input signal is not correctly configured.
- There are two loops connected to one alarm device.

11. Downloaded files cannot be played back.

Below are a few possible reasons why this may be occurring:

- The media player software on the PC may not be able to read the file format.
- The PC may not have DirectX 8.1 or higher.
- The PC may not have Windows XP or higher.

Glossary of Terms

- Abnormality – Any malfunction in terms of storage of data to the SD card.
- Alarm Delay – The gap in time between alarm activation and Relay alarm activation.
- Alternate Gateway – The node on the computer network that the network software uses when an IP address does not match any other routes in the routing table, and when the default gateway is not available.
- Anti-Dither – This time value controls how long the alarm signal lasts. The values in this field can range from 5 to 600 seconds. Based on motion detection, a buzzer can go off, a tour can begin, a snapshot can be taken, or the camera can begin recording.
- DDNS – Stands for Dynamic Domain Name System. DDNS is a method of automatically updating a name server in the Domain Name System (DNS), often in real time, with the active DNS configuration of its configured hostnames, addresses or other information.
- Default Gateway – The node on the computer network that the network software uses when an IP address does not match any other routes in the routing table.
- DHCP – Dynamic Host Configuration Protocol is a network protocol that enables a server to automatically assign an IP address to a computer from a defined range of numbers (i.e., a scope) configured for a given network.
- Fluency – Fluency described the lack of stuttering or excessive delay in a video stream. Fluency usually comes at the expense of video quality when a network is constrained.
- IP Address – Internet Protocol Address is a unique numerical label assigned to each device connected to a computer network. The IP address allows communication between different devices on a network.
- Main Stream – Main Stream is the main streaming protocol for the camera. Main stream uses more bandwidth and attempts to keep quality and fluency high.
- NO/NC – Normally Open and Normally Closed are options for sensor type. These settings allow for different exposure types when capturing video and still images.
- NTP – Network Time Protocol is a networking protocol for clock synchronization between computer systems over packet-switched, variable-latency data networks.
- P2P – Peer-to-Peer is a decentralized communications model in which each party has the same capabilities and either party can initiate a communication session.
- PPPoE – Point to Point Protocol over Ethernet is a network protocol for encapsulating Point to Point Protocol data packets inside Ethernet frames.
- QR Code – Quick Response code is a type of digital barcode that enables devices to share complex data strings quickly.
- Record Delay – Record Delay specifies in seconds how long the delay between alarm activation and recording should be.
- Relay Out – Relay Out triggers a connected alarm (connected to the alarm port on the back of the camera) when an alarm on the camera is triggered.
- S/N – S/N stands for serial number. The S/N is unique to each camera and can be used to connect to different Amcrest apps and services to provide different methods of access to the camera.
- Sensitivity – Sensitivity is the amount of change required to increase the motion detected by a percentage. The lower the sensitivity, the more movement is required to trigger an alarm.
- SMTP – Simple Main Transfer Protocol is an Internet standard for electronic mail (e-mail) transmission.
- Static IP – An IP address that does not change.
- Sub Stream – Sub Stream is an alternative streaming protocol for the camera. Sub stream uses less bandwidth and attempts to keep fluency high at the expense of quality.
- Subnet Mask – a 32-bit number that masks an IP address, and divides the IP address into network address and host address.
- TCP/IP – TCP/IP stands for Transmission Control Protocol/Internet Protocol and it is the language/protocol that allows communication between internet connected devices, whether on a local network, or a on the Internet at large.
- Threshold – Threshold is the level that the motion detection needs to reach to trigger an alarm.
- UPnP – UPnP stands for Universal Plug and Play, and it is a protocol used to easily connect devices to the internet.

FCC Statement

1. This device complies with Part 15 of the FCC Rules. Operation is subject to the following two conditions: (1) this device may not cause harmful interference, and (2) this device must accept any interference received, including interference that may cause undesired operation.
2. The user's manual or instruction manual for an intentional or unintentional radiator shall caution the user that changes, or modifications not expressly approved by the party responsible for compliance could void the user's authority to operate the equipment. In cases where the manual is provided only in a form other than paper, such as on a computer disk or over the Internet, the information required by this section may be included in the manual in that alternative form, provided the user can reasonably be expected to have the capability to access information in that form.
3. (b) For a Class B digital device or peripheral, the instructions furnished the user shall include the following or similar statement, placed in a prominent location in the text of the manual: NOTE: This equipment has been tested and found to comply with the limits for a Class B digital device, pursuant to Part 15 of the FCC Rules. These limits are designed to provide reasonable protection against harmful interference in a residential installation. This equipment generates, uses and can radiate radio frequency energy and, if not installed and used in accordance with the instructions, may cause harmful interference to radio communications. However, there is no guarantee that interference will not occur in a particular installation. If this equipment does cause harmful interference to radio or television reception, which can be determined by turning the equipment off and on, the user is encouraged to try to correct the interference by one or more of the following measures: -- Reorient or relocate the receiving antenna. -- Increase the separation between the equipment and receiver. -- Connect the equipment into an outlet on a circuit different from that to which the receiver is connected. -- Consult the dealer or an experienced radio/TV technician for help.
4. RF exposure warning This equipment must be installed and operated in accordance with provided instructions and the antenna(s) used for this transmitter must be installed to provide a separation distance of at least 20 cm from all persons and must not be co-located or operating in conjunction with any other antenna or transmitter. End-users and installers must be provided with antenna installation instructions and transmitter operating conditions for satisfying RF exposure compliance.

IC Warning Statement

This device complies with Industry Canada's licence-exempt RSSs. Operation is subject to the following two conditions: (1) This device may not cause interference; and (2) This device must accept any interference, including interference that may cause undesired operation of the device. Le présent appareil est conforme aux CNR d'Industrie Canada applicables aux appareils radio exempts de licence. L'exploitation est autorisée aux deux conditions suivantes : (1) l'appareil ne doit pas produire de brouillage, et (2) l'utilisateur de l'appareil doit accepter tout brouillage radioélectrique subi, même si le brouillage est susceptible d'en compromettre le fonctionnement. This equipment complies with IC RSS-102 radiation exposure limits set forth for an uncontrolled environment. This equipment should be installed and operated with a minimum distance of 20cm between the radiator and any part of your body. Pour se conformer aux exigences de conformité CNR 102 RF exposition, une distance de séparation d'au moins 20 cm doit être maintenue entre l'antenne de cet appareil et toutes les personnes.

Appendix A: Toxic or Hazardous Materials or Elements

Component Name	Toxic or Hazardous Materials or Elements					
	Pb	Hg	Cd	Cr VI	PBB	PBDE
Sheet Metal(Case)	<input type="radio"/>	<input type="radio"/>	<input type="radio"/>	<input type="radio"/>	<input type="radio"/>	<input type="radio"/>
Plastic Parts (Panel)	<input type="radio"/>	<input type="radio"/>	<input type="radio"/>	<input type="radio"/>	<input type="radio"/>	<input type="radio"/>
Circuit Board	<input type="radio"/>	<input type="radio"/>	<input type="radio"/>	<input type="radio"/>	<input type="radio"/>	<input type="radio"/>
Fastener	<input type="radio"/>	<input type="radio"/>	<input type="radio"/>	<input type="radio"/>	<input type="radio"/>	<input type="radio"/>
Wire and Cable/Ac Adapter	<input type="radio"/>	<input type="radio"/>	<input type="radio"/>	<input type="radio"/>	<input type="radio"/>	<input type="radio"/>
Packing Material	<input type="radio"/>	<input type="radio"/>	<input type="radio"/>	<input type="radio"/>	<input type="radio"/>	<input type="radio"/>
Accessories	<input type="radio"/>	<input type="radio"/>	<input type="radio"/>	<input type="radio"/>	<input type="radio"/>	<input type="radio"/>

O: Indicates that the concentration of the hazardous substance in all homogeneous materials in the parts is below the relevant threshold of the SJ/T11363-2006 standard.

X: Indicates that the concentration of the hazardous substance of at least one of all homogeneous materials in the parts is above the relevant threshold of the SJ/T11363-2006 standard. During the environmental-friendly use period (EFUP) period, the toxic or hazardous substance or elements contained in products will not leak or mutate so that the use of these (substances or elements) will not result in any severe environmental pollution, any bodily injury or damage to any assets. The consumer is not authorized to process such kind of substances or elements, please return to the corresponding local authorities to process according to your local government statutes.

O: Indicates that the concentration of the hazardous substance in all homogeneous materials in the parts is below the relevant threshold of the SJ/T11363-2006 standard.

X: Indicates that the concentration of the hazardous substance of at least one of all homogeneous materials in the parts is above the relevant threshold of the SJ/T11363-2006 standard. During the environmental-friendly use period (EFUP) period, the toxic or hazardous substance or elements contained in products will not leak or mutate so that the use of these (substances or elements) will not result in any severe environmental pollution, any bodily injury or damage to any assets. The consumer is not authorized to process such kind of substances or elements, please return to the corresponding local authorities to process according to your local government statutes.

Note:

- To view setup videos for many of the steps outlined in this guide, go to <http://amcrest.com/videos>
- This user manual is for reference only. Slight differences may be found in the user interface.
- All the designs and software here are subject to change without prior written notice.
- All trademarks and registered trademarks mentioned are the properties of their respective owners.

To contact Amcrest support, please do one of the following:

- Visit <http://amcrest.com/contacts> and use the email form
- Call Amcrest Support using one of the following numbers
Toll Free US: (888) 212-7538
International Callers (Outside of US): +1-713-893-8956
USA: 713-893-8956
Canada: 437-888-0177
UK: 203-769-2757
- Email Amcrest Customer Support support@amcrest.com

Copyright Amcrest[©] 2019

