

YCR-M05

User Guide

Vacuum Cleaning Robot iClebo Arte

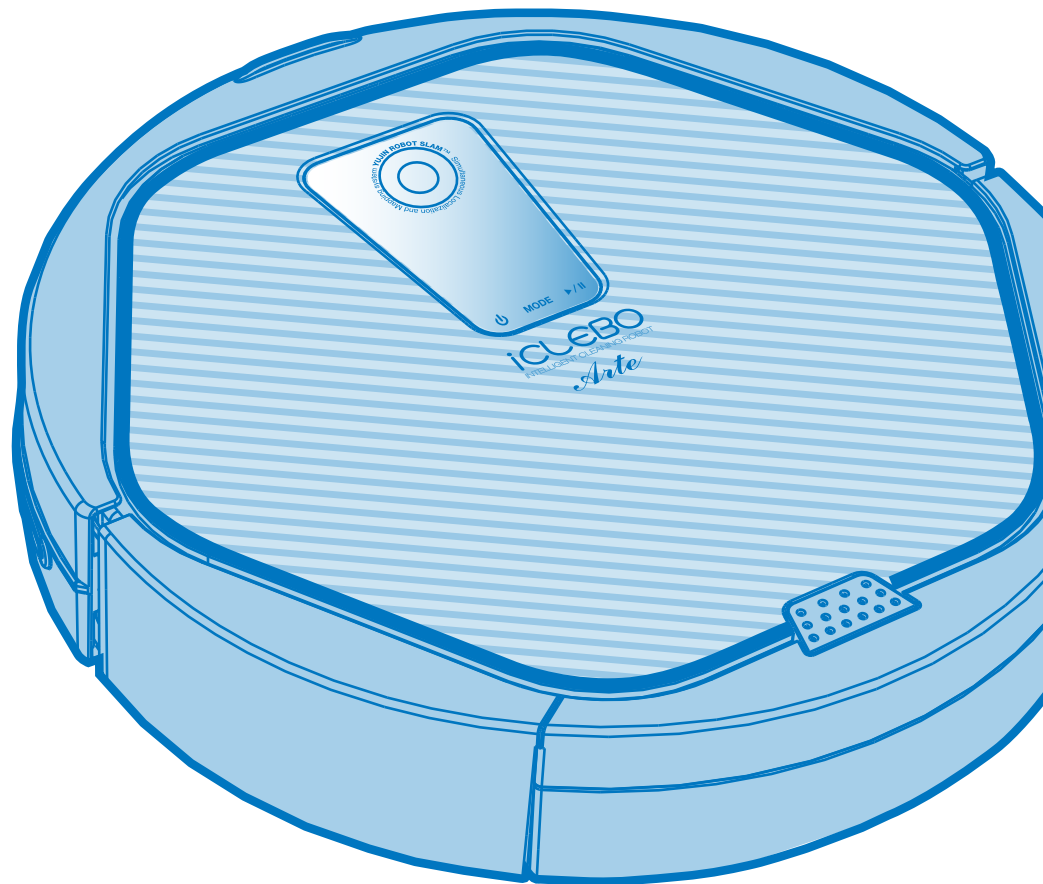

- Please be sure to read the Safety Precautions before use.

Safety precautions	-----	2
Components	-----	5
Reference	For effective cleaning -----	7
	Operating principles of robot cleaner	
Installing the robot cleaner	Check list before using -----	8
	• Assemble side-brush	
	• Insert remote control battery	
	• Assemble ultra microfiber mop	
	Check list before cleaning -----	9
	• Install base(charging) station	
	• Charging	
	• Current time setting	
	• Install area boundary tape	
Usage of robot cleaner	Using the robot cleaner -----	10
	• Power On/Off	
	• Start / Stop cleaning	
	• Using move, charge function	
	Cleaning mode -----	12
	Timer cleaning	
iClebo care & maintenance	Emptying dust bin and servicing the antibacterial filter -----	13
	Cleaning side brush	
	Cleaning sensor	
	Cleaning main brush	
	Cleaning front wheel	
Storage	-----	15
Check before repair report	-----	16
Display error message	-----	17

This content is for the user's safety and to prevent any property loss.
Read the below carefully and use it with care.



Users must be aware of necessary details for using this product.



Users must follow the instructions to avoid serious injury or death.



Users must follow the instructions to avoid light injury or product damage.

Precautions related to power



- **Do not force to bend the power cord or pressure it with heavy weight.**
→ It may cause electric shock or fire.
- **Keep the pin and interface of the power plug clean from dust or water.**
→ It may cause malfunction or electric shock.
- **Do not pull the power cord or touch the power plug with wet hands.**
→ It may cause electric shock or fire.
- **Do not use damaged power plug or power cord, loose outlet.**
→ It may cause electric shock or fire.
- **In case the water went inside the product, you must contact service center for check-up even the product was dried thoroughly.**
- **Do not put or pull the power plug consecutively.**
→ It may cause electric shock or fire.
- **In case of direct charging with adapter, connect the adapter to the charging socket of robot cleaner properly.**
→ It may cause electric shock or fire.

Precautions before using



Prohibition

- Do not touch the power cord of the charger with wet hands.
→ It may cause electric shock.



Warning

- Arrange any cables or wires before use to avoid them being wrapped or caught by the robot
→ It may cause fire or electric shock due to damaged cable.



Caution

- Remove light objects or fibers before use.
→ It may cause barrier or damage the object or clothing while robot is in use.



Caution

- Remove small or fragile objects from the cleaning area before use.
→ Fragile pottery or glass product must be removed.
→ Remove coins or expensive jewelries before cleaning.



Caution

- Tidy & remove objects from the floor.
→ Power cords, thin wires like phone chargers, pad, belts, thin towel, mats placed in front of the bathroom sink, entrance, utility room may get tangled with the wheel. Also table cloths, objects on the table or dining table may fall down.



Caution

- Empty the dust bin before operating the robot cleaner.
→ Suctioning function may not perform well if dust bin is full.



Caution

- Check the main components such as antibacterial filter, brush and dust bin are assembled properly before cleaning.
→ In case you operate the robot cleaner without the main components such as antibacterial filter or brush, it won't clean and it may cause breakdown.



Warning

- Do not operate robot cleaner when children or pets are left alone.
→ Robot cleaner may draw attention from children or pets. The children or pets may hurt themselves by playing with the wheels. If the robot cleaner is distracted while cleaning, it will recognize it as a barrier and certain areas may not be cleaned.



Caution

- Do not expose the power cord on the floor when installing charging station.
→ Robot cleaner may drag the power line while auto-charge or cleaning.



Warning

- Keep the top of the charging station away from water.
→ It may cause electric shock or fire.

Precautions while using



Warning

- In case the robot cleaner has unusual sound, smell or smoke turn off the robot immediately and place well away from flammable objects.

→ It may cause electric shock or fire.



Caution

- Do not use the robot cleaner on the table or any place high.

→ It may damage the product.



Caution

- In case of particular hardwood floor, scratch or damage may occur while using the product according to its material. Stop using in this case.



Caution

- In case plastic bin or big foreign substance was suctioned, remove it immediately.

→ It may cause serious damage to the robot cleaner when it's used for a long period with its suction duct clogged.



Caution

- Transfer the robot cleaner to other area when it's blocked by threshold of the entrance or porch while operating.



Caution

- Prevent the robot cleaner from suctioning liquid materials.

- Do not use the robot cleaner near flammables such as cigarette, hot materials or gasoline.

→ It may cause fire.



Caution

- Do not use it for outside.

Precautions after using



Warning

- In case foreign substance is stuck on the sensor part, it may malfunction.

Please clean the sensor regularly.



Warning

- Make sure to use the cleaning brush while the side power switch is off when removing foreign object.

→ If the robot cleaner operates all of the sudden, it may cause injury or serious damage to the product.



Warning

- In case the robot cleaner or components are destroyed, contact the manufacturer or service center for check-up.

→ It may cause electric shock or fire.



Warning

- In case of cleaning the charging station, pull out the power plug first for safety reasons.



Warning

- Mishandling the battery may cause an explosion or fire. At the end of service life return the battery to an official disposal point.

→ It may cause fire.



Caution

- Do not spray water directly or wipe the robot cleaner with volatile materials such as benzene, thinner or alcohol when mending the product.



Caution

- Do not force to press or pressure the bumper.

→ In case the bumper sensor is damaged, it may crash on the wall or with furniture.



Caution

- Do not disassemble, repair or convert the product. All repairs & servicing should be carried out by an Authorised Agent.

→ It may damage the product. Warranty will be voided.

Components

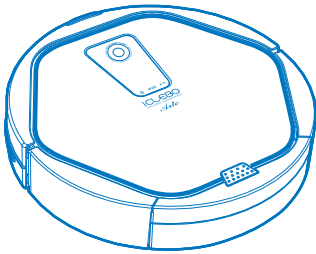

Robot cleaner

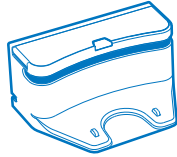

Charging station

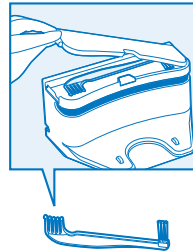

Cleaning brush

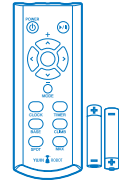

Remote control
(included battery)



User Guide

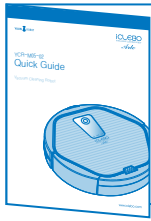

Quick Guide

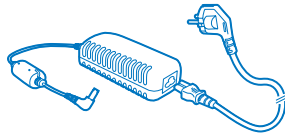

Adapter

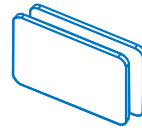

Antibacterial filter

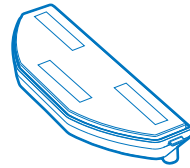

Mop plate



Side-brush(R)



Side-brush(L)



Area boundary
tape
(virtual wall)

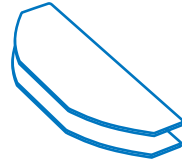

Ultra microfiber
wet mop

Detailed names of each parts

● Top of the robot cleaner

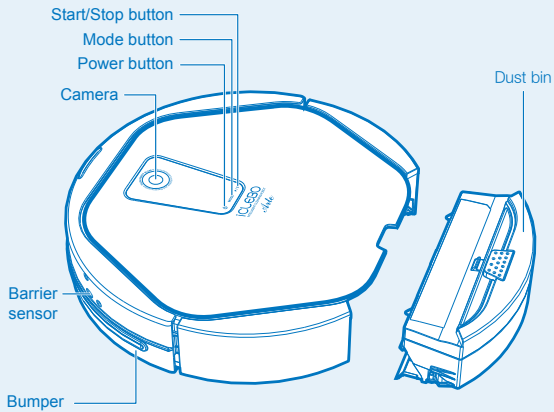

● Bottom of the robot cleaner

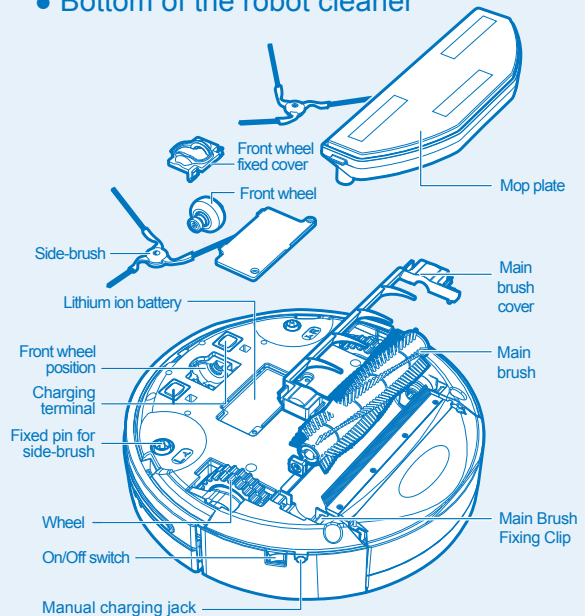

• Charging station

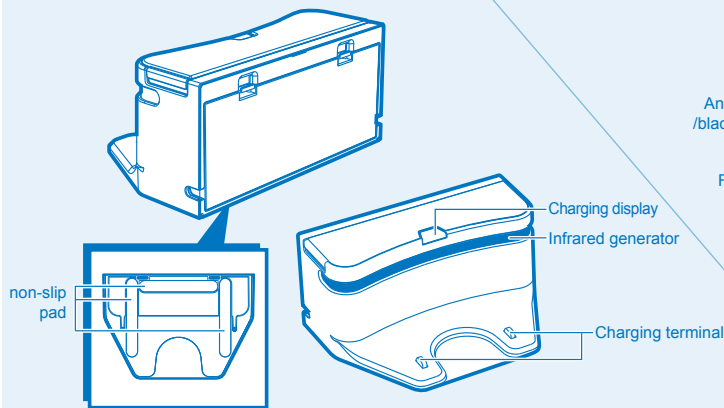

• Dust bin

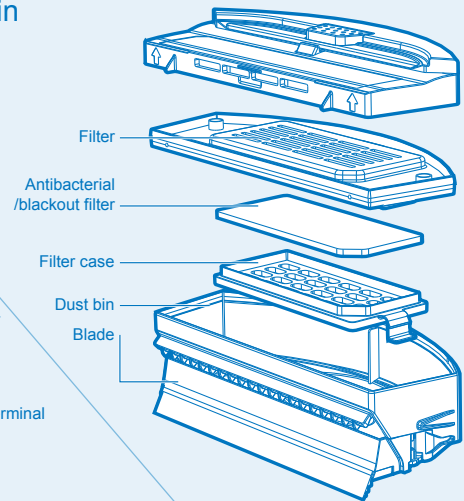

• Remote control

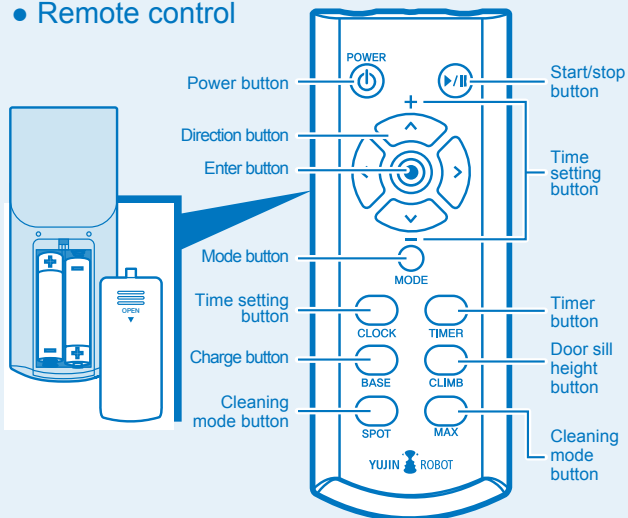

• Display screen

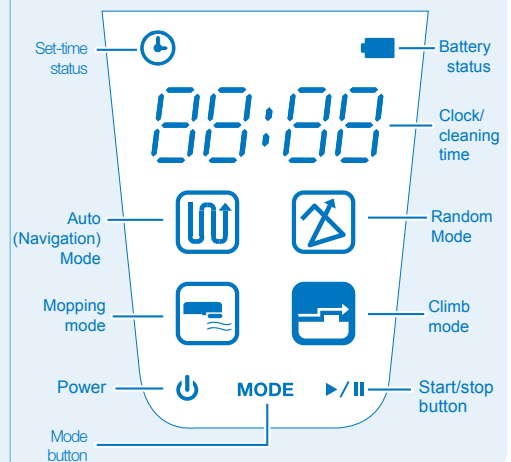

Remote controller

1. Press power button of the remote controller.
 2. Press start/stop (▶/||) button of the remote controller.
 3. Press power button to stop the operation.
 4. To change mode, press power button, and use mode button to select desired cleaning method, and then press start/stop (▶/||) button.
 5. Default mode is Auto + Climb.
If you want only floor cleaning, press Climb button of the remote controller to change to general mode and then proceed with the cleaning.
 6. Additional information for Max mode and Spot mode
If you want to use the cleaner as long as possible, clean in Max mode. In Max mode, it starts in Auto (Mapping) mode to perform overall cleaning, and when it is completed, it changes to Random mode for additional cleaning. (Cleaning of about 120~160 min. is possible according to indoor environment.)
- ※ In the floor environments such as carpet, rug, or patterned tiles or marble, set to Climb mode for cleaning.

For effective cleaning

Please follow the instructions below for high cleaning efficiency.

- Empty the dust bin after each use of the robot cleaner.
- Use Magnetic strip to confine the robot to an area or by closing the door.
(Refer to P.10 How to install entrance prevention tape)
- Fix up the magnetic strip not to apart from the floor.
- Remove all the non-fixed objects such as toys, magazines or shoes before cleaning.
- Do not lift up or move the robot cleaner manually while operating.
(If you do this, the robot loses its way and skips areas.)
- Make sure to charge with manual charging for at least 1 hour before using the vacuum cleaning robot for the first time. (Refer to P.9 How to charge manually)

Operating principles of robot cleaner

Principles of Vacuum Cleaning Robot

This product recognizes the ceiling and obstacles with camera and various sensors, and cleans by making a virtual map in CPU installed in the main body. It operates by drawing the most efficient map with self-decision of the finished cleaning area and the area to clean. (Camera navigation is disabled in random mode.) With about 20 detection sensors, it can avoid wall or objects (chair, vase, etc)

It climbs a door sill of up to 18mm, and And floor sensors help it to avoid falling down stairs. Be careful that pets or children do not force the robot to fall by playing with it.

Suction of robot cleaner

This product has one main brush, two side-brushes and vacuum suction dust. The dust on the floor is gathered by the rotating side brush, and is swept into the dust bin by the rotating main brush.

Check list before using

Assemble side-brush

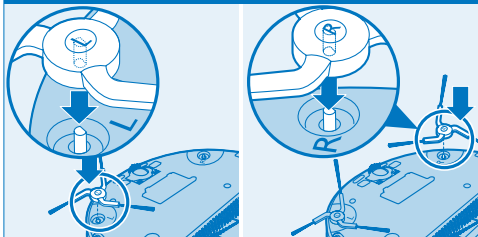

1. After flipping over the robotic vacuum cleaner, identify the positions of the left and right side brushes.
2. Match the L side brush to the L marked part in the direction of the groove, then push in firmly.
3. Match the R side brush to the R marked part in the direction of the groove, then push in firmly.

CAUTION



Fit the side brush into the protruding part of the robotic vacuum cleaner matching the same shape.

Insert remote control battery



There is no battery inside the remote controller at the time of purchase. Install 2 x AAA batteries before using it.

1. Push the cover of the backside of the remote controller downward to open.
2. Check (+)(-) of the battery and assemble.
3. Match the cover to the groove, and close until “click” sounds.

Assemble ultra microfiber mop

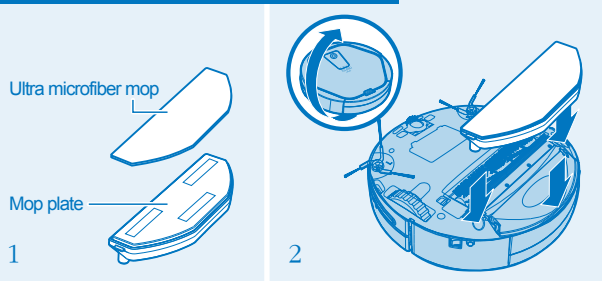

1. Turn over the vacuum cleaning robot, and install the mop plate by combining it to the fixing part of the main body.
2. If mopping mode is not used, separate and keep the mop plate separate from the main body.

- ※ In Mopping mode with mop plate attached, there may be cases that it is blocked by carpet, rug, or doorsill, and cannot go forward normally, so be careful. In such cases, moving the rug or carpet to one side and using Mopping mode is recommended.
- ※ In some floor environments, there may be cases of not being able to go forward normally. If it cannot go forward normally in the floor environment of marble floor or certain patterns, then also set Climb mode for cleaning.

Check list before cleaning

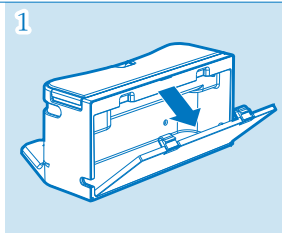
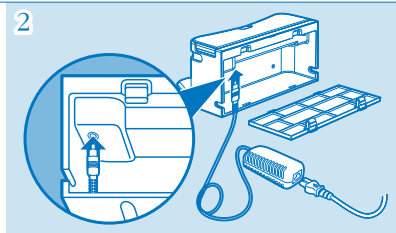
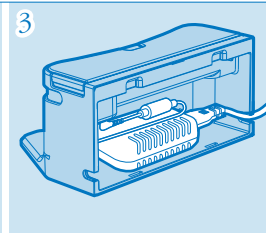
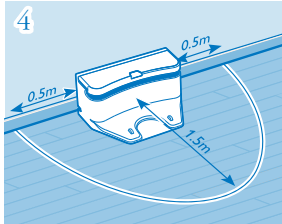
Install base (charging) station	1		2		3	
	4		<p>1. Open the cover of the backside of the charging station, and install the adapter with connected power plug as shown in the figure 2 above.</p> <p>2. Completely connect the charging jack of the adapter to the jack inside the charging station.</p>			

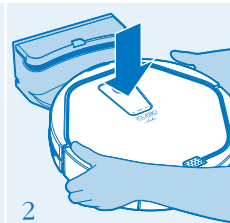
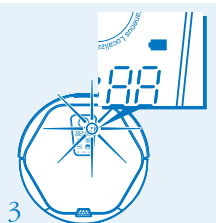
Charging	<p>Battery is discharged at the time of the purchase of the product, so it must be fully charged before using the robot for the first time.</p>		
1	2	3	<p>※ Battery colour change on the display</p> <ul style="list-style-type: none"> - Green: Battery is fully charged - Yellow: Remaining battery is 50% or less - Red: Remaining battery is 20% or less
			
<p>1. Turn on the power switch on the side of the product.</p> <p>2. Correctly match the charging pin on the bottom of the main body to the socket of the charging station, and start the charging.</p> <p>>> The battery status in the display window blinks and charging starts.</p> <p>If battery is completely discharged, “Lo” is displayed in the display window.</p> <p>3. Red, Yellow and Green light will be blinking in order (consequently) on the display window according to battery charging condition while robot charging and green light is changed to keep on the display window when the battery is full.</p>			
<p>[Auto-charge during use]</p> <p>※ When the battery is low during an operation, this product moves to the charging station and performs auto charging. After the charging is completed, it finishes cleaning the remaining space, and returns to the charging station.</p> <p>※ When the battery is low, this product is set to return to the starting place of the cleaning. So if it started from a place other than the charging station, it returns to the place near the starting place of the cleaning.</p> <p>※ Change of the Charging Indicator colour on Charging Station</p> <ul style="list-style-type: none"> - Red: robot cleaner is in operation away from the docking station, or the charging connector between the cleaner and docking station is not properly connected. - Green Blinking: Recharging - Green: Recharge completed 			

Current Time setting

※ Make sure to set time for timer cleaning.

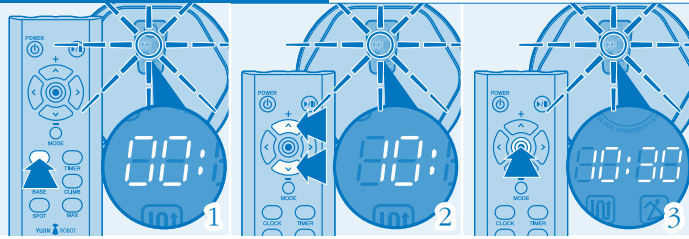

1. Press the Clock button on the remote control. Time display of the display screen will flash.
2. Set "hour" with (+)(-) button of the remote controller, and press Enter button.

3. Press Enter button to confirm the setting.
4. Set "minute" with (+)(-) button of the remote controller, and press Enter button
5. Press Enter button to confirm the setting.
6. When the time is set, it confirms the setting with beep sound.

Install area boundary tape

※ Attach it on the space to prevent the vacuum cleaning robot from entering.

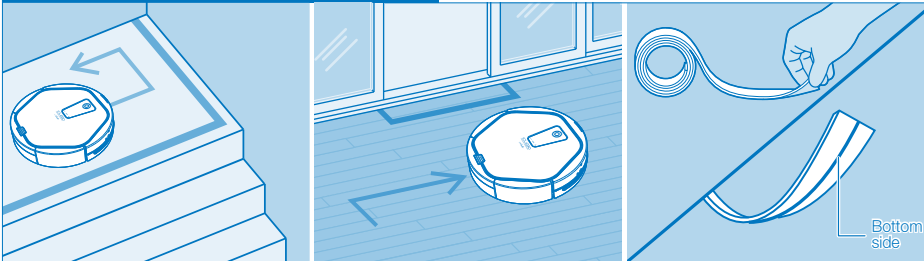

Attach the tape at the top of stairs where there is a danger of falling.

→ If dust accumulates on the fall prevention sensors they may not "see downwards" & not prevent the robot from falling.

Using the robot cleaner

Power On / Off

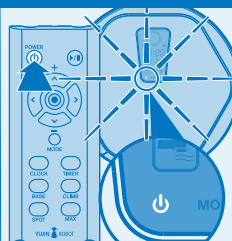

Press power button (⏻).
If you press it one more time,
it is turned off.

Start / Stop cleaning

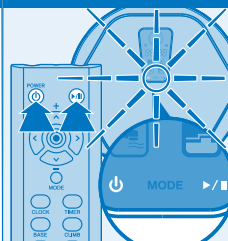

Basic cleaning
: AUTO+ CLIMB

1. Press the power button (⏻).
※ Check if lights come on
AUTO and CLIMB mode
in the display window.
2. Press start button (▶/||).

※ You can click CLIMB button on the remote controller to cancel Climb mode. (If CLIMB mode is off, the robot does not go over doorsills or climb onto the carpet or rugs over 5mm in height.)

※ During the basic cleaning, robot performs the cleaning in vision mapping method, and the robot decides when to finish the cleaning. When the robot decides that the cleaning is finished, it returns to the starting point.

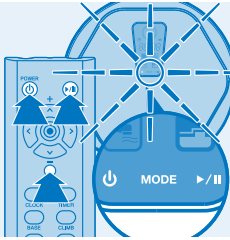

Selected Cleaning
: **RANDOM, SPOT** (blinking)
, **MAX, Wet Mop**

A. RANDOM mode

It cleans with a random method for the time set by the user.

1. Press power button
2. Press MODE button to select RANDOM.
3. Set the cleaning time for robot in the display window. (Default is 60 min. Adjust time with +, - on remote controller.)
4. Check if light comes on RANDOM mode in the display window.
5. Press START button.

B. SPOT mode

It uses AUTO mode to perform focused cleaning within radius 1m area in zigzag mode.

1. Press POWER button.
2. Press SPOT button on the remote controller.
3. Check if AUTO mode is blinking in the display window. Check display AUTO mode blinking (SPOT mode setting is completed.)
4. Press START button.
 - Robot completes the cleaning in SPOT mode and returns to the starting point.

C. MAX mode

It starts the cleaning in AUTO mode, finishes the cleaning in AUTO mode, then changes to RANDOM mode, and cleans until the battery runs out.

1. Press POWER button.
2. Press MAX button on the remote controller.
3. Check if lights come on AUTO mode and RANDOM mode in the display window. (MAX mode setting is completed.)
4. Press START button.
 - Robot cleans until the battery runs out, and returns to the starting point.

D. WET MOP mode

1. Attach wet mop on the robot.
2. Check if light comes on WET MOP button in the display window. Deselecting CLIMB is recommended.

3. Use MODE to select AUTO or RANDOM. (During the setting of RANDOM mode, set cleaning time using +,- button: Default is 60 min.)

※ Spot mode (partial cleaning) and Max mode (until battery runs out) are selected by a separate button on the remote controller.
 ※ In all mode selections, CLIMB is the default value. If you want to turn it off, click CLIMB button on the remote controller to turn off CLIMB mode. (If you turn off CLIMB mode, robot will not go over doorsills or climb on the carpet.)

Using move, charge function

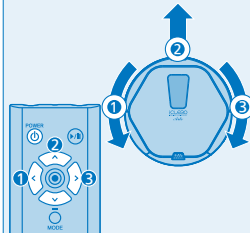

1. Use the direction button of remote control to send the robot cleaner to specific area.

- When backward button is pressed, it turns 180 degree to make the direction change.
- If the direction button is pressed right after pressing power button, it moves without cleaning (suction) function.

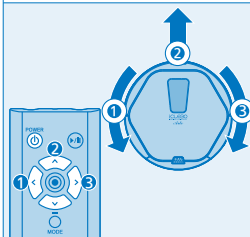

2. After the vacuum cleaning robot started the cleaning, if direction button is pressed, it moves to the desired direction while cleaning.

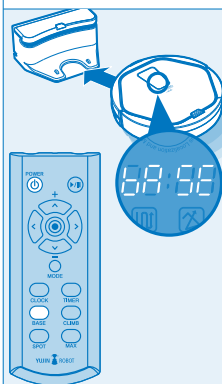

3. If charging (BASE) button of the remote controller is pressed, it finds and moves to the charging station and starts charging.

BASE message is displayed on the display window of the main body, and after returning to the charging station, battery mark blinks.

Cleaning mode



- ※ The default climbing height of obstacles for the robotic vacuum cleaner is up to about 18mm.
- ※ If you wish to set the robot not to go over obstacles over 5mm or doorsill, etc., click CLIMB button to turn off CLIMB mode!
: Please turn off CLIMB mode if you wish to protect carpet, etc.

Set the mode	Cleaning mode	Explanation	Cleaning mode	Explanation
Remote control & cleaning robot	 AUTO	Cleans with camera navigation mapping method	 RANDOM	Randomly cleans during the set time. Set the time with +, - button on remote control
Only with remote control	 SPOT	Zigzag part cleaning within 1m diameter	 MAX	After navigation cleaning, it converts to random mode and cleans until battery runs out

Status	Explanation	Status	Explanation
 Mopping	The cleaning mode is automatically converted to Mopping mode once the mop plate mounted on the bottom	 Door sill adjust	If you press door sill (CLIMB) button of the remote controller, the Performance of the climbing can be increased up to 18mm. (But, there may be differences according to the environment, Such as the structure of the door sill, etc.)

- ※ During the cleaning of carpet or marble floor & patterned tile floors usage of AUTO + CLIMB mode is recommended.

Timer cleaning

- ※ When TIMER is set for cleaning, robot starts the cleaning at the set time everyday.

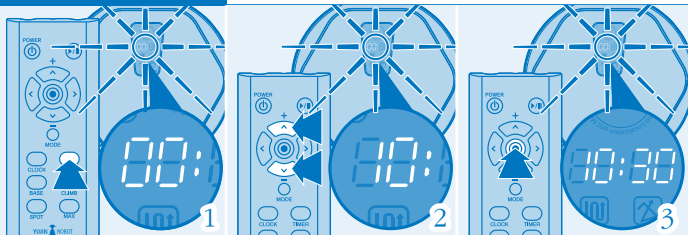

※ Refer to page 10 for setting the current time.

1. Press **Timer button** of the remote control.
→ Time indicator blinks in the display window.
If timer cleaning is set, it displays the set time.
At this time, to set new timer cleaning, press it one more time.
2. Use (+)(-) to set “hour” for timer cleaning and press **Enter button**.
→ The set time is displayed in the display window.
3. Use (+)(-) to set “minute” for timer cleaning and press **Enter button**.
→ The set time is displayed in the display window, and reserved icon (⌚) appears.

- ※ To cancel the reservation, press **timer button** of the remote controller, and press **Enter button** to cancel the reservation.

- ※ When a TIMER cleaning reservation is set in AUTO mode, robot starts cleaning at the set time, completes all the cleaning, and then returns to the charging station.

- ※ When a TIMER cleaning reservation is set in RANDOM mode, robot starts cleaning at the set time everyday, cleans in RANDOM mode for the set min., and returns to the charging station.

Emptying dust bin and servicing the antibacterial filter

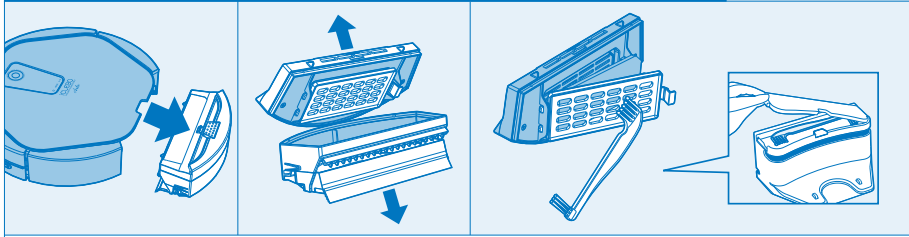

1. Hold the dust bin as in the figure and separate sterilization filter cover.
2. Clean the filter using cleaning brush.

※ **Dust bin can be washed with water.**
However, completely dry them before assembling and using them again.

Cleaning Side Brush

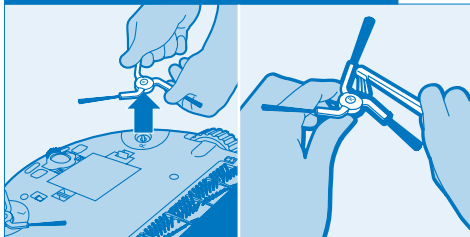

1. Separate the side-brush with both hands.
2. Clean dust and foreign substance using the cleaning brush.

Cleaning Sensor

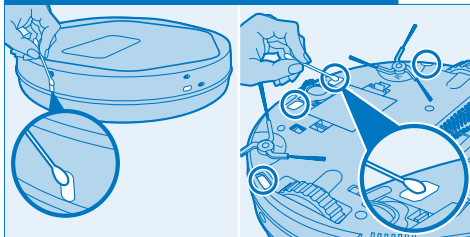

1. Wipe the sensors on the front bumper of the robot cleaner using cotton buds.
2. Wipe the sensors on the bottom of the robot cleaner using cotton buds.

Cleaning Main brush

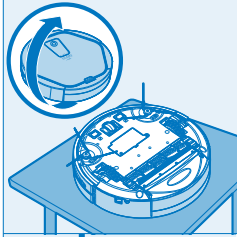
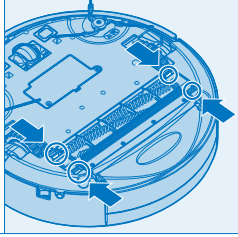
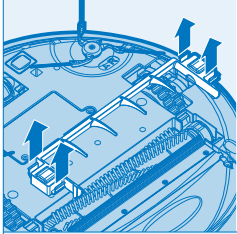
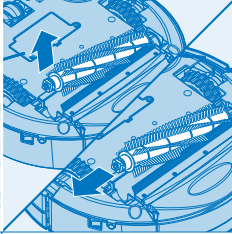
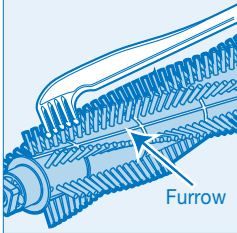
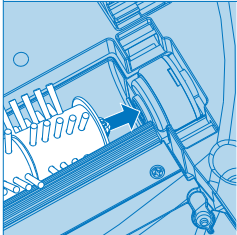
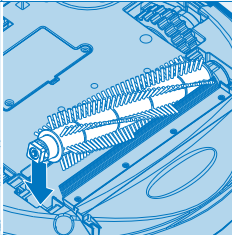
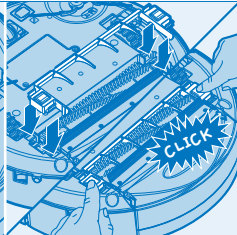
	<ol style="list-style-type: none"> 1. Empty the dust bin first. 2. Turn the robot cleaner over and place the bottom facing upside. 		<ol style="list-style-type: none"> 3. Unlock left/right fixed clip of the main brush.
		<ol style="list-style-type: none"> 4. Separate the brush cover then remove the main brush. 	
 <p>Furrow</p>	<ol style="list-style-type: none"> 5. After each cleaning session, remove hairs or foreign substances stuck on the main brush using the cleaning brush. Over time, hairs and fibres accumulate between the main brush and the bearing. This extra friction makes the cleaning less efficient, wears the battery out faster, gives shorter run times and can eventually block the robot. Pull off the main bearing and remove foreign matter. ※ Use scissors or knife along the main brush furrow to remove the hair easily. 		
			<ol style="list-style-type: none"> 6. After cleaning, put the pyramid-shaped bump on the side of the main brush to the pyramid-shaped recess on the drive cam. (Insert firmly to ensure there is No gap between the brush and the cam.)

Cleaning Front Wheel

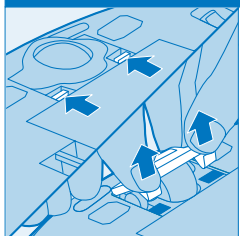
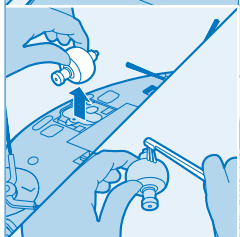
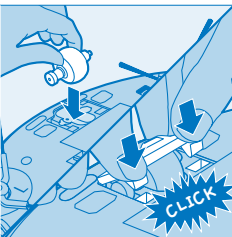
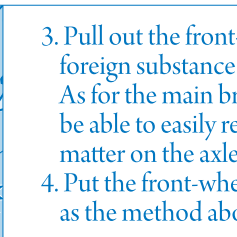
	<ol style="list-style-type: none"> 1. Press the front-wheel fix clip with both hands and lift up to separate. 2. Remove foreign substance on the front brush using the cleaning brush. 		
			<ol style="list-style-type: none"> 3. Pull out the front-wheel then clean dust and foreign substance using the cleaning brush. As for the main brush, remove the bearings to be able to easily remove any hairs or foreign matter on the axle. 4. Put the front-wheel back and re-assemble as the method above.



1. If the vacuum cleaning robot is not used for a long period of time, turn off the power switch on the side of the main body.

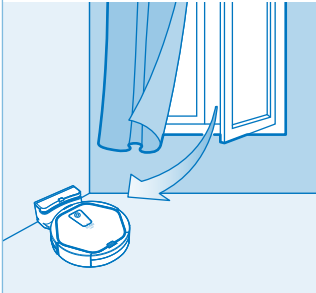

2. Place it where it is cool and ventilated.



Below is the explanation about the most occurred 'breakdowns' when using this product.

If you can't solve the problem with information below, please call your Customer service center.

Problem	Cause	Solution
It is not cleaning well.	<ul style="list-style-type: none"> ▶ Dust bin is full. ▶ Main brush is dirty. ▶ Filter is contaminated. 	<ul style="list-style-type: none"> ▶ See <Product control & maintenance> and empty the dust bin. ▶ See <Product control & maintenance> and use main brush. ▶ See <Product control & maintenance> and clean the dirty filter.
When I press the power button to turn on the robot cleaner, it turns off automatically.	<ul style="list-style-type: none"> ▶ Battery is low. ▶ Battery is enough but the dust bin is full. ▶ Main brush is clogged with hair and dust. 	<ul style="list-style-type: none"> ▶ Charge the robot cleaner. ▶ See <Product control & maintenance> and empty the dust bin. ▶ See <Product control & maintenance> and clean main brush.
The robot cleaner is not responding.	<ul style="list-style-type: none"> ▶ Power switch is turned off. ▶ Battery of remote control is out. ▶ Infrared sensor & beam part of the remote control is blocked or dirty. ▶ Remote control is too close to the charging station. 	<ul style="list-style-type: none"> ▶ Check the power switch on the bottom of the main body. ▶ Re-charge the robot cleaner. ▶ Insert the battery of robot cleaner properly. ▶ Change the battery of the remote control. ▶ Wipe the infrared sensor & beam part of the remote control with soft cloth. ▶ Keep a distance from the charging station and press the button again towards the robot cleaner.
The robot cleaner is not charging.	<ul style="list-style-type: none"> ▶ Charging station or robot cleaner is not connected properly to the plug. 	<ul style="list-style-type: none"> ▶ Connect the power of charging station & robot cleaner properly.
After cleaning, the robot cleaner is not returning to the charging station.	<ul style="list-style-type: none"> ▶ Power of the charging station is not connected properly. ▶ Infrared generator & ejector on the Charging station and detector of the robot cleaner is dirty. ▶ Cleaning was started with auto-mode but not from the charging station. 	<ul style="list-style-type: none"> ▶ Connect the power of the charging station properly. ▶ Move the charging station. No objects must be placed within left/right 19.7 inches, front 5 feet from the Charging station. This is to enable the robot cleaner to return to the charging station automatically after cleaning. ▶ Robot cleaner must start cleaning from the charging station to return to the charging station after cleaning.

<p>Noise of the robot cleaner is getting worse.</p>	<ul style="list-style-type: none"> ▶Dust bin is full or filter is dirty. ▶Main brush is dirty. ▶Main brush is dirty or hairs are accumulating between the main brush and the bearing. 	<ul style="list-style-type: none"> ▶Empty and clean the dust bin. ▶See <Product control & maintenance> (page 13) and clean the filter. ▶See <Product control & maintenance> (page 14) and clean the main brush.
---	--	--

Display error message

Error display	Cause	Solution
C 1	Lifted wheel	Move the robot cleaner to flat area.
C 2	Cannot detect floor	Move the robot cleaner to flat area in case the wheel is stuck on the threshold or porch.
C 3	Dust bin error	Dust bin is not properly assembled. See <Product control & maintenance> and install properly.
C 4	Wheel motor overload	Check if foreign substance such as hair or lint exists on the wheel. See <Product control & maintenance> and remove the foreign substance.
C 5	Brush motor overload	Check if foreign substance such as hair or lint exists on the main brush or side-brush. See <Product control & maintenance> and remove the foreign substance.
C 6	Suction motor overload	See <Product control & maintenance> and clean filter, empty the dust bin.
C 7	Internal system error	Turn off the power switch of the robot cleaner then turn it on again.
C 8	Magnetic Encoder	Check the front wheel & magnetic sensor are clean & correctly inserted

iCLEBO

INTELLIGENT CLEANING ROBOT

Arte

Model Name	iCLEBO POP (YCR-M05-P)
Power	100 V ~ 240 V
Charging Energy Consumption	Below 1.4 W
Main Body Energy Consumption	10 W
Battery	Lithium Ion Battery
Diameter	35 cm
Height	8.9 cm
Weight	2.75 kg
Speed	300 mm/s (Max)
Filter	Antibacterial filter
Sensor	IR, PSD, Encoder, Bumper
Charging Time	110 min.
Usage Time	120 min. (based on normal floor)
Noise	58 dB[A]

iClebo Customer Support : 1.855.926.1601

- **Monday-Friday** 8:30am to 6pm PST
- **Saturdays** 8:30am to 6pm PST
- **Sundays** Closed

MADE IN KOREA

©2014 Yujin Robot Inc.

Cerritos, CA 90703
support@iclebo.com

T 562.926.1601 F 562.926.1629
www.iclebo.com

One-Year Limited Warranty.

Specifications and features are subjected to change without notice.

