

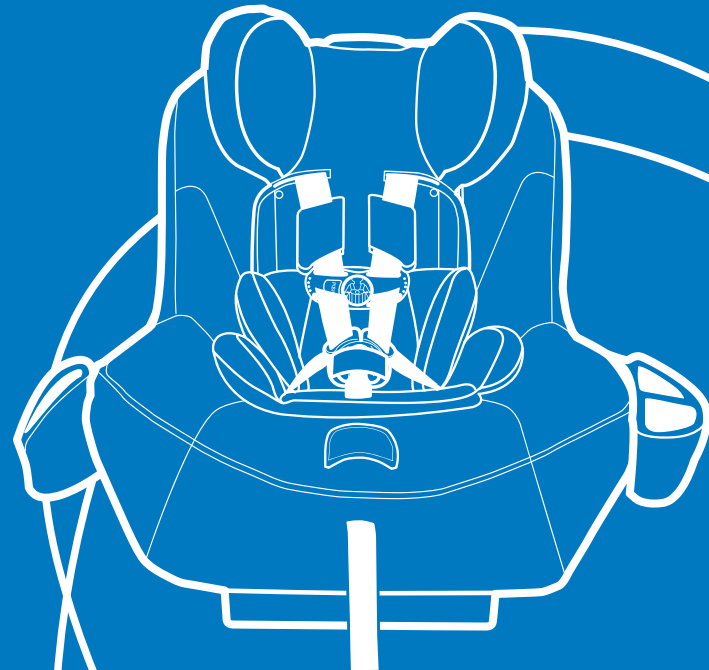

# Vello™ 65

Convertible Car Seat



The Original European Brand  
Synonymous with Safety, Quality & Style

4358-6640



© 2014 Cosco Management Inc. All Rights Reserved.

**KEEP INSTRUCTIONS FOR FUTURE USE.**

Read all instructions before using this child restraint.

**⚠ WARNING:**

**Failure to follow the warnings on the labels and in the instruction manual can result in serious injury or death to your child.**

**A. Before You Begin**.....Pages 3-8

- A-1 Thank You...
- A-2 Registration and Safety Notices
- A-3 Understanding Your Child Restraint

**B. Safety Information**..... Pages 9-10

- B-1 Vehicle Seating Position
- B-2 Installation in Vehicle
- B-3 Child Restraint Use

**C. Basic Use** .....Pages 11-25

- C-1 Choosing Position for Your Child
- C-2 Preparing to Fit Your Child
- C-3 Securing Child in Child Restraint
- C-4 Removing Child From Child Restraint
- C-5 Reclining Child Restraint
- C-6 Removing Seat Pad for Cleaning
- C-7 Installing Seat Pad
- C-8 Accessories on Select Models

**D. General Vehicle Installation** .....Pages 26-30

- D-1 Understanding Your Vehicle
- D-2 Vehicle Seating Position
- D-3 Choosing LATCH or Vehicle Belts
- D-4 Knowing Your Vehicle Belts
- D-5 Aircraft Information

**E. Installing Rear Facing** ..... Pages 31-40

E-1 Preparing to Install Rear Facing

- E-2 Preparing to Install LATCH Rear Facing
- E-3 Installing Rear Facing with LATCH



E-4 Installing Rear Facing with Vehicle Belts



**F. Installing Forward Facing** ..... Pages 41-50

- F-1 Preparing to Install Forward Facing
- F-2 Adjusting Top Anchorage Strap (Tether)

- F-3 Preparing to Install LATCH Forward Facing
- F-4 Installing Forward Facing with LATCH



F-5 Installing Forward Facing with Vehicle Belts



**General Information**..... Pages 51-58

- Using a Locking Clip
- Troubleshooting
- Replacement Parts Order Form
- Warranty

## A-1 Thank You...

Thank you for choosing this car seat, referred to throughout this manual as a child restraint. The DJG family is committed to creating a child restraint with the most comfort and convenience available today.

Remember, parents are a child's first teachers and examples. If you always buckle your seat belt, your child will think it is the natural thing to do. Make it a firm rule that the vehicle does not go until everyone is buckled up. Make no exceptions.

No one can predict if use of a child restraint will prevent injury or death in a particular crash. However, combined with careful driving, proper use of a child restraint can lower a child's risk of injury or death in most crashes.

Your child's safety is worth the time it will take to read and follow these instructions. After reading, if you still have questions or any concerns with this child restraint, please contact our Consumer Relations Department at:

### Maxi-Cosi

Website: [www.maxi-cosi.com](http://www.maxi-cosi.com)  
Fax: 1-800-207-8182  
Mailing Address: Dorel Juvenile Group, Inc.  
P.O. Box 2609  
Columbus, IN 47202-2609  
Telephone: 1-800-951-4113  
8 A.M. to 6 P.M. EST M-TH  
8 A.M. to 4:30 P.M. EST FRI

Para recibir las instrucciones en español, llame al 1-800-544-1108 o solicítase por escrito al dirección por arriba.

## A-2 Registration and Safety Notices

Please complete the postage-paid registration card that came with your child restraint, and send it to us. Child restraints could be recalled for safety reasons. You must register this restraint to be reached in a recall. Send your name, address, email address if available, and the restraint's model number and manufacturing date to:

Dorel Juvenile Group, Inc.  
PO Box 2609, Columbus, IN 47202-2609  
Attn: Consumer Relations

or call 1-800-544-1108 or register online at [www.djgusa.com/registration/carseat/us](http://www.djgusa.com/registration/carseat/us).

For recall information, call the U.S. Government's Vehicle Safety Hotline at 1-888-327-4236 (TTY: 1-800-424-9153), or go to <http://www.NHTSA.gov>

A. Before You Begin

Consumer: Just fill in your name, address and email. Please print (use dark ink).

Your Name \_\_\_\_\_  
Your Street Address \_\_\_\_\_  
City \_\_\_\_\_ State \_\_\_\_\_ Zip \_\_\_\_\_  
Address (optional) \_\_\_\_\_

Model Number	Model Name	Manufacture Date
BC098-BVM	DELUXE HIGHBACK BOOSTER 65	01/22/2014

Model Number (pointing to BC098-BVM)  
Manufacture Date (pointing to 01/22/2014)

Barcode: LW11 B 265035

Example of model number and manufacture date.

If you don't have the card or if your address changes, you will find the model number and manufacture date on the label located on side of shell.



## A-3 Understanding Your Child Restraint

Front View

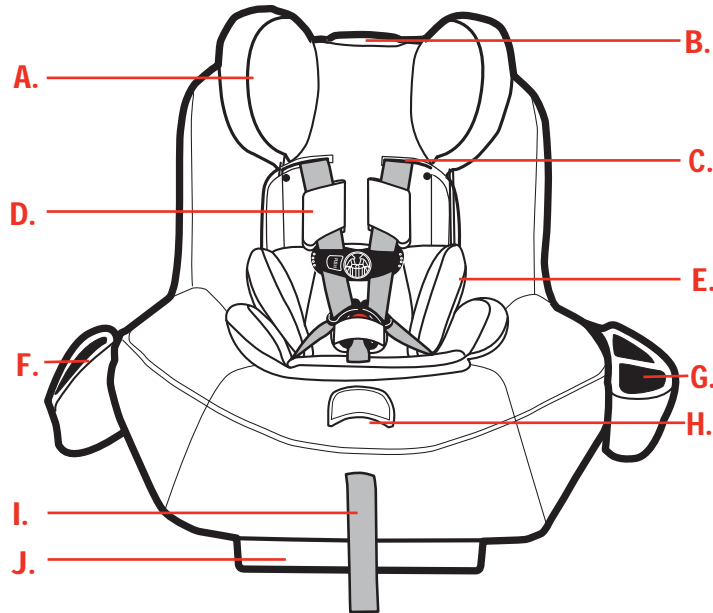

- A. Adjustable Headrest**
- B. Headrest Adjustment Handle**
- C. Headrest Harness Slots**
- D. Harness Covers**  
(on select models)
- E. Body Pillow**  
(on select models)
- F. Removable Cup Holder**
- G. Removable Storage Pockets**
- H. Harness Release Lever**  
(under flap)
- I. Harness Tightening Strap**
- J. Recline Base**

5

Harness System Detail

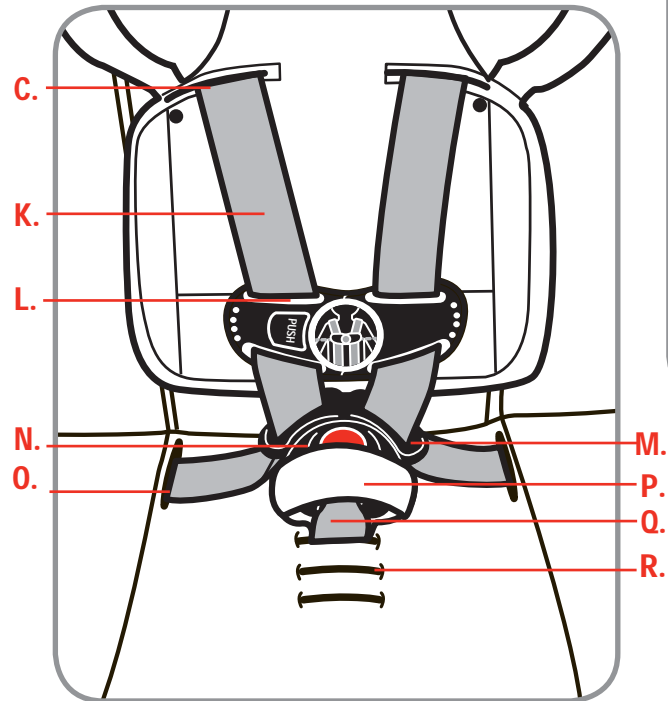

- K. Harness Straps**
- L. Chest Clip**
- M. Buckle Tongue**
- N. Buckle**
- O. Lower Harness Slots**
- P. Buckle Cover**  
(on select models)
- Q. Buckle Strap**
- R. Buckle Strap Slots**

6

*continued on next page.*

A. Before You Begin

Back View

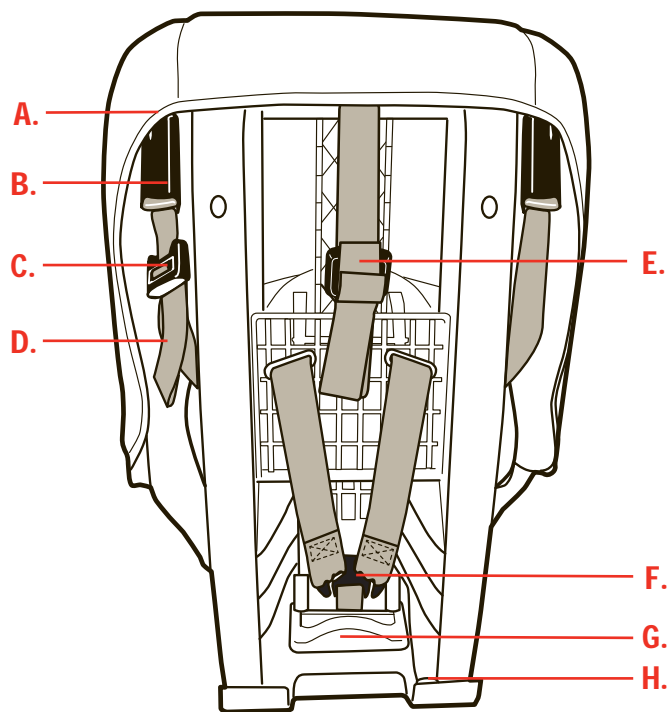

- A.** LATCH Attachment for Storage
- B.** LATCH Connector
- C.** LATCH Adjuster
- D.** LATCH Belt
- E.** Top Anchorage Strap (Tether)
- F.** Splitter Plate
- G.** Seat Recline Handle
- H.** Top Anchorage Strap (Tether) Storage
- I.** Headrest Adjustment Handle

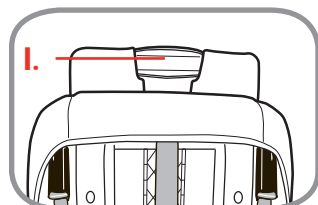

Side View

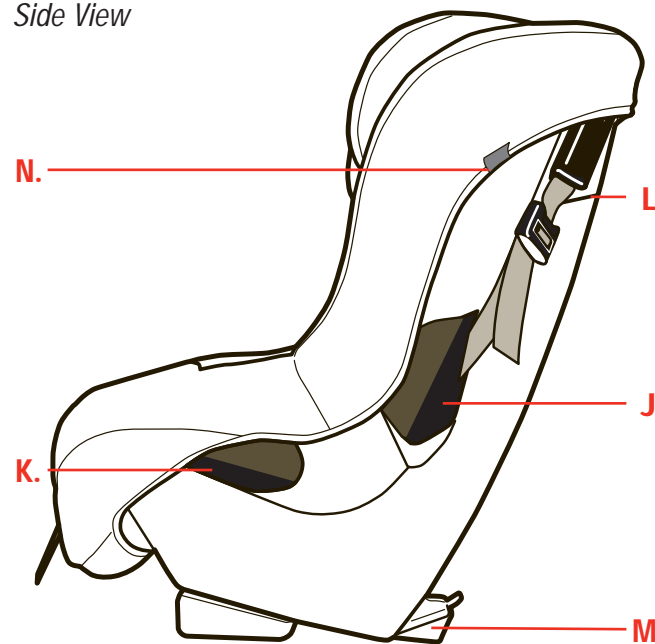

A. Before You Begin

- J.** Forward-Facing Belt Path
- K.** Rear-Facing Belt Path
- L.** Rear Facing Level-to-Ground Line (on side of shell)
- M.** Recline Base
- N.** Instruction Manual Storage (In pocket on side of pad)

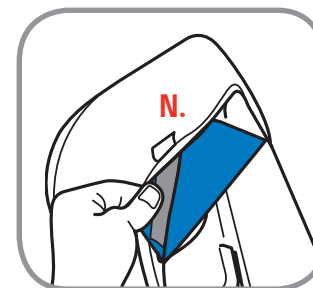

### **⚠ WARNING:**

Failure to follow these warnings can result in the serious injury or death of your child. To help you recognize instructions which are most critical to your child's safety, we use this symbol: ⚠

#### **B-1 Vehicle Seating Position**



⚠ Never place a child rear facing in a seating position with an active frontal airbag.

⚠ Check the vehicle owner's manual for more information about airbag/child restraint use.

⚠ For vehicles without a back seat, refer to your vehicle owner's manual.

#### **B-2 Installation in Vehicle**

⚠ Check the vehicle belt or LATCH belt before each use. Use only if the belt is tightened properly and securely.

⚠ This child restraint should be securely belted in the vehicle even when not in use. In a crash or sudden stop, an unsecured child restraint could injure occupants.

⚠ Do not use a child restraint that has been in a crash. You must get a new child restraint.

#### **B-3 Child Restraint Use**

⚠ Never take your child out of the child restraint while the vehicle is moving.

⚠ Never leave child unattended.

⚠ Placing your child in a hot child restraint may result in burns.

⚠ Do not use a child restraint with damaged or missing parts.

⚠ Do not use cut, frayed or damaged harnesses.

⚠ Do not lubricate buckles and fasteners.

⚠ Do not substitute parts or try to modify the child restraint in any way.

⚠ Do not use any child restraint accessory except those approved by Dorel Juvenile Group.

⚠ Never allow any child to play with this child restraint; it is not a toy.

⚠ Do not remove or cover up any of the warning labels or other labels on the child restraint.

⚠ Read all instructions for additional warnings.

⚠ On the bottom of the base there is an expiration date for use of this child restraint. Do not use this child restraint after the expiration date.

## C-1 Choosing Position for Your Child

Your child's height, weight, and age determine how your child restraint should be placed in the vehicle.



9-40 lb (4-18 kg) and 40 in. (101.6 cm) or less

### Rear Facing using 5-point harness

Child and child restraint are placed in the back seat, facing the back of the vehicle.

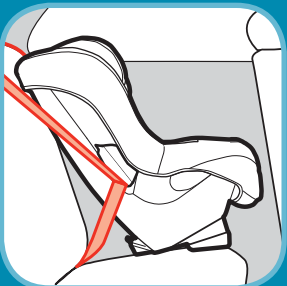

22-40 lb (10.1-18 kg) and 29-43 in. (73.6-110 cm) and at least 1 year old

### Forward Facing reclined using 5-point harness

Child and child restraint are placed in the back seat, facing the front of the vehicle.



40-65 lb (18.1-32 kg) and 43-49 in. (110.1-125 cm) and at least 1 year old

### Forward Facing upright using 5-point harness

Child and child restraint are placed in the back seat, facing the front of the vehicle.

11

## C-2 Preparing to Child Restraint to Fit Your Child

You **MUST** make these adjustments with your child before you install the child restraint in the vehicle.

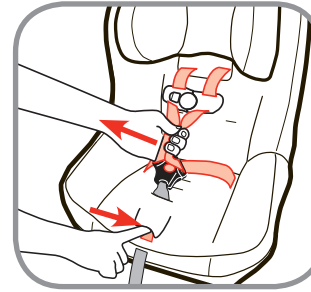

### 1. Loosen Harness

Push down on the harness release lever (under flap on the front of restraint) while pulling out on the harness.



### 2. Release Chest Clip

Press on chest clip release button and pull apart.

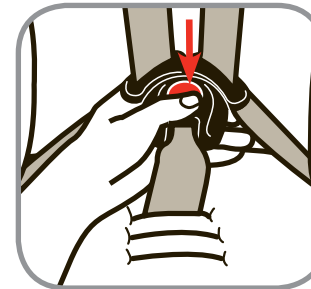

### 3. Unbuckle Harness

Press red button.  
Pull buckle tongues out.  
Place harness straps out of the way.

12

*continued on next page.*

C. Basic Use



#### 4. Place Child in Child Restraint

Place the child's bottom and back flat against the restraint.

This will allow the harness straps to be properly tightened.

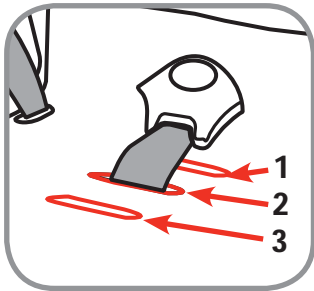

#### 5. Check Buckle Position

Determine which of the three slots is closest to the child.

**When using rear facing: you MUST use the 1st or 2nd buckle strap slots.**

**When forward facing: START in the 1st buckle position and adjust to the 2nd or 3rd position as your child grows.**

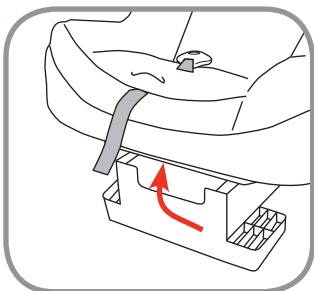

#### 6. To Change Buckle Position

Remove child from child restraint.

Fully recline the child restraint. (See section C-5.) Reach under the seat between base and shell.

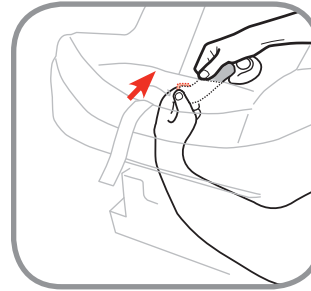

**a.** Locate buckle strap's metal retainer under the shell.

Rotate the metal retainer then insert retainer up through the shell and pad.

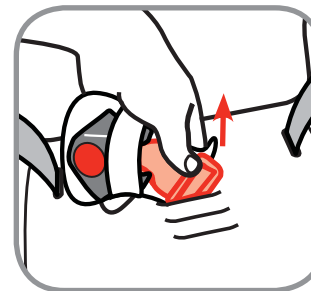

**b.** From the front, pull buckle strap free from shell and pad.

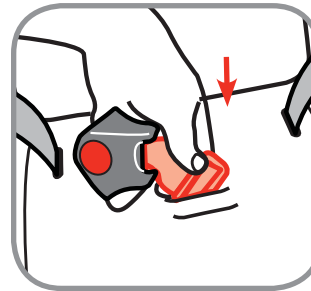

**c.** Insert the buckle's metal retainer through the desired slot.

Make sure that the buckle is **facing out**.

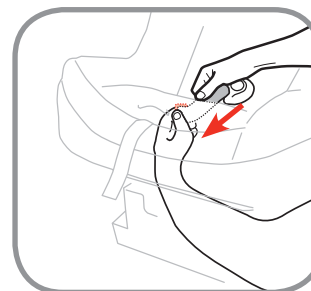

**d.** Reach under seat between base and shell.

Pull metal retainer **completely through pad and shell**.

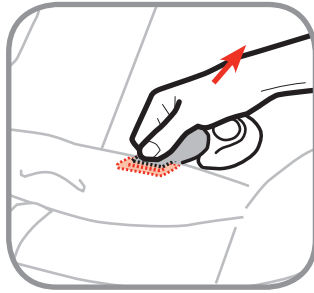

- e. Pull up on buckle strap to make sure it is secured.  
The buckle must not pull out.

**⚠ WARNING:**  
Failure to place buckle's metal retainer completely through pad and shell can result in serious injury or death.



- 7. **Check Harness Height**  
With child in the seat, check the location of the upper harness slot.  
Follow the guidelines below and on next page to determine the correct harness/headrest height.

**Rear-Facing Position**

Upper harness slot must be **even with or just below** the shoulders.

If the upper harness slots are above the child's shoulders with the headrest in the lowest position, **do not** use this child restraint.

**Forward-Facing Position**

Upper harness slots must be **even with or just above** the shoulders.

If the upper harness slots are below the child's shoulders with the headrest in the highest position, **do not** use this child restraint.

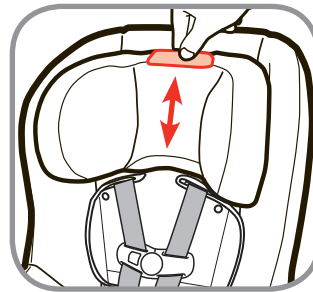

- 8. **To Adjust Harness/Headrest Height**  
Loosen harness straps.  
Squeeze the headrest adjustment handle and move headrest up or down to the proper height and lock into place.

**⚠ WARNING:**

 Do not use this child restraint rear facing if the top of your child's head is above the top of the child restraint's headrest.

 Do not use this child restraint forward facing if the midpoint of your child's head is above the top of the child restraint's headrest.

**Make sure the harness height is correct for your child's size.**

**Failure to follow these steps can result in serious injury or death.**

## C-3 Securing Child in Child Restraint



- 1. Position Harness Straps Over the Child's Shoulders**

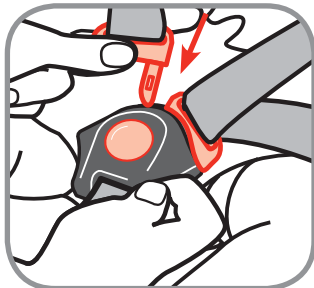

- 2. Buckle Harness**  
Push each buckle tongue into buckle until you hear a "click."  
Pull up on harness straps to make sure buckle is locked.

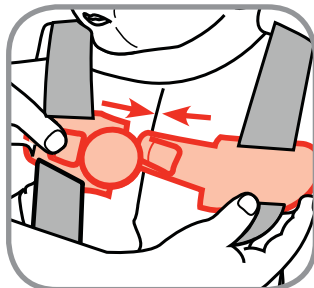

- 3. Close Chest Clip**  
Insert right half of chest clip into left half and snap together.

17

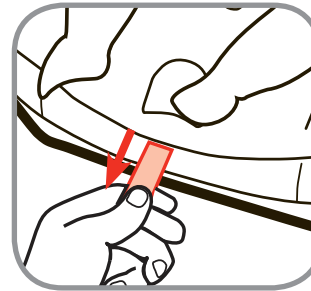

- 4. Tighten Harness**

Pull on harness tightening strap to tighten harness snugly.

**NOTE:** A snug strap should not allow any slack. It lies in a relatively straight line without sagging. It

does not press on the child's flesh or push the child's body into an unnatural position.



- 5. Check Harness Tightness**

Try to pinch the harness at the shoulders.

If you can pinch the harness strap, tighten more.

If your fingers slip off, the harness is tight enough.



- 6. Position Chest Clip**

The chest clip must be placed at mid-chest (even with armpits) and away from the child's neck.

### **⚠ WARNING:**

Failure to fasten and tighten the harness system correctly and snugly can result in serious injury or death.

18

## C-4 Removing Child From Child Restraint

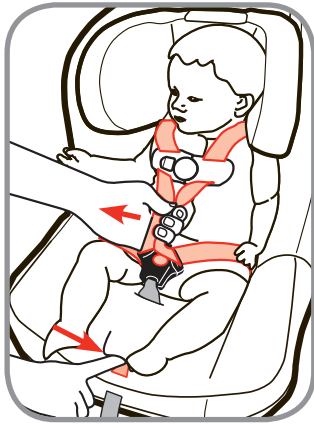

### 1. Loosen Harness

Push down on the harness release lever (under flap on the front of restraint) while pulling out on the harness.

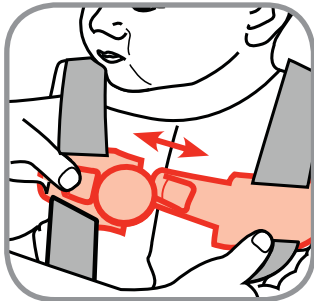

### 2. Release Chest Clip

Press on release button and pull apart.

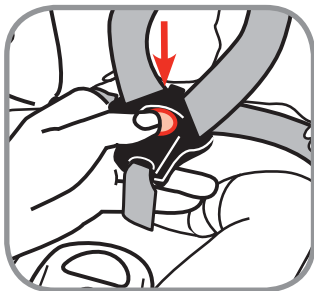

### 3. Unbuckle Harness

Press red button.  
Pull buckle tongues out.  
Place harness straps out of the way.

19

## C-5 Reclining Child Restraint

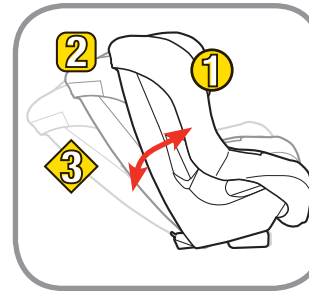

This child restraint has 3 recline positions:

**Rear Facing** - Use angle position **2** or **3**.

The level-to-ground line on the side of shell **MUST** be level with the ground.

**Forward Facing** -

22-40 lb (10.1-18 kg)  
29-43 in. (73.6-110 cm)  
**MUST** use angle position **2**.

40-65 lb (18.1-29 kg)  
43-49 in. (110.1-125 cm)  
**MUST** use angle position **1**.

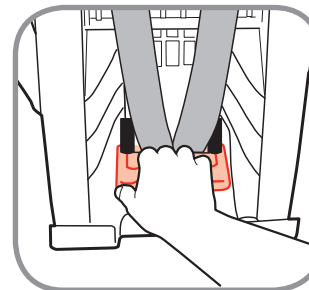
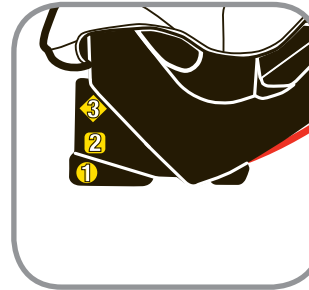

**To Recline**

Pull out on handle to correct angle position.

C. Basic Use

20

## C-6 Removing Seat Pad for Cleaning

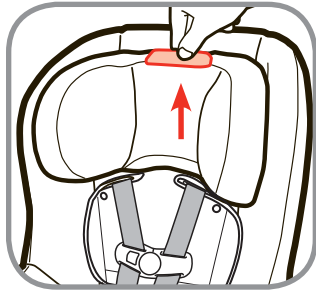

1. **Place Headrest In Highest Position**

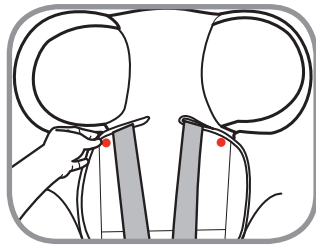

2. **Remove Headrest Pad**  
Undo headrest pad fasteners and gently pull pad around the harness straps and off of headrest.

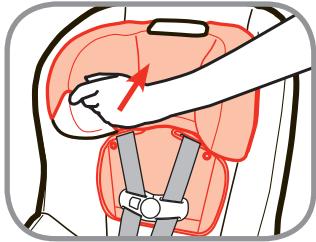

3. **Undo Fasteners on Seat Pad**

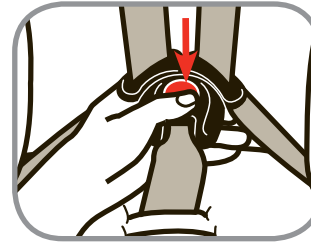
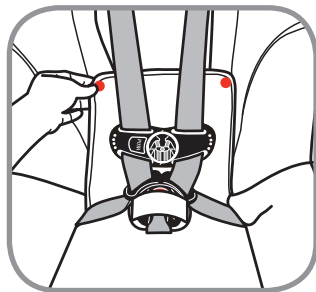

4. **Unbuckle Harness**  
Press red button. Pull buckle tongues out.

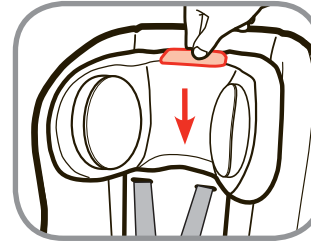

5. **Lower Headrest to Lowest Position**

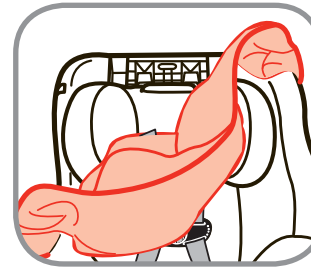

6. **Remove Seat Pad**  
Pull the pad off the outside edges of the shell then around the headrest.  
Pull buckle through slot in pad.

### Cleaning Seat Pad

The seat and headrest pads are washer and dryer safe using cold water and a gentle cycle. Harness covers must be washed and dried separately using cold water and a gentle cycle. Make sure harness covers are securely fastened when placing into washer and dryer. Spot clean the harness straps. Do not use bleach or other harsh cleaners. Do not dry clean.

### **WARNING:**

**Do not use child restraint without the seat pad. Failure to do this can result in serious injury or death.**

## C-7 Installing Seat Pad

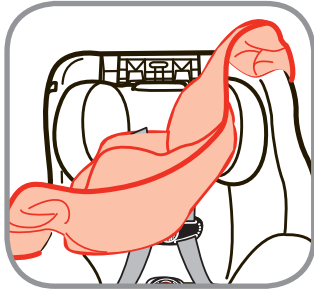

### 1. Slip Seat Pad Over and Behind Headrest

Lay pad in child restraint and slip pad over and behind the headrest.

Pull buckle through slot in pad.

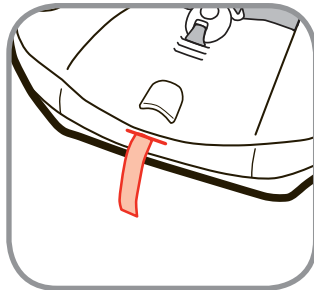

### 2. Pull Harness Tightening Strap Through Slot in Pad

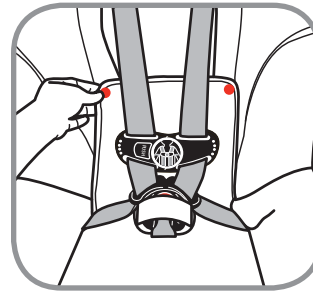

### 4. Attach Fasteners on Seat Pad

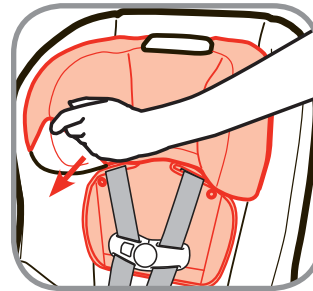

### 5. Gently Pull Headrest Pad onto Headrest

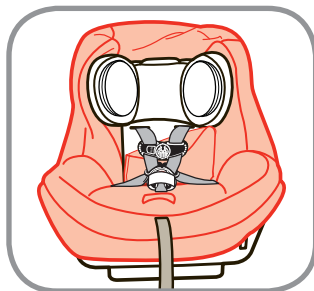

### 3. Pull Pad Over the Outside Edges of the Shell

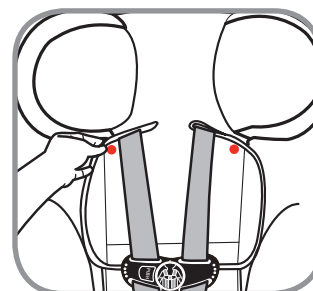

### 6. Attach Fasteners on Headrest Pad

C. Basic Use

23

24

## C-8 Accessories on Select Models

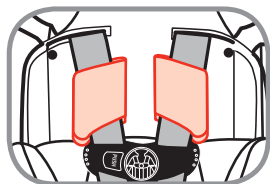

### Harness Covers

Harness covers help provide comfort to the neck. For smaller infants, you may need to fit the upper end of the harness covers into the harness slots.

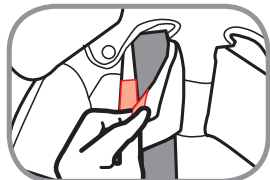

To remove, you will have to undo the fastening strips and pull them off the harness strap.

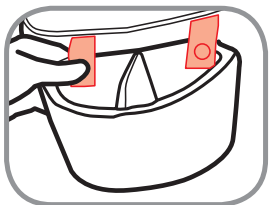

### Storage Pockets

The storage pockets can go on either side of seat.

To attach the storage pockets, line both of the fasteners on side of seat up with fasteners on storage pockets.

Press fasteners together.

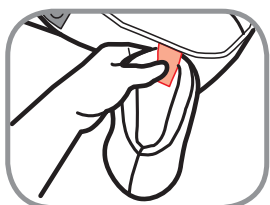

### Cup Holder

The cup holder can go on either side of seat.

To attach the cup holder, line one of the fasteners on side of seat up with fastener on cup holder.

Press fasteners together.

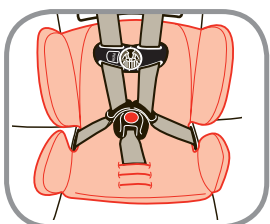

### Body Pillow

The body pillow adds extra comfort to your child. As your child grows, remove the pillow. Pull buckle through slot in pillow and remove pillow.

25

## D-1 Understanding Your Vehicle

Your vehicle's features may be considerably different than those pictured here. Consult your vehicle owner's manual to help identify your vehicle's specific features and locations.

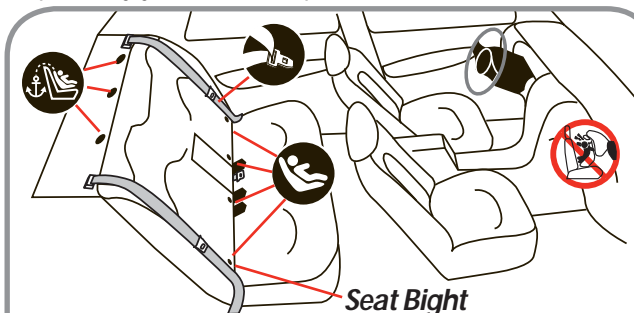

### Anchor Brackets

For Top Anchorage Strap (Tether)  
(Forward Facing Only)



### LATCH Anchors

Located in the seat bight.



### Airbags

Consult your vehicle owner's manual for all airbag locations.



### Vehicle Seat Belts

Consult your vehicle owner's manual for vehicle belt use.

## Safety Tip:

**To avoid your child being seriously burned, take the following precautions:**

1. Park in the shade or where sun does not directly hit the child restraint.
2. Cover the child restraint with a sheet or blanket when not in use.
3. Check for hot seat and buckles before placing child in child restraint.

To help protect your vehicle seat's upholstery from damage, use a single layered towel underneath and behind child restraint.

26

D. General Vehicle Installation

## D-2 Vehicle Seating Position

Some seating positions in your vehicle may not be safe for this child restraint. Some vehicles do not have a seating position that can be used safely with this child restraint. If you are not sure where to place the child restraint in your vehicle, consult your vehicle owner's manual or contact Dorel Juvenile Group Consumer Relations Department.

### **⚠ WARNING:**



**Never place a child rear facing in a seating position with an active frontal airbag. This can result in serious injury or death.**



**Use the child restraint only on vehicle seats that face forward. Do not use on seats that face the sides or rear of the vehicle.**

### **Safety Tip:**



**Children are safer when properly restrained in rear seating positions than in the front seating positions.**

**According to National Highway Traffic Safety Administration information, children in rear seating positions are statistically safer, whether you have airbags, advanced airbags, or no airbags at all.**

27

## D-3 Choosing LATCH or Vehicle Belts

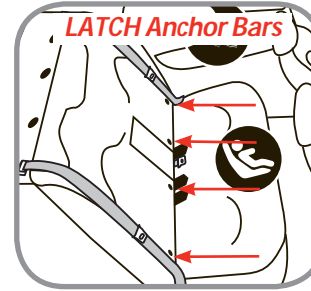

### **The LATCH System**

LATCH (Lower Anchors and Tethers for CHildren) is a universal system for installing child restraints without using vehicle seat belts.

The LATCH system can **ONLY** be used in vehicles that have the LATCH anchor bars installed and designated LATCH seating positions. Most vehicles manufactured after September 2002 are equipped with LATCH.

Check your vehicle owner's manual to see which seating positions may be equipped with the LATCH system.

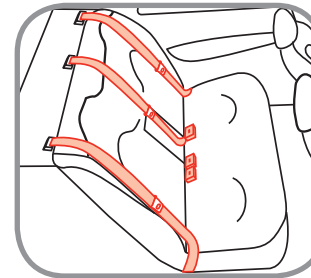

### **Vehicle Belts**

If LATCH is not an option, you must use the vehicle seat belt system to install the child restraint. There are some vehicle belts that will not work with a child restraint or will require special

attention. See next page and check your vehicle owner's manual for specific instructions.

### **⚠ WARNING:**

**Do not use both the LATCH belt and vehicle belt at the same time.**

28

## D-4 Knowing Your Vehicle Belts

Review your vehicle owner's manual for vehicle seat belt use with child restraints. This is your best source for information concerning your vehicle.

Not all vehicle belts will work with this child restraint. This child restraint must be tightly locked in place at all times, during travel. You must determine if your vehicles belts are compatible with this child restraint.

### Vehicle Belts

#### • **Automatic/Passive vehicle seat belts**

You **MUST** have a vehicle lap belt to install any child restraint. An automatic (passive) shoulder vehicle belt may or may not have a separate vehicle lap belt. Consult your vehicle owner's manual.



#### • **Vehicle belts in center of the door or side panel**

You must move the child restraint to another seating location. Consult your vehicle owner's manual.

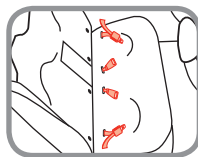

#### • **Vehicle belts that are in front of the seat bight**

You may need to move the child restraint to another seating location. Consult your vehicle owner's manual.

#### • **Do Not Use with inflatable seat belts**

You may need to move the child restraint to another seating location or use LATCH belts only.

#### • **ELR (Emergency Locking Retractor) vehicle belts**

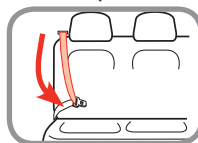

These lap and shoulder vehicle belts only lock in a sudden stop or crash, and do not properly secure a child restraint alone. Consult your vehicle owner's manual.

To learn if you have this type of vehicle belt, gently pull the vehicle belt all the way out of the retractor (spool), let it return several inches, then pull on it again. If it moves freely, it is an ELR vehicle belt.

If it is locked and will not allow any more vehicle belt to come out, it is a switchable retractor.

29

## ⚠ **WARNING:**

**ELR lap-only vehicle belts MUST NOT be used with this child restraint.**

#### • **Switchable retractor**

These vehicle belts switch from ELR to ALR (Automatic Locking Retractor). You must have the vehicle belts in the locking mode to use them. Follow the instructions in the installation sections.

#### • **ALR (Automatic Locking Retractor)**

These vehicle belts lock after pulling the webbing out and letting the vehicle belt go back into the retractor an inch or two. Follow the instructions in the installation sections.

### Vehicle Latch Plates

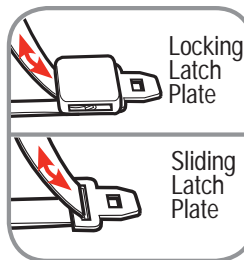

#### • **Check the Latch Plates**

Grasp the tongue portion of the latch plate (the part that goes inside the buckle) and pull straight out, in line with the vehicle lap belt. If the latch plate does not slide up and down the vehicle belt, you have a locking latch plate. You should not need to use a locking clip. Consult your vehicle owner's manual.

If the latch plate slides up and down on the vehicle belt, and you have an ELR retractor, you **MUST** use a locking clip to install the child restraint. You may not need to use the locking clip with a switchable or ALR retractor. Consult your vehicle owner's manual.

## D-5 Aircraft Information



This restraint is certified for aircraft use.

Use only on forward-facing aircraft seats. Follow instructions for vehicle installation.

Contact the airline for their specific policies.

30

## E-1 Preparing to Install Rear Facing

9-40 lb (4-18 kg) and 40 in. (101.6 cm) or less in height

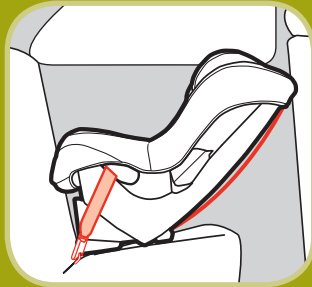

 LATCH Belt

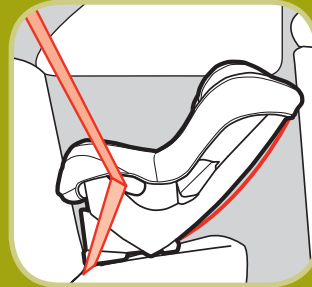

 Lap/Shoulder Belt



 Lap Belt

**⚠ WARNING:**

 Never place a child rear facing in a seating position with an active frontal airbag. This can result in serious injury or death.

This child restraint must always face the rear of the vehicle and reclined when the child is less than one year old.

## E-2 Preparing to Install LATCH Rear Facing

**NOTE:** You may need to raise the headrest to pull the LATCH belt out.

Recheck the headrest harness height when you place your child into the seat.

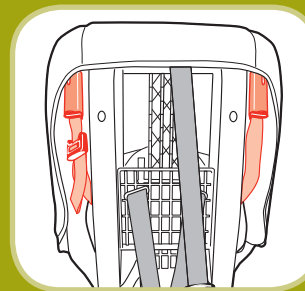

### 1. Remove LATCH Belt from Storage

Push in the the red buttons on the LATCH connectors to disconnect and pull the LATCH belt out of the forward-facing belt path.

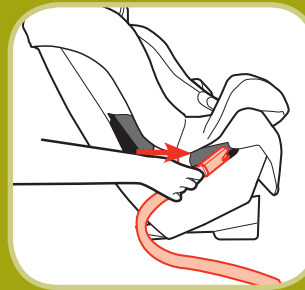

### 2. Routing LATCH Belt

Insert the connector **without** adjuster through the rear-facing belt path.

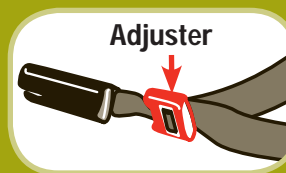

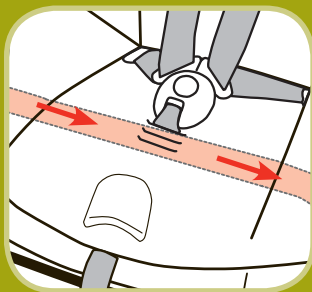

### 3. Pull Connector Across to Opposite Side

Reach under pad and pull the LATCH connector across the shell in front of buckle strap and out opposite side.

**Do not place belt over child's legs.**

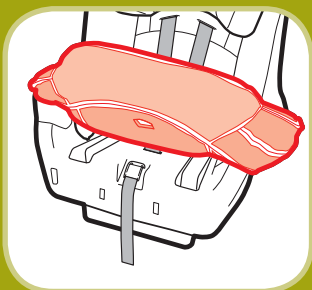

**Tip:** You may need to pull the pad off the front corners of plastic shell to help thread the LATCH belt across the shell.

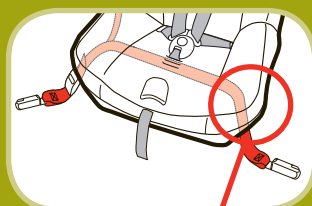

### 4. Make sure the LATCH Belt is Not Twisted

Replace the pad on the corners of shell if needed.

**NOTE:** The LATCH belt **MUST** be threaded into the belt positioning guide as shown on both sides of shell.

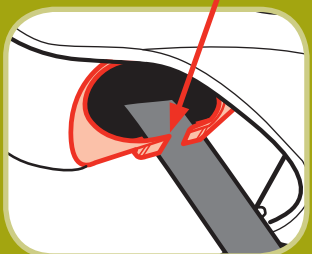

## E-3 Installing Rear Facing with LATCH

**NOTE:** Review your vehicle owner's manual for LATCH belt use.

### **WARNING:**

**Do not use LATCH along with the vehicle lap or lap/shoulder belt.**

**Check LATCH belt before each use. Use only if the belt can be tightened properly and securely.**

**Store the tether hook to the base when used rear facing.**

**Failure to follow these warnings can result in serious injury or death.**

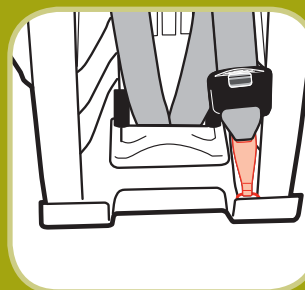

### 1. Store Tether

Attach the tether hook to the bottom of the base as shown. Gently tighten to remove slack.

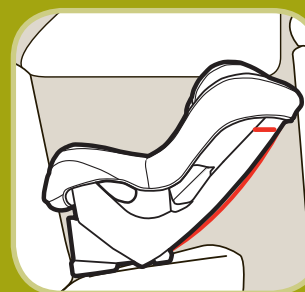

### 2. Place Child Restraint in the Back Seat Rear Facing

Move the front seats forward to give you room to install the child restraint.

With the child restraint in a reclined position, center the child restraint in the chosen seating position.



### 3. Check for Proper Recline

Make sure level-to-ground line on side of shell is level with ground. Adjust child restraint if needed.

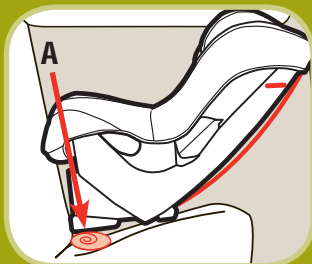

You may need to place a rolled towel(s) or foam pool noodle(s) (**A**) under the front of the child restraint to allow the level line on the side of the plastic shell to be level with the ground. Check often to be sure padding is still in place and the LATCH belt is tight.

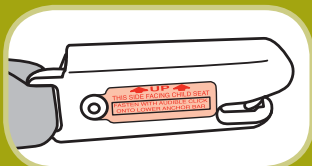

### 4. Connect LATCH to Vehicle LATCH Anchor

**NOTE:** The LATCH's red release button **MUST** face away from child restraint and the arrows on connectors **MUST** face up.

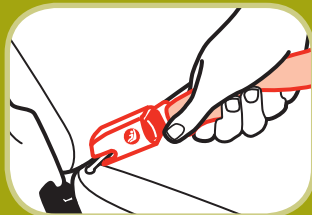

Fasten one LATCH belt connector to the anchor in the vehicle seat located in the vehicle seat bight. Repeat for other side of child restraint.

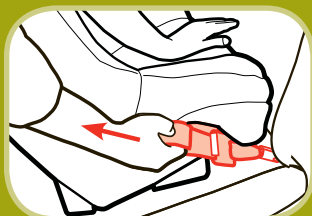

### 5. Tighten Belt

Place hand in child restraint and firmly push down and towards the vehicle seat back while pulling up on the free end of belt to tighten.

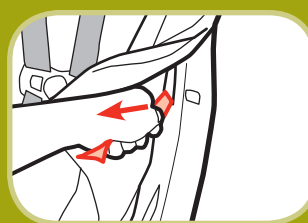

It may be easier to tighten the belt through the belt path opening as shown.

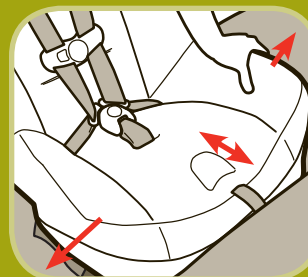

### 6. Check Belt Tightness

Grasp the child restraint **at the belt path with one hand**. Push and pull the child restraint from side to side, forward and back. The child restraint should not move more than 1 in. (2.5 cm).

**NOTE:** If it moves more than 1 in. (2.5 cm), try reinstalling the child restraint or try another seating location.

**Secure child in child restraint.**

**Recheck the recline angle. Repeat steps if not reclined correctly.**

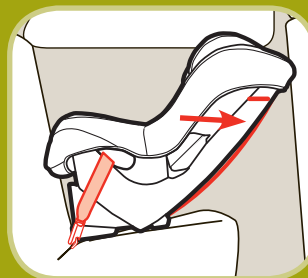

### To Remove LATCH Belt From Vehicle Anchor

Remove child from child restraint.

Press down firmly on child restraint and press the red release button on each connector.



## E-4 Installing Rear Facing with Vehicle Belts

**NOTE:** Review section D-4 to determine what kind of vehicle belts you have. Review your vehicle owner's manual for vehicle seat belt use.

### **⚠ WARNING:**

**Do not use LATCH along with the vehicle lap or lap/shoulder belt. Store LATCH belts when using the vehicle belts.**

**Check the vehicle belt before each use. Use only if the belt is tightened properly and securely.**

**Store the tether hook to the base when used rear facing.**

**Failure to follow these warnings can result in serious injury or death.**

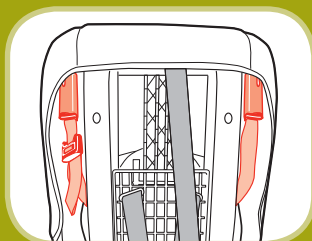

### 1. Store LATCH

Thread LATCH belt through **forward facing** belt path in order to attach the connectors to LATCH attachments.

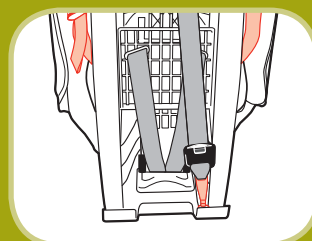

### 2. Store Tether

Attach the tether hook to the bottom of the base as shown. Gently tighten to remove slack.

37



### 3. Place Child Restraint in the Back Seat Rear Facing

Move the front seats forward to give you room to install the child restraint.

With the child restraint in a reclined position, center the child restraint in the chosen seating position.



### 4. Check for Proper Recline

Make sure level-to-ground line on side of shell is level with ground. Adjust child restraint if needed.

You may need to place a rolled towel(s) or foam pool noodle(s) **(A)** under the front of the child restraint to allow the level line on the side of the plastic shell to be level with the ground. Check often to be sure padding is still in place and the vehicle belt is tight.

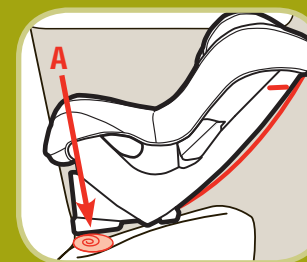

38

*continued on next page.*

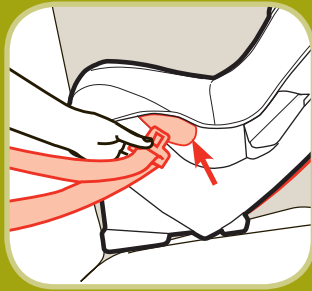

**5. Thread Vehicle Belt**

Thread the vehicle lap or lap/shoulder belt combination through the rear-facing belt path.

With an ALR vehicle belt, pull the vehicle belt all the way out before threading the child restraint.

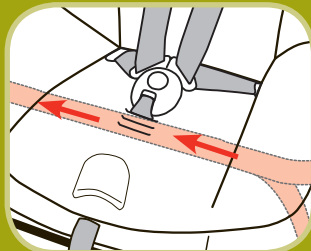

**6. Pull Latch Plate Across to Opposite Side**

Reach under pad and pull the vehicle belt across the shell in front of buckle strap and out opposite side.

**Do not place vehicle belt over child's legs.**

Buckle vehicle belt.

**NOTE:** The vehicle lap belt **MUST** be threaded into the belt positioning guide as shown on both sides of shell.

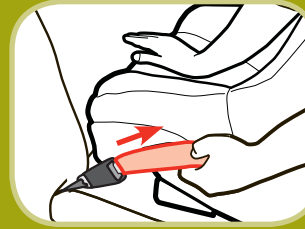
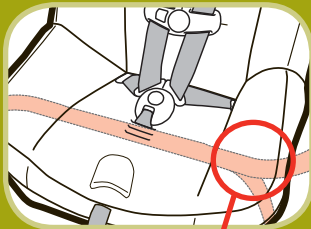

**7. Tighten Belt**

Place hand in child restraint and firmly push down and towards the vehicle seat back while pulling up on the shoulder belt or lap belt to tighten.

It may be easier to tighten the belt through the belt path opening as shown.

With a switchable retractor, pull the shoulder belt all the way out to switch the retractor into the ALR mode before tightening. Feed the slack back into the retractor while tightening.

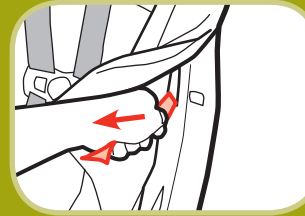

way out to switch the retractor into the ALR mode before tightening. Feed the slack back into the retractor while tightening.

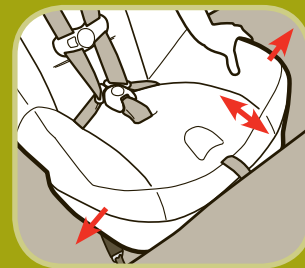

**8. Check Belt Tightness**

Grasp the child restraint **at the belt path with one hand**. Push and pull the child restraint from side to side, forward and back. The child restraint should not move more than 1 in. (2.5 cm).

**NOTE:** If it moves more than 1 in. (2.5 cm), try reinstalling the child restraint or try another seating location.

**Secure child in child restraint.**

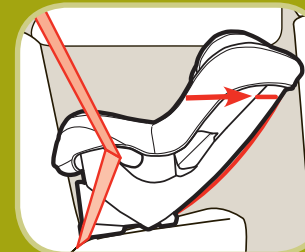

Recheck the recline angle. Repeat steps if not reclined correctly.

## F-1 Preparing to Install Forward Facing

### Safety Tip:

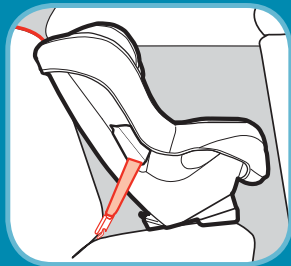

Experts agree that children should remain rear facing as long as possible. In this child restraint, your child can remain rear facing up to 40 lb (18 kg) and up to 40 in. (101.6 cm).

22-40 lb (10.1-18 kg) and 29-43 in. (73.6-110 cm) and at least 1 year old.

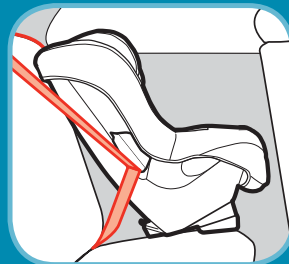

 LATCH Belt with tether  
 up to 40 lb (18 kg)



 Lap/Shoulder Belt with tether  
 up to 40 lb (18 kg)

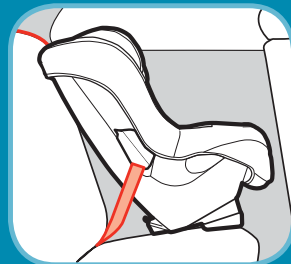



  Lap Belt with tether up to 40 lb (18 kg)

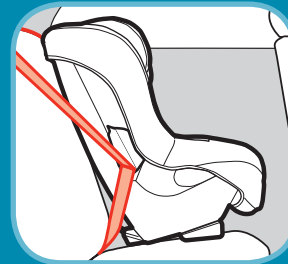

**2** Recline Position

40-65 lb (18.1-29 kg) and 43-49 in. (110.1-125 cm) and at least 1 year old.



 Lap/Shoulder Belt with tether up to 65 lb (29 kg)  

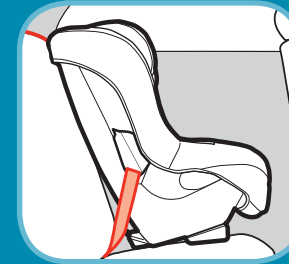

 Lap Belt with tether up to 65 lb (29 kg)  



**1** Recline Position

### ⚠ WARNING:

Never place a child less than 1 year old or weighing less than 22 lb (10.1 kg) forward facing.

F. Installing Forward Facing



## F-2 Adjusting Top Anchorage Strap (Tether)

The tether is used for the forward-facing position only.

**NOTE:** We strongly recommend that you use the tether in the forward-facing position. If your vehicle does not have an anchor bracket, please see your dealer or a qualified mechanic and have one installed. The tether can greatly improve the performance of this child restraint.

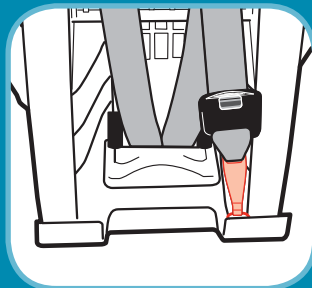

### Storage of Top Anchorage Strap (tether):

When the tether is not in use, attach the tether hook to the bottom of the base as shown. Gently tighten to remove slack.

### To Adjust Top Anchorage Strap (Tether):



Pull free end to tighten

**To tighten:** After the child restraint is locked into place with LATCH or vehicle belt, push down on child restraint and gently pull on free end of tether.

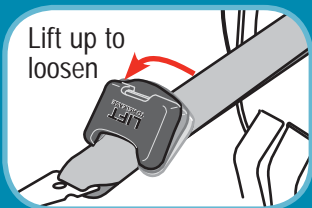

Lift up to loosen

**To loosen:** Lift up on top anchorage lock and push lock adjuster toward tether hook.

43



## F-3 Preparing to Install LATCH Forward Facing



### ⚠ WARNING:

**Do not use the lower anchorage system (LATCH system) to attach this child restraint when restraining a child weighing more than 40 lbs (18 kg) with the internal harnesses of the child restraint.**

**NOTE:** Pull the LATCH belt out of the rear-facing belt path if you have used this child restraint rear facing.

You may need to raise the headrest to pull the LATCH belt out. Recheck the headrest harness height when you place your child into the seat.

### 1. Routing LATCH Belt

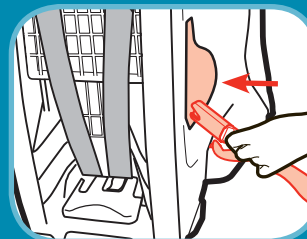

Insert the connector **with** the adjuster closest to it through the forward-facing belt path.

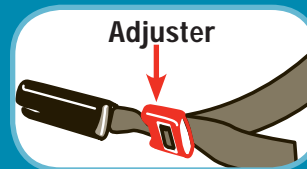

Adjuster

### 2. Thread LATCH Across

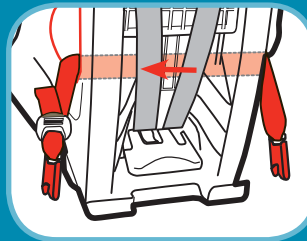

Pull the LATCH connector across the back and out the other side as shown.

Make sure the belt is not twisted.

44



## F-4 Installing Forward Facing with LATCH



**NOTE:** Review your vehicle owner's manual for LATCH belt use.

### **⚠ WARNING:**

Do not use LATCH along with the vehicle belt. Check LATCH belt before each use. Use only if the belt is tightened properly and securely. Failure to follow these warnings can result in serious injury or death.



22-40 lb (10.1-18 kg)

### 1. *Place Child Restraint in the Back Seat Forward Facing*

Place the child restraint flat on vehicle seat bench and slide the child restraint back until it pushes against the vehicle seat back.

### Installation Tip:

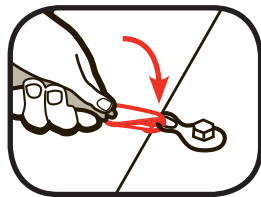

Loosely attach the tether hook before attaching the LATCH belt. Consult vehicle owner's manual for specific location.

45

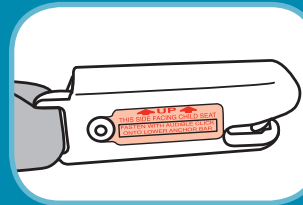

### 2. *Connect LATCH to Vehicle LATCH Anchor*

**NOTE:** The LATCH's red release button **MUST** face away from child restraint and the arrows on connectors **MUST** face up.

Fasten one LATCH belt connector to the anchor in the vehicle seat located in the vehicle seat bight.

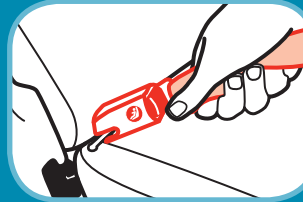

Repeat for other side of child restraint.

### 3. *Tighten Belt*

Place hand in child restraint and firmly push down and towards the vehicle seat back while pulling up on the free end of belt to tighten.

It may be easier to tighten the belt through the belt path opening as shown.

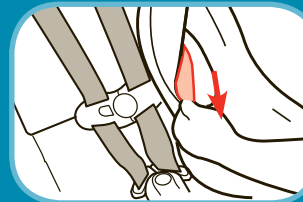
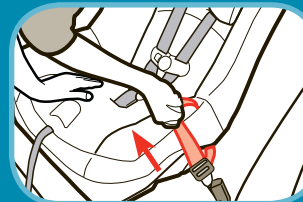

### 4. *Tighten Tether*

Push firmly on the back of the seat and tether strap.

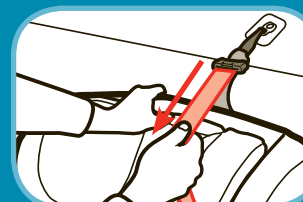

46

*continued on next page.*

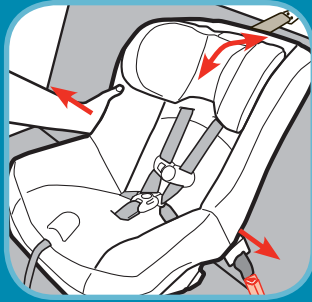

### 5. Check Belt Tightness

Grasp the child restraint **at the belt path with one hand**. Push and pull the child restraint from side to side, forward and back. The child restraint should not move more than 1 in. (2.5 cm).

**NOTE:** If it moves more than 1 in. (2.5 cm), try reinstalling the child restraint or try another seating location.

**Secure child in child restraint.**



### To Remove LATCH Belt From Vehicle Anchor

Remove child from child restraint.

Press down firmly on child restraint and press the red release button on each connector.



## F-5 Installing Forward Facing with Vehicle Belts



**NOTE:** Review section D-4 and your vehicle owner's manual to determine what kind of vehicle belts you have.

### **WARNING:**

**Do not use LATCH along with the vehicle belt. Store LATCH belts when using the vehicle belts.**

**Check the vehicle belt before each use. Use only if the belt is tightened properly and securely.**

**Failure to follow these warnings can result in serious injury or death.**

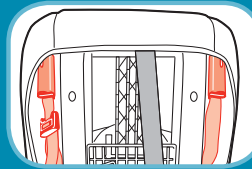

### 1. Store LATCH



### 2. Place Child Restraint in the Back Seat Forward Facing

Place the child restraint flat on vehicle seat bench and slide the child restraint back until it pushes against the vehicle seat back.

22-40 lb (10.1-18 kg)



40-65 lb (18.1-29 kg)

## Installation Tip:

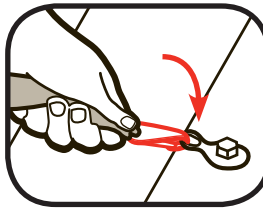

Loosely attach the tether hook before threading the vehicle belt. Consult vehicle owner's manual for specific location.

### 3. Thread Vehicle Belt

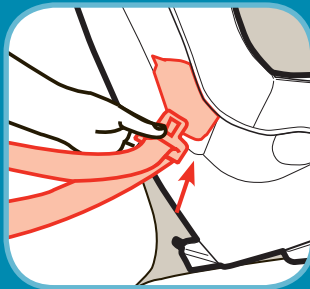

Thread the vehicle lap or lap/shoulder belt combination through the forward-facing belt path and out the other side. Buckle vehicle belt.

### 4. Tighten Belt

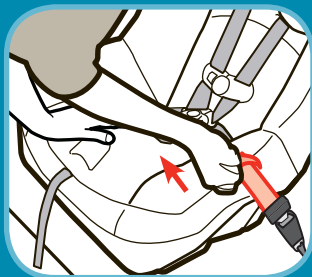

Place hand in child restraint and firmly push down and towards the vehicle seat back while pulling up on the free end of belt to tighten.

49

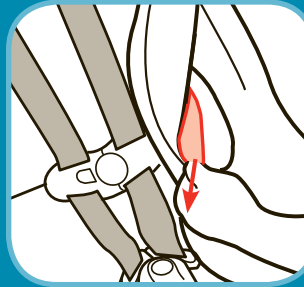

It may be easier to tighten the belt through the belt path opening as shown.

### 5. Tighten Tether



Push firmly on the back of the seat and tighten tether strap.

### 6. Check Belt Tightness



Grasp the child restraint at the belt path with one hand. Push and pull the child restraint from side to side, forward and back. The child restraint should not move more than 1 in. (2.5 cm).

**NOTE:** If it moves more than 1 in. (2.5 cm), try reinstalling the child restraint or try another seating location.

Secure child in child restraint.

50

## Using the Locking Clip

You will rarely need to use a locking clip except in some older vehicles. Built in child restraint locking systems have been required in vehicles since 1996, and many vehicles had these features even earlier.

Check your vehicle owner's manual to learn how to use the systems in your vehicle. If you need a locking clip, return to the store where you purchased this child restraint to purchase a locking clip or call us at 1-800-544-1108 to order one.

Locking clips from any child restraint manufacturer are okay to use.

Remove the locking clip when the vehicle seat belt is not being used with the child restraint. A locking clip will not fix all types of seat belt problems.

Refer to section D-4 to determine if your vehicle belts require a locking clip.

Directions below describe installing the child restraint rear-facing. Same steps apply for forward-facing, except install the restraint forward facing and thread the vehicle belt in the forward facing belt path.

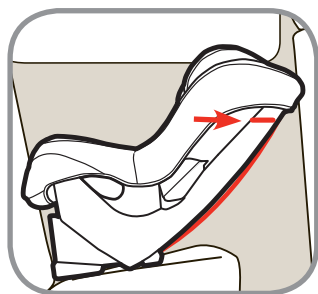

### 1. Place Child Restraint in Vehicle Rear Facing

**NOTE:** Store tether. See section F-2.

With child restraint in the reclined position, make sure level-to-ground line on the side of the child restraint is level with ground.

Adjust child restraint if needed.

51

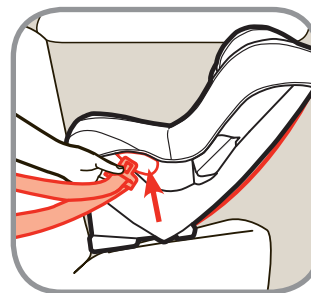

### 2. Thread Vehicle Belt

Thread the vehicle lap/shoulder belt combination through the rear-facing belt path.

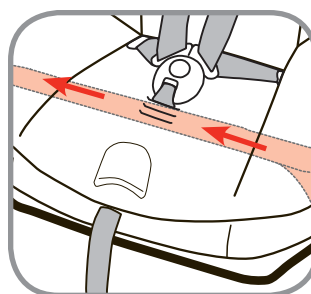

### 3. Pull Latch Plate Across to Opposite Side

Reach under pad and pull the vehicle belt across the shell in front of buckle strap and out opposite side.

**Do not place vehicle belt over child's legs.**

Buckle vehicle belt.



### 4. Tighten Vehicle Belt

Place hand in child restraint and push firmly down and towards the vehicle seat back while pulling up on the shoulder belt to tighten.

52

*continued on next page.*

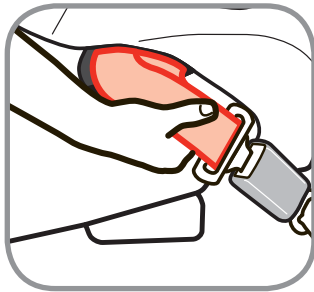

### 5. Locate Locking Clip Location

Grasp both vehicle belts together just behind the latch plate and unbuckle.

**NOTE:** If the latch plate ends up just at the belt path opening, grasp the vehicle belts on the opposite side of the child restraint, as close to the latch plate as possible.

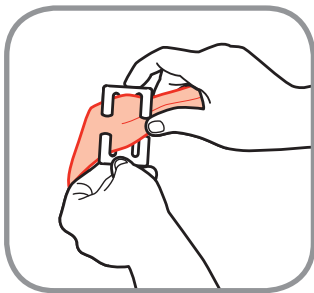

### 6. Attach Locking Clip

Thread both portions of the vehicle belt onto the locking clip, as close to the latch plate as possible.

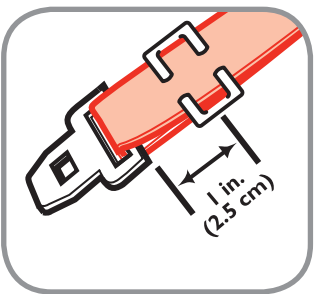

### 7. Position Locking Clip

Position locking clip about 1 in. (2.5 cm) from vehicle belt's latch plate.

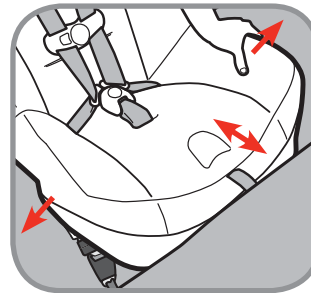
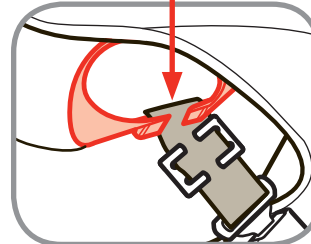
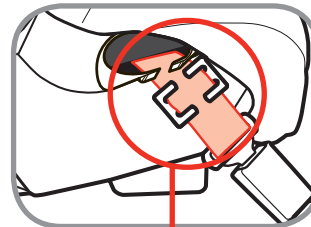

### 8. Rebuckle Belt

**NOTE:** The vehicle belt **MUST** be threaded into the belt positioning guide as shown on both sides of shell.

### 9. Check Belt Tightness

Grasp the child restraint **at the vehicle belt path with one hand**. Push and pull the base from side to side, forward and back. The child restraint should not move more than 1 in. (2.5 cm).

**NOTE:** If restraint moves more than 1 in. (2.5 cm), try reinstalling the child restraint or try another seating location.

**Secure child in child restraint.**

**Recheck the recline angle. Repeat steps if not reclined correctly.**

**Remove the locking clip when the seat belt is not being used with a child restraint.**

## Troubleshooting

**1. If the child restraint buckle or harness release lever sticks or you cannot get the straps tight enough around child:**

**DO NOT LUBRICATE.** Check around lever and retractor for dropped food, sticky spilled drinks, dirt, leaves, etc. Clean with warm water and/or remove object with tweezers. If you cannot get the harness to adjust and remain tight with the buckle securely locked, do not use the child restraint.

**2. If your harness twists:** Straighten the harness each time you put your child in the child restraint to help prevent twisting. Lock the buckle and tighten harness and it will be ready for next use.

**3 Locate a Child Safety Seat Inspection Station for hands on training on how to use your child restraint:**

Visit your local Child Passenger Inspection Station or go to <http://www.nhtsa.dot.gov/cps/cpsfitting/index.cfm> to find your closest station.

## Replacement Parts Order Form

Complete the form below. Your model number with color code and manufacturer date code **MUST** be included on the form to ensure proper replacement parts. Your model number with color code and the date code can be found on a sticker on the side of child restraint. Payment in U.S. dollars must accompany your order. Choose parts needed from the list on the next page.

Return the form with payment to:

**Dorel Juvenile Group, Inc.**  
**Consumer Relations Department**  
**P.O. Box 2609**  
**Columbus, IN 47202-2609**

Fax orders to: 1-800-207-8182

Please make money orders payable to Dorel Juvenile Group, Inc. Fill in the area below to charge to Visa or Mastercard. We do not accept personal checks or Discover Card. All outside of U.S. and Canada **MUST** use credit card.

Ship To (Please Print): \_\_\_\_\_

Name: \_\_\_\_\_

Address: \_\_\_\_\_

City: \_\_\_\_\_

State/Province: \_\_\_\_\_ Zip \_\_\_\_\_

Telephone: \_\_\_\_\_

Email Address: \_\_\_\_\_

**We **MUST** have this information  
to process your order:**

**Model Number (8 to 9 characters):** \_\_\_\_\_

**Manufacture Date (mm/dd/yyyy):** \_\_\_\_\_

## Replacement Parts List

**NOTE:** If requested color is not available, similar color will be substituted. Prices are subject to change.

Part	Cost	Quantity	Total Cost
Buckle Strap/Buckle....	\$4.99	X _____	= \$ _____
Seat Pad.....	\$50.00	X _____	= \$ _____
Chest Clip.....	\$1.50	X _____	= \$ _____
Locking Clip .....	\$2.50	X _____	= \$ _____
Tether Kit .....	\$9.99	X _____	= \$ _____
Latch Kit.....	\$24.99	X _____	= \$ _____
Instructions .....	\$0.00	X _____	= \$ _____

**Merchandise Total** \$ \_\_\_\_\_

**Shipping and Handling:** \$ \_\_\_\_\_

Up to \$25.00 .....	\$5.95	\$150.01 to \$200.00 .....	\$11.95
\$25.01 to \$50.00 .....	\$6.95	\$200.01 and up .....	\$13.95
\$50.01 to \$75.00 .....	\$8.95		
\$75.01 to \$100.00 .....	\$9.95	Outside Continental USA	\$10.00
\$100.01 to \$150.00 .....	\$10.95		

**Sales Tax** \$ \_\_\_\_\_  
 (Indiana, California, and Massachusetts residents add applicable sales tax.)

**Grand Total** \$ \_\_\_\_\_

No shipping and handling on instructions for quantities under 6. Add \$.50 for each instruction over 6, then add applicable shipping and handling.

**Fill Out For Credit Card**

Visa    Mastercard

**Card Exp. Date:** \_\_\_\_\_

**Cardholder's Name:** \_\_\_\_\_

**Card Number:** \_\_\_\_\_

**Signature** \_\_\_\_\_

CUT ON DOTTED LINE

## Warranty

Dorel Juvenile Group, Inc. (DJG) warrants this product to the original retail purchaser as follows:

This product is warranted against defective materials or workmanship for one year from the date of original purchase. **An original receipt is required to validate your warranty.** DJG will, at its option, provide replacement parts or replace this product. DJG reserves the right to substitute if the part or model has been discontinued.

To make a claim under this warranty you may contact us at consumer@djgusa.com fax us at 1-800-207-8182 24 hours a day, write to DJG, Consumer Relations Department, P. O. Box 2609, Columbus, IN 47202-2609, or call 1-800-951-4113 from 8:00 a.m. to 6:00 p.m. EST Monday through Thursday and from 8:00 a.m. to 4:30 p.m. on Friday. **Proof of purchase is required and shipping charges are the responsibility of the consumer.**

**Warranty Limitations:** This warranty does not include damages which arise from misuse or abuse of this product.

**Limitation of Damages:** The warranty and remedies as set forth are exclusive and in lieu of all others, oral or written, expressed or implied. In no event will DJG or the dealer selling this product be liable to you for any damages, including incidental or consequential damages, arising out of the use or inability to use this product.

**Limitation of warranties and other warranty terms and state law rights:** Any implied warranties, including implied warranties of the merchantability and fitness for a particular purpose, shall be limited to the duration and terms of the express written warranty. Some states do not allow limitations as to how long an implied warranty lasts or the exclusion or limitation of incidental or consequential damages, so the above limitations may not apply to you. This warranty gives you specific legal rights, and you may have other rights, which vary from state to state. Neither DJG nor the dealer selling this product authorized any person to create for it any other warranty, obligation, or liability in connection with this product.

**Please note:** Our product warranty only applies when purchased from an authorized Maxi-Cosi retailer. The origin of products not purchased through these authorized retailers is unknown and could be counterfeit. We cannot support products from an unknown origin as we cannot verify the handling or condition of such merchandise. We maintain a strong network of authorized retailers to ensure you are purchasing safe and complete products. Fulfillment by a third party does not guarantee you are purchasing from one of these authorized retailers. Pricing which is inconsistent with the majority of retailers is a strong indication that the retailer is not authorized, as we have a consistent price offering across all authorized retailers. If you are unsure of the authorization status of a retailer you are considering purchasing from, or have purchased from, you can check maxi-cosi.com or call our Consumer Relations department at 1-(800) 951-4113.