

Karaoke USA

DVD/CDG/MP3G KARAOKE PLAYER

User's Guide

MODEL:
GF829



(ipod® not included)

Before operating this product, please read these instructions.

Contents

Warnings and Precautions.....	01
Important Safety Instructions.....	02
Caution.....	03
What's in the giftbox.....	04
Song List on your Disc.....	05-06
Features.....	07
Front Panel Illustration.....	08
Top Panel Illustration.....	09
Connecting to a TV Set.....	10
Connect MP3/MP4/iPod®.....	10
Remote Control.....	11
Remote Control Operation.....	12-15
How to Play a Disc.....	16
MP3G Disc and MP3G Format Music Playback.....	17
Play SD Card and USB.....	18-19
Record Operation Procedures.....	20
Playback the Recorded File.....	21
The Setup Menu System.....	22-23
Specifications.....	24
Troubleshooting.....	25

Warnings and Precautions

WARNING: To reduce the risk of fire or electric shock, do not expose this unit to rain or moisture.

CAUTION: Use of controls or adjustments or performance of procedures other than those specified may result in hazardous radiation exposure.

“**Caution Marking and Rating Label**” is affixed under the lid or on the bottom of the unit with a mass not exceeding 7kg.

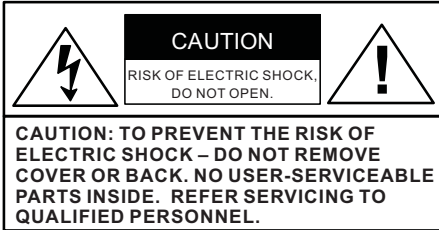

This symbol is intended to alert you to the presence of uninsulated, dangerous voltage within the unit's enclosure that might be of a sufficient magnitude to constitute a risk of electric shock. DO NOT OPEN THE UNITS CASE.



This symbol is intended to inform you that important operating and maintenance instructions are included in the literature accompanying this product.

SAFETY

For units with an insertable AC Power Adapter cordset:

- The power adapter should remain operable for its intended use. Disconnect the AC Power Adapter if you are not intending to use the unit for a long period of time.
- When connecting or disconnecting the AC Power Adapter Cord, grip the plug and not the cord itself. Pulling the cord may cause damage and create a hazard.

For units with a Rechargeable Battery:

- Do not expose batteries to excessive conditions – extreme cold, heat, sun or fire.

MOISTURE AND CONDENSATION

If the unit is exposed to moisture and extreme cold temperatures and moved to a warm environment, condensation may form on the units internal components. Under these circumstances, turning the power “ON” may cause damage to the unit or cause harm to the user. Allow the unit to stand in a warm environment for 1 to 3 hours and allow the unit to air dry safely.

WHEN IN USE

- Do not use this unit in conditions that are extreme – hot, cold, dusty or humid.
- Do not restrict the air flow of the unit by placing it on a soft surface like a bed, carpet or covering.

FCC INFORMATION

This unit complies with part 15 of the “FCC Rules.” Operation is subject to the following conditions:

1. This unit may not cause harmful interference.
2. This unit must accept any interference received, including interference that may cause undesirable operation.



Double insulation.
This is a Class II apparatus.

Important Safety Instructions

1. Read These Instructions: All safety and operations manual should be read before the product is operated.

2. Keep These Instructions: The safety and operations manual should be retained for future reference.

3. Heed All Warnings: All warnings applicable to the unit and in the operations manual should be adhered to.

4. Follow All Instructions: All operations manual should be followed.

5. Water and Moisture: Do not use this unit near water. For example, do not use near a bath tub, wash bowl, kitchen sink, or laundry tub. Do not use this unit in a wet basement or near a swimming pool or similar location. The unit shall not be exposed to dripping or splashing and no objects filled with liquids (ex: vases), shall be placed on or near this unit.

6. Cleaning: Clean the unit only with a dry cloth. Unit must be unplugged from the wall outlet before cleaning. Do not use liquid cleaners or aerosol cleaners on the unit.

7. Ventilation: Slots and openings in the cabinet of the unit are provided to ensure reliable operation and ventilation and to protect the unit from overheating. The openings must not be covered and should never be blocked by placing the product on a soft surface like a bed, sofa, or rug. This unit should not be placed in a built-in installation like a bookcase or rack, unless proper ventilation is provided.

8. Heat: Do not install the unit near any heat source like a radiator, heat register, stove or other device that produces heat, including amplifiers.

9. Grounding or Polarization: If applicable, do not disable or circumvent the polarized or grounding-type plug. A polarized plug has 2 blades with 1 wider than the other. A grounding-type plug has 2 blades and a 3rd grounding plug. The wide blade, or the 3rd prong, is provided for your safety. If the provided plug does not fit into an outlet, consult a qualified electrician for replacement of this outlet.

10. Power Cord Protection: Protect the power cord from being walked on, pinched or cut or damaged in any

way. If any damage occurs, consult with a trained technician for repair.

11. Accessories: Only use accessories registered and approved by the manufacturer. Do not place this unit on an unstable cart, stand, tripod, bracket or table that has not been previously approved by the manufacturer. This unit may fall, causing serious injury to a child, adult or to the unit itself. Any mounting of the unit should be done within the manufacturer's guidelines.

12. Transporting: If a pre-approved device is used to transport this unit, caution and care must be observed and practiced to avoid damages. Make sure the device and unit together are stable before moving.



PORTABLE
CART
WARNING

13. Lightning: Unplug this unit and disconnect the antenna or cable system during lightning storms or when unused for long periods of time. This will help prevent damage to the unit due to lightning and power line surges.

14. Servicing: Do not attempt to service this unit yourself. Opening or removing covers may expose you to dangerous voltage or other hazards. Refer all servicing to a qualified service technician.

15. Power Sources: Only connect to the type of household power supply as indicated in the operations manual and "Caution Marking and Rating Label." If you are not sure of the type of power supplied to your home (or location of the outlet the unit is being plugged into), consult with the local power company. For units intended to operate from battery power, or other sources, refer to the manufacturer's operations manual.

16. Overloading: Do not overload wall outlets or extension cords. This can result in a risk of fire or electric shock and may be hazardous.

17. Foreign Material: Protect this unit from intrusion of any foreign substances like dirt, water, moisture and insects. Do not force any foreign materials or chemicals into this unit. This could result in a risk of fire or electric shock and may be hazardous.

18. Replacement Parts and Safety Check: When replacement parts are required, be sure the service technician has used replacement parts specified and approved by the manufacturer. Ask the service technician to perform safety checks to ensure the proper operation to avoid possible fire, electric shock or other hazards.

19. Outdoor Antenna Grounding: If an outside antenna or cable system is connected to the unit, be sure the antenna or cable system is grounded to provide some protection against voltage surges and built-up static charges. If there is any doubt to the proper grounding of these systems, contact a qualified electrician to inspect your location.

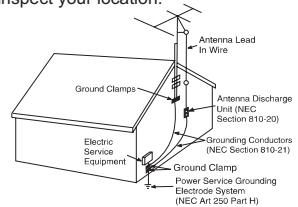

20. Wall or Ceiling Mounted: The unit should be mounted to a wall or a ceiling only as recommended by the manufacturer.

21. Disconnect Device: Make sure all disconnect devices are in proper working condition and readily available in the event of an emergency or if power "off" is needed quickly.

22. Protective Attachment Plug: If applicable, this unit may be equipped with an attachment plug having overload protection. This is a safety feature. See the operations manual for replacement or resetting of this protective device. If replacement of the plug is required, be sure the qualified service technician has used a replacement plug specified by the manufacturer that has the same overload protection as the original plug.

23. Power Lines: An outside antenna system should not be located in the vicinity of overhead power lines or other electric light or power circuits, or where it can fall into such power lines or circuits. When installing an outside antenna system, extreme care should be taken to keep from touching such power lines or circuits, as contact with them may be fatal. Always consult with your local power company before installing an outside antenna.

Caution

- Please use the original box and packing materials for safe transportation of this product.

- It is normal for the cover and rear panel to become warm after the player has been operating for an extended period of time.

- Do not move this product during playing. Doing so may cause damage to the pickup and the disc.

- Press OPEN CD DOOR button to open tray. Do not push or pull tray. Do not touch tray when opening or closing.

- This unit does not fully support the USB Playing and Record/ Ripping.

- Warning: When the EQ function is turned on, the Ripping effect/ result would not be good/ ideal.

- Do not use hard or sharp instruments to touch the TFT Screen, it may scratch or damage its surface!

What's in the Giftbox



GF829 x1



Microphone x 2



RCA Cables x 1

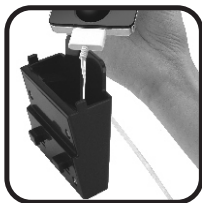

MP3/iPod
Holder x 1



AC
Adaptor x 1



2 AAA Batteries
Not Included

Remote
Control x 1

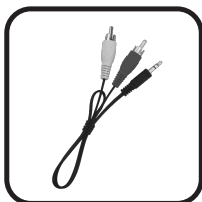

Cable for iPod x 1

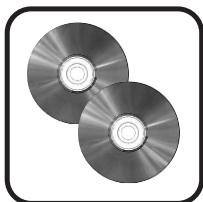

Disc x 2



Users Manual x 1



Warranty Card x 1

Song List on your Discs

9347 Sing A Long Karaoke Songs (200 Traditional Karaoke Songs)

- Alexander's Ragtime Band
- All Things Bright And Beautiful
- All Through The Night
- Alouette
- Alphabet Song, The
- America (My Country 'Tis Of Thee)
- Animal Fair
- Around And Around The Village
- Aye Aye Aye Aye The Limerick Song
- B I N G O
- Baa Baa Black Sheep
- Barney Buntline
- Be Kind To Your Web Footed Friends
- Bear Went Over The Mountain
- Big Rock Candy Mountain
- Billy Boy
- Billy Pringle
- Bird's Song
- Blessed Assurance
- Blow The Man Down
- Blue Bells Of Scotland
- Bluebird
- Bollweevil
- Bye, Baby Bunting
- Caissons Go Rolling Along
- Calendar Song
- Camptown Races
- Capital Ship, A
- Cat Came Back, The
- Cinderella
- Clementine
- Cock A Doodle Doo
- Cockles And Mussels
- Cocky Robin
- Colors
- Come, O Come, Emanuel
- Counting Song
- Crawdad Song
- Crocodile, The
- Cuckoo Is A Pretty Bird
- Day And Night
- Dixie
- Do Your Ears Hang Low
- Dry Bones
- Elephant And The Flea
- Father Grumble
- Fiddle De De
- Fishes
- Five Currant Buns
- For He's A Jolly Good Fellow
- For Me And My Gal
- Fox
- Frere Jacques
- Froggie Went A Courting
- Georgie Porgie
- German Lullaby
- Girls And Boys Come Out To Play
- Git Along Little Dogies
- Golden Slumbers
- Good Morning Merry Sunshine
- Goosey Goosey Gander
- Grasshopper
- Grasshoppers Three
- Greensleeves
- Ground Hog
- Harrigan
- Here We Go Around The Mulberry Bush
- Here We Go Looby Loo
- Hey Diddle Diddle
- Hickory Dickory Dock
- Higgledy Piggledy My Black Hen
- Home On The Range
- Humpty Dumpty
- Hunting We Will Go, A
- Hush Little Baby
- Hush-a-bye
- I Am A Young Musician
- I Gave My Love A Cherry
- I Had A Little Nut Tree
- I Love You Truly
- I Spy
- If You're Happy And You Know It
- I'll Take You Home Again, Kathleen
- I'm A Little Teapot
- I'm Always Chasing Rainbows
- I'm Looking Over A Four Leaf Clover
- In The Good Old Summertime
- It Ain't Gonna Rain No More
- It's Raining It's Pouring
- I've Been Working On The Railroad
- Jack And Jill
- Jack Be Nimble
- Jack Spratt
- Jenny Jenkins
- Jimmy Crack Corn
- Lady Bird Lady Bird
- Letters Of The Alphabet
- Little Black Bull
- Little Boy Blue
- Little Jack Horner
- Little Sally Waters
- Little Things, The
- Little Tommy Tucker
- London Bridge Falling Down
- London Street
- Ma She's Making Eyes At Me
- Mademoiselle From Armentieres
- Marine's Hymn
- Michael Row The Boat Ashore
- Midnight Special, The
- Moonlight Bay
- My Old Dog Tray
- My Old Hen
- Now I Lay Me Down To Sleep
- Oats Beans And Barley Grow
- Off To Bed Now
- Oh Dear What Can The Matter Be
- Ol Woman Who Lived In A Shoe
- Old Blue
- Old John Braddlem
- Old Mother Hubbard
- On The Banks Of The Sacramento
- On Top Of Old Smokey
- One Meat Ball
- One Two Buckle My Shoe
- One Two Three Four Five
- Oranges And Lemons
- Over In The Meadow
- Over The River And Through The Woods
- Pat A Cake
- Pease Porridge Hot
- Peg O' My Heart
- Peter Peter Pumpkin Eater
- Polly Put The Kettle On
- Polly Wolly Doodle
- Pop Goes The Weasel
- Ride A Cock Horse To Banbury Cross
- Right Hand Says Good Morning
- Ring Around The Rosie
- Rise And Shine
- Rock A Bye Baby
- Rock A Bye Baby Green
- Rock Island Line
- Rocking The Cradle
- Rose Of Tralee
- Row Row Row Your Boat
- Russian Cradle Song
- Sailing Sailing
- School Days
- She'll Be Coming Around The Mountain
- Shoo Fly Don't Bother Me
- Shortening Bread
- Simple Simon
- Sing A Song Of Sixpence
- Six Little Ducks
- Skip To My Lou
- Sleep Baby Sleep
- Spelling
- Spider And The Fly, The
- Star Spangled Banner, The
- Sur Le Pont D'avignon
- Swanee River
- Sweetly Sings The Donkey
- Swing Low Sweet Chariot
- Tailor And The Mouse
- Take Me Out To The Ball Game
- Ten In A Bed
- The Ants Go Marching
- The Eensy Weensy Spider
- The Farmer In The Dell
- The Holly And The Ivy
- The Muffin Man
- The Old Gray Mare
- There Was A Little Man
- There Was A Tree
- There's A Hole In Middle Of Sea
- This Little Pig Went To Market
- This Old Man
- Three Blind Mice
- Three Little Kittens
- Three Little Pigs
- Tisket A Tasket, A
- To Market To Market
- Toot Toot Toosie Goodbye
- Try Try Again
- Tura Lura Lura
- Turkey In The Straw
- Vive La Compagne
- Wabash Cannonball, The
- Waltzing Matilda
- We Hunted And We Hunted
- We Three Kings
- What Child Is This
- When Johnny Comes Marching Home
- Where Oh Where Has My Little Dog Gone
- Who Threw The Overalls In Mrs. Murphy's Chowder
- Wish You A Happy Birthday
- World Turned Upside Down, The
- Yankee Doodle
- Yellow Rose Of Texas

Song List on your Discs

9346 Holiday Favorites (100 Traditional English and Spanish Karaoke Songs)

1. Abide With Me
2. Amazing Grace
3. Angel De Los Reinos Santos
4. Angels From The Realms Of Glory
5. Angels We Have Heard On High
6. April Shower
7. Auld Lang Syne
8. Ave Maria
9. Away In A Manger
10. Battle Hymn Of The Republic
11. Bicycle Built For Two
12. Bill Bailey, Won't You Come Home
13. Boom, Boom, Ain't It Great To Be Crazy
14. Brahms' Lullaby
15. Bringing In The Sheaves
16. Campanas de Navidad
17. Church in The Wildwood
18. Con Mi Burrito Sabanero
19. Daddy Sang Bass
20. Danny Boy
21. Deck The Halls
22. Ding Dong Que Alegria
23. Doce Dias De Navidad
24. Down By The Riverside
25. El Buen Rey Wenceslao
26. El Primer Noel
27. El Tamborilero
28. First Noel, The
29. Frankie And Johnny
30. Give My Regards To Broadway
31. Go Tell It On The Mountain
32. God Rest Ye Merry Gentlemen
33. Hail Hail The Gang's All Here
34. Hark! The Herald Angels Sing
35. He's Got The Whole World In His Hand
36. His Eye Is On The Sparrow
37. How Great Thou Art
38. I Love To Tell The Story
39. I'll Fly Away
40. In The Garden
41. It Came Upon A Midnight Clear
42. It Is No Secret What God Can Do
43. Jeannie With The Light Brown Hair
44. Jesus Loves Me
45. Jingle Bells (Childrens)
46. Joy To The World
47. Just A Closer Walk With Thee
48. Let Me Call You Sweetheart
49. Little Bo Peep
50. Little Miss Muffet
51. Llego A Mi Medianoche
52. Los Tres Reyes
53. Mary Had A Little Lamb
54. Mary Quite Contrary
55. Mozart's Lullaby
56. My Bonnie Lies Over The Ocean
57. My Old Kentucky Home
58. My Wild Irish Rose
59. Navidad, Navidad
60. Noche De Paz
61. Noche Santa
62. O Holy Night
63. Oh Christmas Tree
64. Oh Come All Ye Faithful
65. Oh Little Town Of Bethlehem
66. Oh Ven Oh Ven Emmanuel
67. Oh When The Saints Go Marching In
68. Oh You Beautiful Doll
69. Oh, Susanna
70. Old King Cole
71. Old MacDonald Had A Farm
72. Old Time Religion
73. One Day At A Time
74. One More River To Cross
75. Onward Christian Soldiers
76. Peace In The Valley
77. Precious Lord Take My Hand
78. Precious Memories
79. Rock Of Ages
80. Rock-A-My Soul
81. Silent Night
82. Sweet By And By
83. Sweet Hour Of Prayer
84. The Little Drummer Boy
85. The Lord's Prayer
86. The Old Rugged Cross
87. This Little Light Of Mine
88. Toda La Noche
89. Twelve Days Of Christmas
90. Twinkle Twinkle Little Star
91. We Gather Together
92. We Wish You A Merry Christmas
93. Wedding Song (There Is Love)
94. What A Friend We Have In Jesus
95. When Irish Eyes Are Smiling
96. When The Roll Is Called Up Yonder
97. While Shepherds Watched, Their Flocks
98. Whispering Hope
99. Ya Llego La Navidad
100. You're A Grand Old Flag

Features

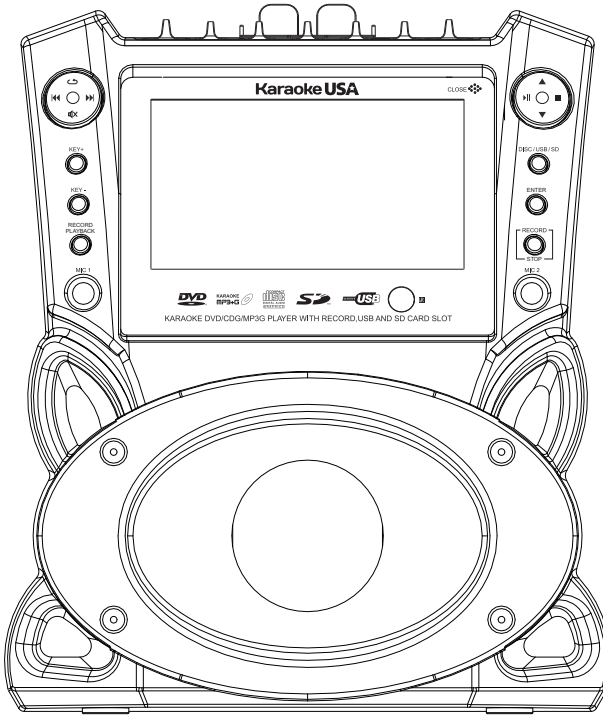

- **DVD/CD+G/MP3+G Karaoke Player**
- **7" TFT Color Screen**
- **Record CD+G/MP3+G and Voice**
- **Record and Instant Playback**
- **20W Peak Power Output**
- **Remote Control**
- **2 Microphones**
- **2 Microphone Inputs**
- **2 Microphone Holders**
- **USB/SD Card Slots**
- **USB Charger for MP3/iPod**
- **Analog Echo Control**
- **Balance Control**
- **Digital Key Control**
- **Audio and Video Input**
- **Audio and Video Output**
- **Audio/Video RCA Cable**
- **3.5mm to RCA Cable**
- **AC 100V~240V**
AC/DC Adaptor Included
- **DC 12V Car Adaptor (Optional)**

Front Panel Illustration

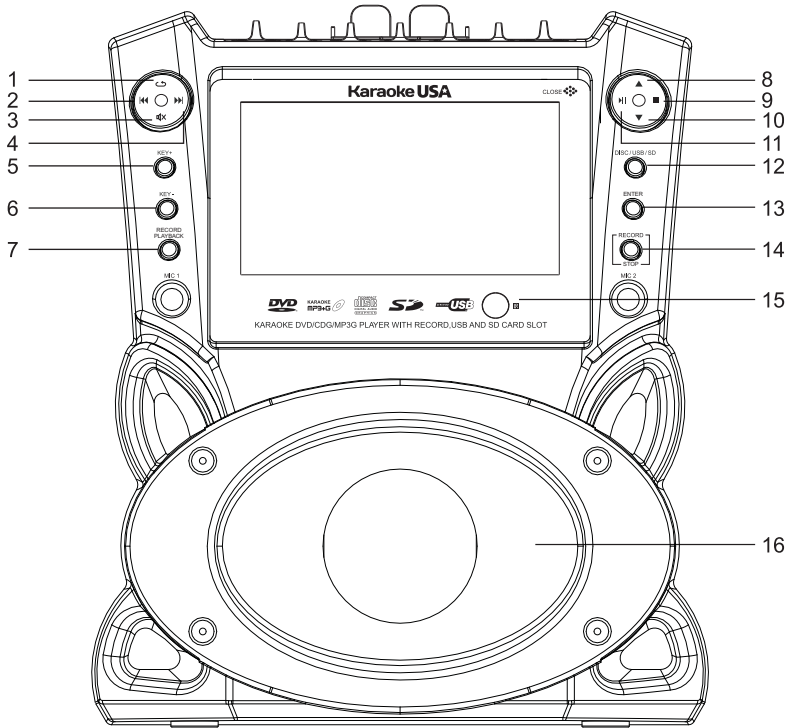

- 1. : Repeat the Song Playing
- 2. : PREVIOUS Song
- 3. : Mute the Audio Output
- 4. : Next Song
- 5. Key+ : Raise the Tone
- 6. Key- : Lower the Tone
- 7. Record Playback:
Playback the Recorded Track
- 8. : Navigate UP in the Menu
- 9. : Stop

- 10. : Navigate DOWN in the Menu
- 11. : Play or Pause
- 12. DISC-SD-USB: Choose Content
Source Disc, SD or USB
- 13. Enter: Select a Menu Item
- 14. RECORD/STOP:
Record Start & Stop
- 15. : Remote Control Infrared
Receiver
- 16. Speaker: Audio Speaker

Top Panel Illustration

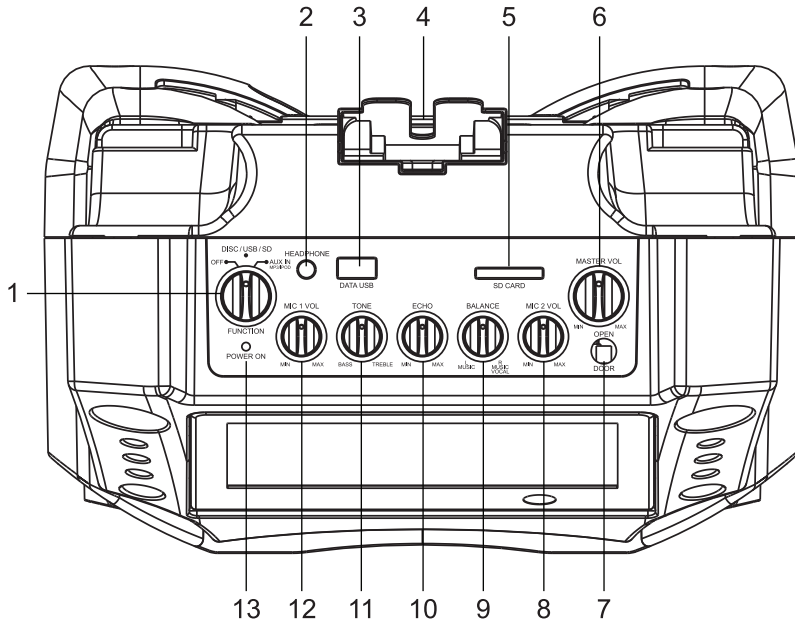

1. **POWER & FUNCTION:** Switch the player ON/OFF, Select Play mode in Disc, USB, SD or AUX
2. **HEADPHONE:** Standard 3.5mm headphone jack
3. **USB DATA:** For transferring songs from your USB stick
4. **CRADLE:** Removable Personal Player Cradle for holding iPod®, MP3, MP4 players
5. **SD CARD SLOT:** SD slot to accommodate SD cards
6. **MASTER VOL:** Master volume control
7. **CD DOOR OPEN BUTTON:** Open CD door
8. **MIC 2 VOL:** Volume control for microphone
9. **BALANCE:** Music only/music and vocal
10. **ECHO:** Add an echo effect to singer's voice
11. **TONE:** Adjust music tone
12. **MIC 1 VOL:** Volume control for microphone
13. **POWER LED:** Power indicator

Connecting to a TV Set

To watch lyrics on your TV screen, connect yellow (video), red (audio) and white (audio) RCA ends into matching color jacks on TV. To view lyrics, you must select an input channel on your TV (Video 1, Video 2, Aux., etc.) It will never be channels 2, 3, 4, 5, etc.

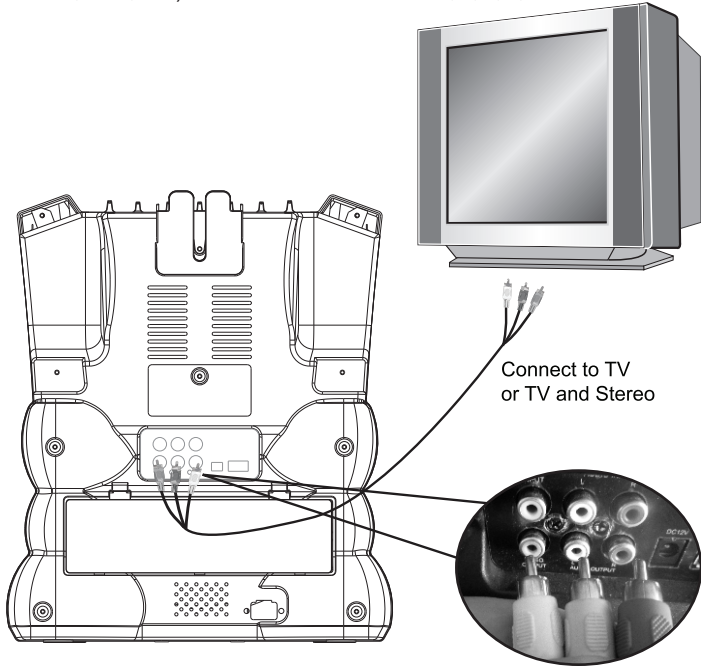

Note:

Use composite video cable and left/right audio cable.

Connect MP3/MP4/iPod®

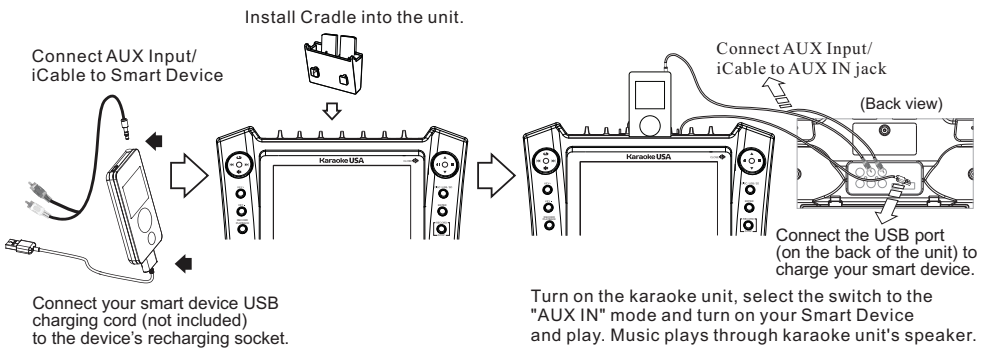

**Works with iPod®, MP3 & MP4 Players. (iPod®, MP3 & MP4 Personal Players not included)
iPod® is a registered trademark of Apple, Inc.
All rights reserved**

Remote Control

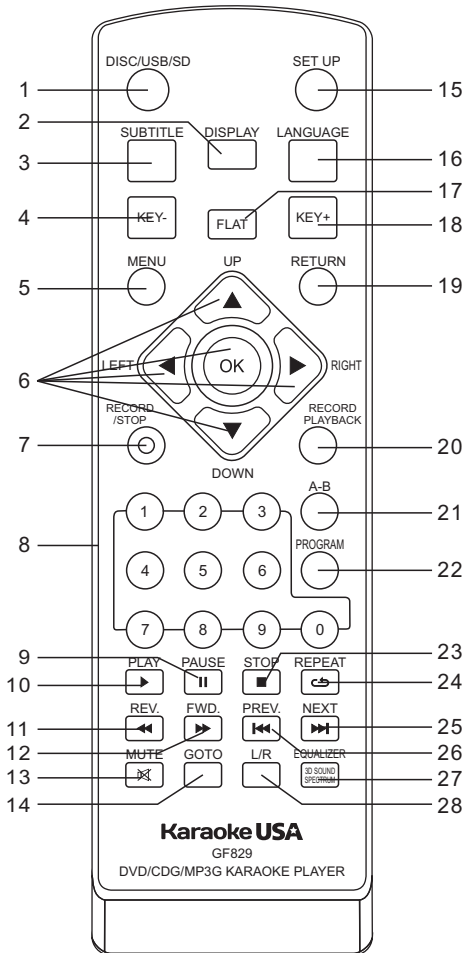

1. DISC/USB/SD
2. DISPLAY
3. SUBTITLE
4. KEY-
5. MENU
6. UP/DOWN/LEFT/RIGHT/
OK BUTTON
7. RECORD/STOP
8. NUMBER KEYS
9. PAUSE
10. PLAY
11. REV.
12. FWD.
13. MUTE
14. GOTO
15. SET UP
16. LANGUAGE
17. FLAT
18. KEY+
19. RETURN
20. RECORD PLAYBACK
21. A-B
22. PROGRAM
23. STOP
24. REPEAT
25. NEXT
26. PREV.
27. EQUALIZER
28. L/R

NOTE:

1. Please note that reference numbers for the remote are described at the beginning on page 10 of this manual.
2. In this manual, “◀” “▶” “▲” “▼” will be used to represent different NAVIGATION ARROWS on the remote respectively.
3. In order to operate any of the remote functions, you must first turn on the Karaoke Player & Select the “DISC” mode.

Remote Control Operation

1. DISC/USB/SD



● Press to change media in [DISC->USB->SD]. Select and press "OK".



2. DISPLAY



● During playback, press DISPLAY to show the current time counter position.

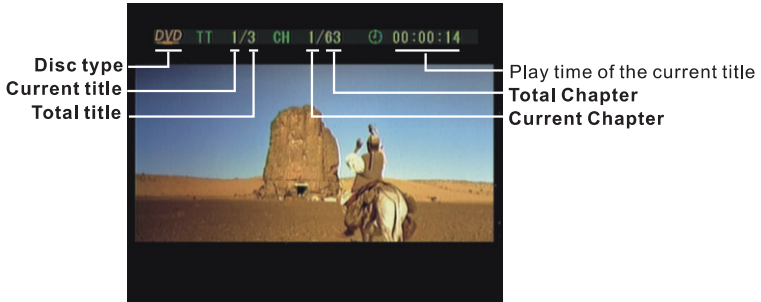

Press DISPLAY to show the audio and subtitle message menu.

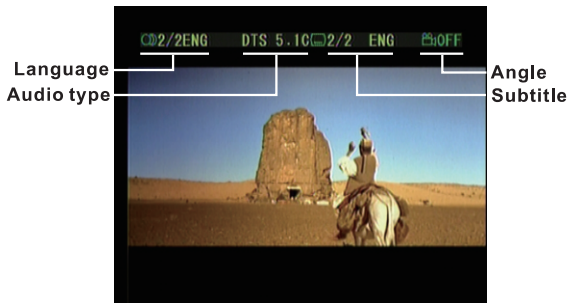

3. SUBTITLE



● Press to display the subtitles.
(Only applicable in movie, depends on your disc or your download file.)

4. KEY-



● Transpose the music key down.

5. MENU



● During DVD playback, press MENU to return to the program menu.
Note: This function is subject to the disc.

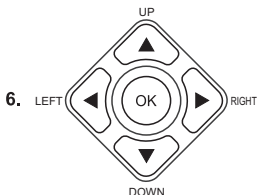

6. ● Used for navigation within a selection menu.

7. RECORD /STOP



● Record your vocal and music to the USB or SD card.
(Note: USB or SD card must be inserted before start recording. DVD disc is not available for recording.)

Remote Control Operation

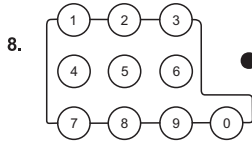

8. ● Used to specify a track number for playing, changing, or programming.



9. ● Press PAUSE during playback to pause playback.



10. ● Press PLAY from stop mode to start play.



11. ● During CD/DVD playback, press or hold to scan reverse. The player will review the disc at 2,4,8 and 20 times normal speed as follows:

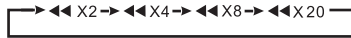

Press PLAY to resume normal playback.



12. ● During CD/DVD playback, press or hold to scan forward. The player will review the disc at 2,4,8 and 20 times normal speed as follows:

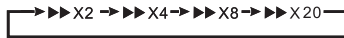

Press PLAY to resume normal playback.



13. ● Press MUTE to mute the Audio output.
● Press MUTE again to resume normal Audio output.



14. ● During playback, press GOTO show the current time counter position.

Enter number to choose the title

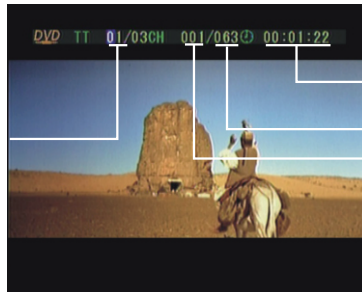

Enter number to choose the Play time.

Total Chapter

Enter number to choose the Chapter.

15. SETUP



- Press to setup the TV settings according to your needs.

16. LANGUAGE



- To show the movie language.(Depends on your download file.)







17. ● Set the music key as normal.



18. ● Transpose the music key up.

Remote Control Operation



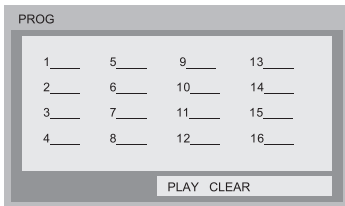

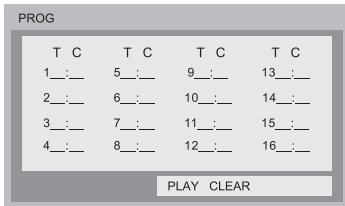

19. **RETURN**  ● Works with the PBC function to return to a menu screen while playing.
20. **RECORD PLAYBACK**  ● Press this button to listen the music that you **JUST** recorded.
21. **A-B**  ● Press A-B first to set location A: REPEAT: A-, press again to set location B, and then playback will repeat during the two locations: REPEAT: A-B. Press A-B the third time to cancel the function and return to normal playback: REPEAT: CANCEL.
22. **PROGRAM**  ● This is the function provide you to listen the tracks in a desire order.
While [PROGRAM] is on, press ENTER to display the [Program submenu]:



Input the track numbers in the order you would like them to play. When you have finished, press PLAY then press ENTER to play the tracks in the new programmed order. Select CLEAR then press ENTER to clear all numbers.



Input the title and chapter numbers in the desired order. Then press PLAY then press ENTER to play the chapters in the order you have set. Select CLEAR then press ENTER to clear all the numbers.

23. **STOP**  ● Press STOP once during playback to stop and hold playback.
● Press PLAY to resume playback from the point you pressed STOP.
● Press STOP twice to stop playback completely.
24. **REPEAT**  ● Press this key to play selected item repeatedly.
The screen shows as below:
REP: [OFF] REP: [REP1] REP: [REP ALL]
25. **NEXT**  ● Press NEXT to skip to next chapter or track.
26. **PREV.**  ● Press PREV. to skip to previous chapter or track.
27. **EQUALIZER**  ● This key is set the different sound effect of the music.
28. **L/R**  ● Activates the multiplex function, which switches to NORMAL (stereo), L-ch monaural and R-ch MONAURAL.

Remote Control Preparation

Battery installation

1. Open the cover

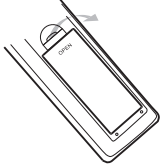

2. Install batteries (AAA 1.5Vx2, not included)

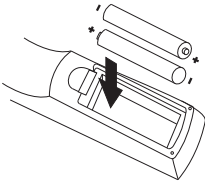

3. Close the cover

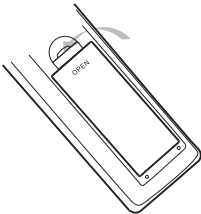

Using the remote control

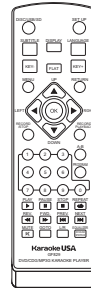
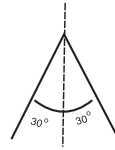
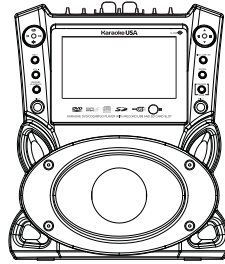

Notes:

- Point the remote control directly at the player's remote sensor.
- Do not leave the remote control in an extremely hot or humid place.
- Do not spill water or put anything wet on the remote control.
- When this machine will not be used for an extended period of time, please remove all batteries from the Battery Compartment.

How to Play a Disc

Your GF829 will support CD, CDG, MP3, MP3G and DVD format disc.

1. Connect the DC adaptor to the unit;

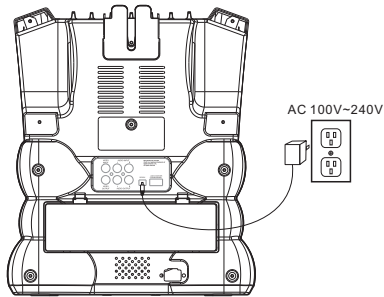

2. Load your disc;

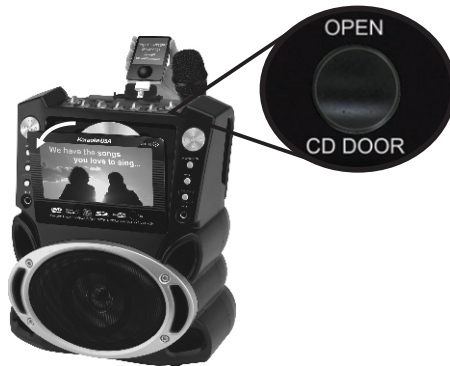

3. Close the CD door;



4. Turn on the unit (switch the unit to DISC/USB/SD mode) and select the "DISC" mode, the power indicator will light up;

5. Press **PLAY** to start your disc playing.

MP3G Disc and MP3G Format Music Playback

When an MP3G Disc, SD Card or USB device is connected, the screen will display as follows:

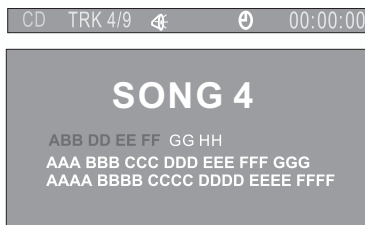
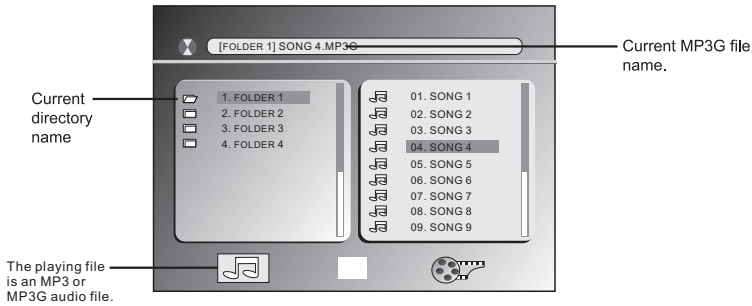

Press ▲ ▼ to select the file when the cursor appears in the file window.
Press select to play the current file select by the cursor.

Press ◀ ▶ to switch between the directory window and the file window.

Note: The player will not function correctly under the following condition:

1. The disc is badly scratched, damaged or dirty.
2. The disc is not finalized.
3. The recording format is not supported by the player.

Play SD Card and USB

Play Music

Before you do this, make sure you have download the music (MP3,MP3G format) to your SD card or USB. Plug the SD card or USB to the machine, Press "DISC/SD/USB" to select your desire device, Then the screen will shows:

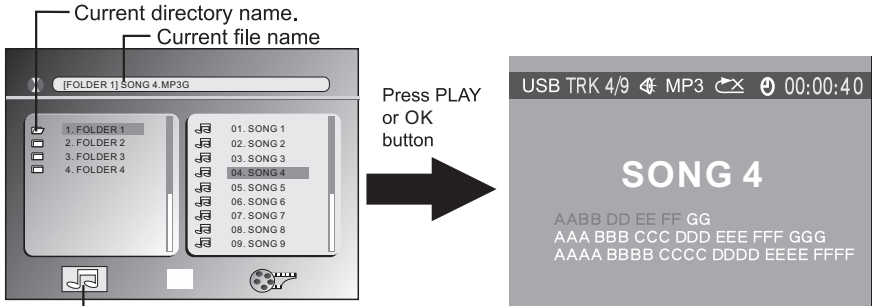

The frame shows it is in music mode.

- Press **▼ ▲** to select the file when the cursor appears in the file window.
- Press **OK** or **PLAY** to play the current file select by the cursor.
- Press **◀ ▶** to switch between the directory window and the file window.

View Photo

Before you do this, make sure you have download the image (JPG. format) to your SD card or USB (The operation same as "Play Music") . And the screen will shows:

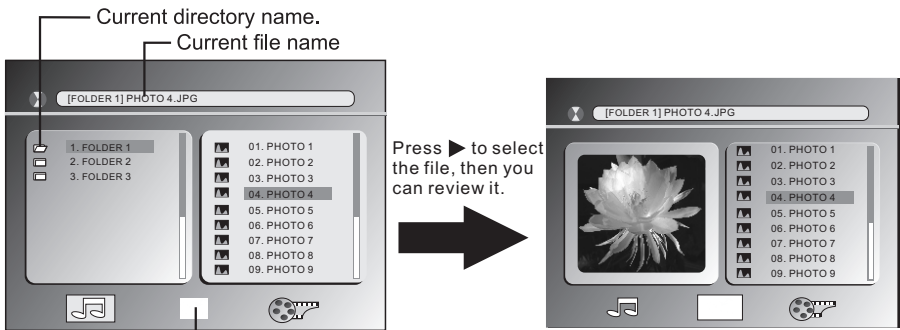

The frame shows it is in photo mode.



Play SD Card and USB

Watch Movie

Before you do this, make sure you have download the movie (AVI. format) to your SD card or USB (The operation same as “Play Music”). And the screen will shows:

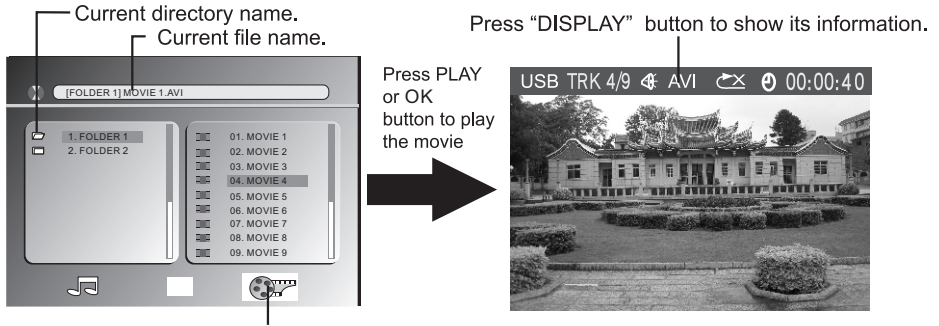

The frame shows it is in movie mode.

Record Operation Procedures

1. Load Disc, SD card or USB, select song Title from the song list and press PLAY, the unit plays. (This unit supports the MP3, MP3+G, CD, CD+G format's song.)
2. Press the red RECORD/STOP button --> screen shows " USB Ready or SD Card Ready".
3. User can start singing into the Microphone and record. When finished, Press RECORD/STOP to stop Recording.

When recording, the screen shows the below:

(In different disc format, recording picture is different on the screen.)

A. In MP3G mode:

①. Playing

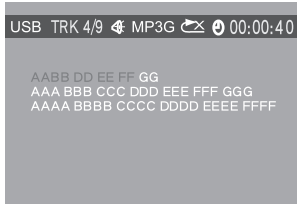

②. Recording

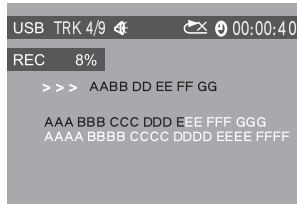

③. Recording finished



B. In CDG mode:

①. Playing



②. Recording

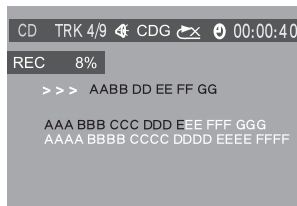

③. Recording finished

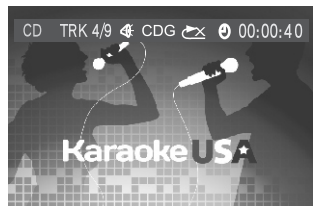

4. Press "RECORD PLAYBACK" to listen the song you just recorded.

Note:

not all USB stickers format the same way. Some USB stickers may not work properly, please try a different brand if you have record problem.

99 percent of the SD card are format and works good in this machine.

DVD format disc does not support the record function.

Playback the Recorded File

1. Press "RECORD PLAYBACK" **JUST RIGHT AFTER YOUR RECORDING.**
2. Press DISC/SD/USB button to select USB or SD mode.

A



- B. Select RECORD folder, then press OK.
--> Screen shows all tack No.

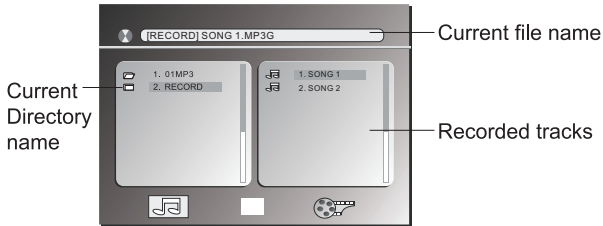

- C. Use the navigation buttons to pick the identical track number when the Song/Vocal was recorded, Press OK to play.

1. SYSTEM SETUP

The system setup options are illustrated as below:

1.1 TV SYSTEM

According to the Color System of the TV, you can choose the TV System.

1.2 SCREEN SAVER

The SCREEN SAVER function is automatically and always on; when the player is in STOP, after few minutes in Open or No disc state, it will appear a DVD logo moving around the screen.

1.3 TV TYPE

According to the TV type, you can choose 16:9,4:3LB or 4:3PS.

16:9 : The picture fills the screen of a wide screen TV.

4:3 PS : Pan and Scan, the image is cut in order to fit the whole screen.

4:3 LB: Letter box, two black bands will appear on the upper and lower part of the screen.

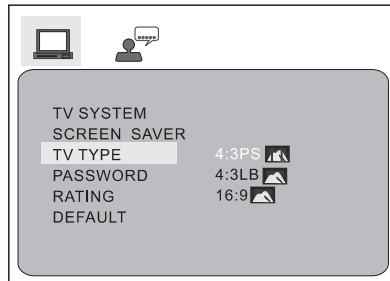

1.4 PASSWORD

The password option is initialized locked, and you can not set the ratings limit or change the password. In order to set the Ratings feature to work, the password mode must be turned on. If you want to set the ratings limit, you will need to enter the default password, which is 0000, then press OK to confirm. To change the password, you will be prompted for the old password, then be prompted for a new one. Enter a 4-digit number (this is your password). Press remember your PASSWORD, as the DEFAULT setting will revert everything.

1.5 RATING

The Rating feature is a rating limit system, like movie ratings. It works with DVD discs that have been assigned a rating. This helps you control the types for DVDs that your family watches.

1.6 DEFAULT

The DEFAULT setup options are RESTORE factory setup.

When your unit does not work properly, It may probably result from some wrong settings. Please try the Restore Factory Setting function to see if the unit can restore to its normal working status.

2. LANGUAGE SETUP

The language setup options are illustrated as below:

2.1 OSD LANGUAGE

Highlight the OSD LANGUAGE option, and press the Arrow buttons to choose the OSD language you prefer. Press OK to confirm, then the language will be set as OSD language.

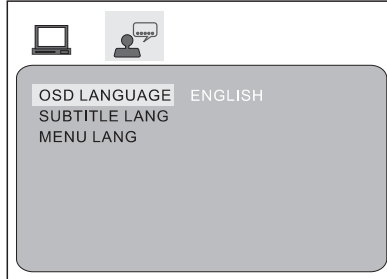

2.2 SUBTITLE LANG

Highlight the SUBTITLE LANG option, and press the Arrow buttons to choose the subtitle language you prefer. Press OK to confirm. If the disc you are playing has that language, it will display subtitles in that language.

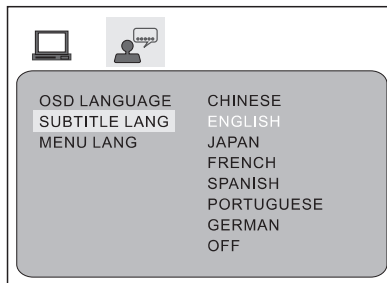

2.3 MENU LANG

Highlight the MENU LANG option, and press the Arrow buttons to choose the menu language you prefer. Press OK to confirm. If the disc you are playing has that Language, it will display the menu in the language.

Notes: If your preferred language is not available, the disc s default language will be played.

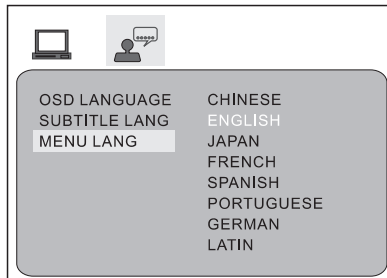

Specifications

Power requirements: DC12V

Power Consumption: 25W

Video standard: NTSC

Unit Weight: 3.7kg

Video output

1.0V(p-p)/ 75Ω, sync, negative polarity, RCA pin jack x 1

Audio output

2.0 channel output: RCA pin jack(L,R) x 2

Frequency response: 20Hz to 20kHz

S/N ratio: >90dB

Total harmonic distortion: <0.0025%

Accessories

DC Adapter x 1

RCA cables x 1

iPod® cable x 1

Remote Control x 1

User's Manual x 1

Warranty Card x 1

Holder for MP3/iPod® x 1

Demo Disc x 2

Microphone x 2

Troubleshooting

If you have any questions, please consult the troubleshooting guide below.

NO PICTURE OR SOUND

- Make sure the Power switch is ON.
- Ensure the power outlet is operational.
- Ensure the power cord is not damaged.
- Ensure the power plug is connected firmly to the outlet.

PICTURE BUT NO SOUND ON TV

- Ensure the audio jacks are securely connected.
- Ensure the audio connector is not damaged.
- Ensure the volume is turned up in setup.
- Ensure you have entered the correct AV input for your TV.
- Ensure the audio is not set to mute.

SOUND BUT NO PICTURE ON TV

- Ensure the video jacks are securely connected.
- Ensure you have entered the correct AV input for your TV.
- Ensure the video connector is not damaged.
- Ensure you have set the player's VIDEO settings correctly.

"NO DISC" DISPLAYED

- Ensure you have put the disc on the tray.
- Ensure the disc is not upside down.
- Ensure the disc is not distorted, stained or scratched.

SD CARD

* Use the SD Card which meets SD standards. If not, it may cause the Karaoke to malfunction.

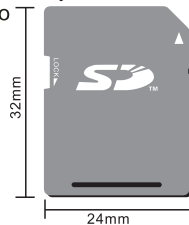

"BAD DISC" DISPLAYED

- Ensure the disc is not warped, damaged or deformed.
- Ensure the disc is not badly stained or damaged.
- Ensure the disc format is compatible with the player.
- Please check whether you have tried to play a software CD. If so, please restart the player.

REMOTE NOT WORKING

- Make sure the Main unit's POWER button is on.
- Ensure the remote batteries are working.
- Point the remote control directly at the player's IR sensor.
- Remove any obstacles between the remote and the IR sensor.

UNIT NOT WORKING

- Turn off the power, and then turn it on again.

SOUND BUT NO PICTURE ON TV

- Ensure you have selected the proper mode on the unit.
- Ensure you have download the proper format from the computer to your device.
- Some HC SD card or USB maynot compatible with this unit.

UNIT NOT WORKING

- Turn off the power, and then turn it on again.

* Gently insert the SD Card label surface facing front.

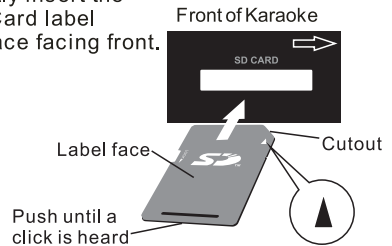

* Compliant card type: SDHC Card, SD Card, miniSD Card, miniSDHC Card, microSD Card, microSDHC Card (requiring miniSD Card/miniSDHC Card/microSD Card/microSDHC Card adapter)

* If a miniSD Card, miniSDHC Card, microSD Card or microSDHC Card is used, insert/remove it together with the adapter.

