

A black, textured fabric backpack with blue accents. The top flap is open, revealing a blue interior with a yellow and black patterned pouch containing various small items. A white cable is plugged into a port on the top left. The TYLT logo is printed in blue on the front panel. The background is a solid dark blue.

TYLT

BUILT TO TYLT

TYLT

ENERGI+ Power Backpack
with Built-in Battery

User Guide



ENG

ENERGI+ Power Backpack
with Built-in Battery

User Guide - Contents:

1	ENERGI+ Backpack	Page 01
2	Quick Start	Page 02
3	Charging Your Devices	Page 03
4	Battery Operation	Pages 04-05
5	Charging Zones	Page 06
6	NFC	Page 07

FRA

Sac à dos chargeur ENERG+
avec batterie intégrée

Manuel de l'utilisateur - Contents:

1	Sac à dos ENERG+	Page 08
2	Démarrage rapide	Page 09
3	Charger vos appareils	Page 10
4	Utilisation de la batterie	Pages 11-12
5	Zones de charge	Page 13
6	NFC	Page 14

ESP

Mochila para cargar dispositivos ENERG+
con batería incorporada

Guía de usuario - Contents:

1	Mochila ENERG+	Página 15
2	Guía de inicio rápido	Página 16
3	Carga de sus dispositivos	Página 17
4	Funcionamiento de la batería	Páginas 18 al 19
5	Zonas de carga	Página 20
6	NFC	Página 21

ITA

Zaino di ricarica ENERG+
con batteria incorporata

Manuale d'uso - Contents:

1	Zaino ENERG+	Pagina 22
2	Guida rapida	Pagina 23
3	Ricarica dei dispositivi	Pagina 24
4	Funzionamento della batteria	Pagine 25-26
5	Zone di ricarica	Pagina 27
6	NFC	Pagina 28

DEU

ENERGI+ Power Backpack
mit integriertem Akku

Bedienungsanleitung - Contents:

1	ENERGI+ Backpack	Seite 29
2	Kurzanleitung	Seite 30
3	Geräte laden	Seite 31
4	Akkubetrieb	Seiten 32-33
5	Ladezonen	Seite 34
6	NFC	Seite 35

PRT

Mochila carregadora ENERG+
com bateria integrada

Guia do utilizador - Contents:

1	Mochila ENERG+	Página 36
2	Início rápido	Página 37
3	Carregar os seus dispositivos	Página 38
4	Funcionamento da bateria	Páginas 39-40
5	Zonas de carregamento	Página 41
6	NFC	Página 42

ENG ENERGI+ BACKPACK

- 1 Accessory Bag
- 2 Main Compartment
- 3 Protect Pocket™
- 4 Tablet Compartment
- 5 Laptop / Battery Compartment
- 6 Headphone Pass-Through
- 7 Charging Pass-Through
- 8 Battery Recharge Cable Pocket
- 9 Hydration Pocket
- 10 Trolley Pass Through
- 11 Built-in TYLT TAGZ™ NFC 
- 12 Headphone Pocket
- 13 Charging Pass-Through

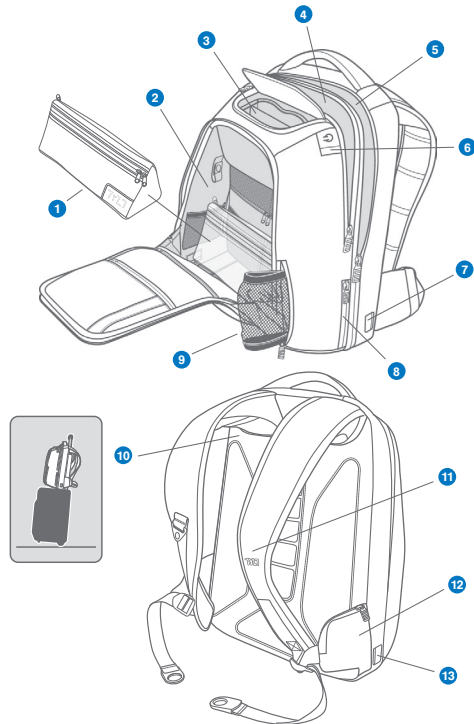

QUICK START

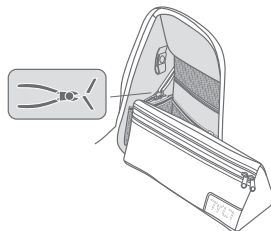

1. Cut security ties from Accessory Bag and remove battery and cables.

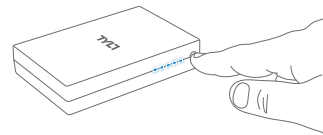

2. Press and release battery power button.

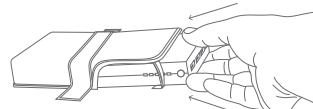

3. Place battery in charging pouch.

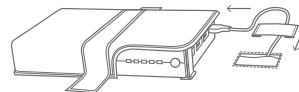

4. Connect micro-USB Charging cable to battery. Feed excess cable into Battery Recharge Cable Pocket.

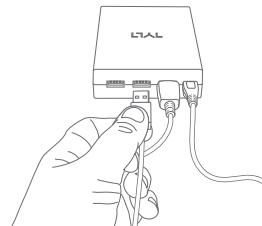

5. Connect device charging cables to battery. Use the cables included or any other USB cable you may have.

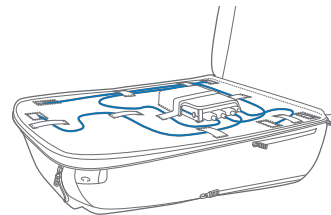

6. Route cables and connect your devices.

Scan this code for the most up-to-date product information.
www.TYLT.com



3 CHARGING YOUR DEVICES

Choose the cable which is compatible with your device. The TYLT® ENERGI Battery Pack will work with the included cables or any other USB cable you may have on hand.

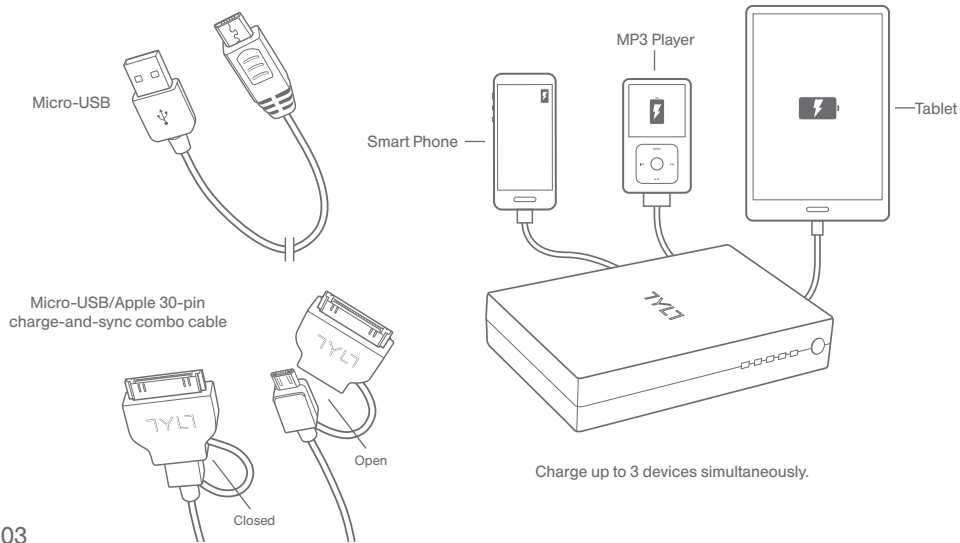

4 BATTERY OPERATION

>>POWERING ON AND OFF

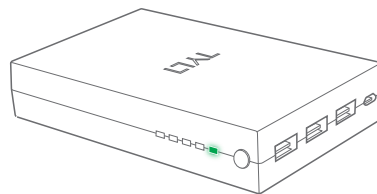

Powering ON

Press power button once to power on. The blue battery capacity indicator lights will show status, then green light will indicate battery is ON.

Powering OFF

Press and hold power button for 3 seconds. Blue indicator lights will blink 3 times, then all lights will turn off, indicating battery is OFF. To preserve battery life, ENERGI will automatically power off after 10 minutes without device charging.

>>CHECKING BATTERY CAPACITY

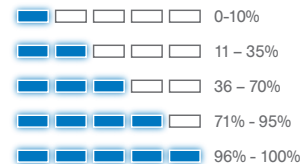
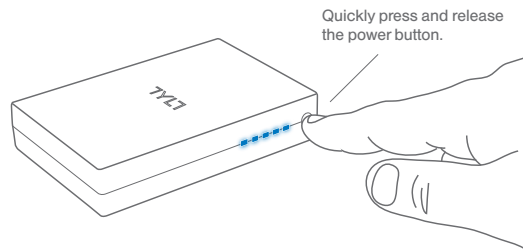

Battery capacity indicator lights show remaining charge.

>>RECHARGING THE ENERGI BATTERY

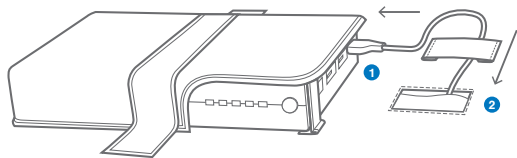

- 1 Plug the micro USB charging cable into the ENERGI battery.
- 2 Route the other end of the cord to the Battery Recharge Cable Pocket. Plug into any available USB port to charge.

During charging, the LED capacity lights will indicate charge status.
A SINGLE GREEN LED MEANS THAT CHARGING IS COMPLETE.

The ENERGI battery will fully recharge from empty in 7-8 hours using a 2 Amp USB charging source.

When recharging the ENERGI battery, devices will start charging once the ENERGI battery is charged to 50%

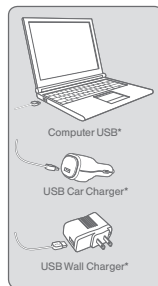

* Not included



5 CHARGING ZONES

>>ROUTING YOUR CABLES

Pass-through openings allow cable access to different charging zones.

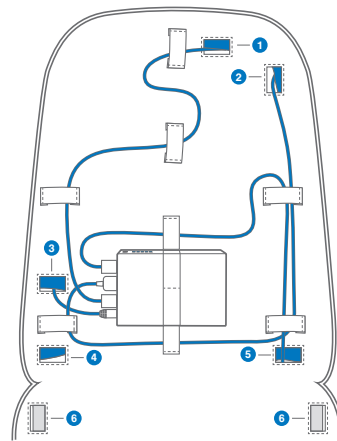

- 1 Tablet Compartment
- 2 Protect Pocket™
- 3 Charging Cord Pocket
- 4 Main Compartment
- 5 Main Compartment
- 6 Outside the Backpack



Tablet / iPad compartment

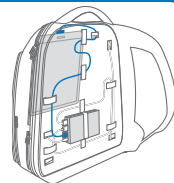

Protect Pocket™

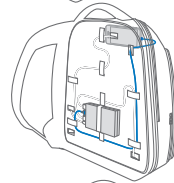

Large Main Compartment and Side Charging Pocket

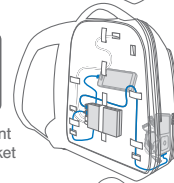

Outside device charging



6 NFC

ENERGI+ is equipped with a TYLT TAGZ™ programmable NFC Tag that can interact with your NFC-enabled device. With a single tap you can customize settings and launch Apps.

EASY TO USE

- 1) Check to see if your device is NFC-enabled and that NFC is turned on in device settings. If so, just tap your device to the TYLT logo on the backpack strap to install your free NFC Task Launcher App, or search for NFC Task Launcher at the Play Store.
- 2) Launch the NFC Task Launcher App.
- 3) Follow on-screen instructions to set up your TAGZ NFC.



For detailed instructions visit:
<http://launcher.tagstand.com>

SPECIFICATIONS

BACKPACK

Dimensions 11.5in x 13.5in x 19in

Weight: 3.8 lbs.

Fits laptops up to 15.5in x 10.5in x 1.5in

Fits tablets up to 10.5in x 8in x 0.5in

BATTERY

10,400mAh Lithium Ion

5V 4.1A Output

5V 2A Input

3 USB Charging Outputs (1x2.1A/2x1A)

Dimensions 4.625in x 3.125in x 0.825in

Weight: 11.1 oz.

WARNING:

Do not disassemble.

Do not immerse in water.

Do not store near a heat source above 120°F.

Do not short circuit.

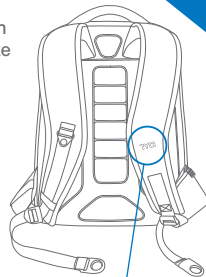

NFC-Located in
Shoulder Strap

NFC ENABLED
TYLT Products
N

1

FRA

SAC A DOS ENERGI+

- 1 Sac d'accessoires
- 2 Compartiment principal
- 3 Protect Pocket™
- 4 Compartiment pour tablette
- 5 Compartiment pour ordinateur portable / batterie
- 6 Passage pour le casque
- 7 Passage pour le câble de charge
- 8 Poche pour le câble de recharge de la batterie
- 9 Poche pour l'eau
- 10 Passage pour la poignée télescopique des valises
- 11 TYLT TAGZ™ NFC intégré 
- 12 Poche pour le casque
- 13 Passage pour le câble de charge

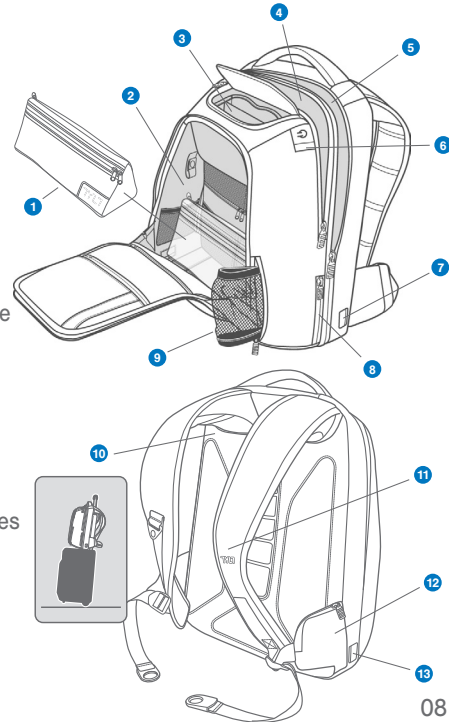

2 DEMARRAGE RAPIDE

Scannez ce code pour
obtenir les dernières
informations sur le produit.
www.TYLT.com

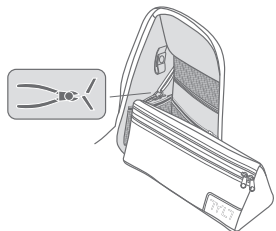

1. Découpez les attaches de sécurité du sac d'accessoires et enlevez la batterie et les câbles.

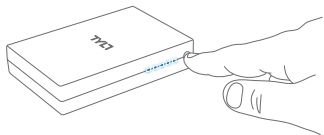

2. Appuyez sur le bouton d'alimentation de la batterie puis relâchez-le.

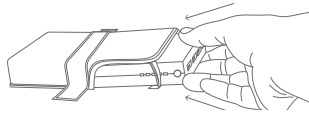

3. Placez la batterie dans la poche de charge.

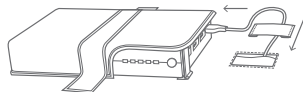

4. Connectez le câble de charge micro-USB à la batterie. Rangez le câble en trop dans la poche du câble de recharge de la batterie.

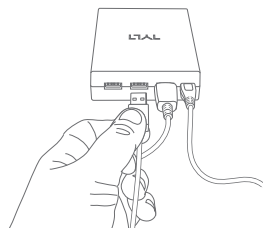

5. Connectez les câbles de charge des différents appareils à la batterie. Utilisez les câbles inclus ou n'importe quel câble USB à votre disposition.

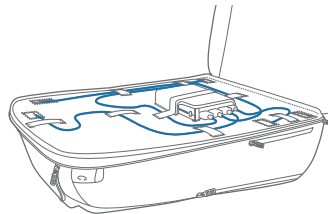

6. Faites passer les câbles dans les différentes bandes et connectez vos appareils.

3 CHARGER VOS APPAREILS

Choisissez le câble compatible avec votre appareil. La batterie TYLT® ENERGI fonctionnera avec les câbles compris ou n'importe quel câble USB dont vous pourriez disposer.

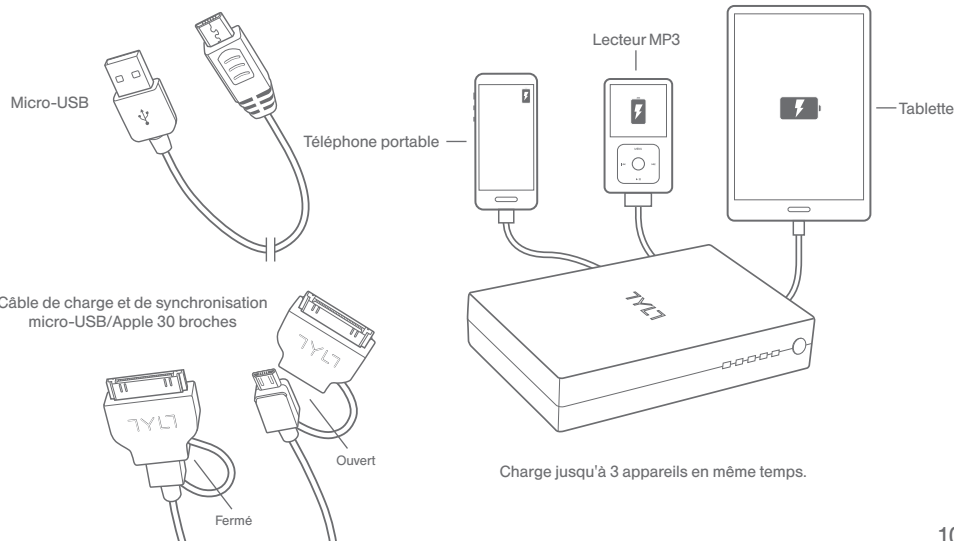

UTILISATION DE LA BATTERIE

>> ALLUMER ET ETEINDRE

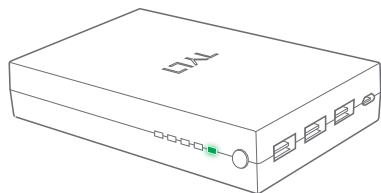

Allumer (ON)

Appuyez une fois sur le bouton d'alimentation pour allumer la batterie. Les indicateurs lumineux bleus montrent la charge de la batterie et la lumière verte indique que la batterie est allumée.

Eteindre (OFF)

Appuyez sur le bouton d'alimentation et maintenez-le enfoncé pendant 3 secondes. Les indicateurs lumineux bleus clignoteront trois fois puis toutes les lumières s'éteindront pour indiquer que la batterie est éteinte.

Pour préserver la charge de la batterie, ENERGI s'éteindra automatiquement au bout de 10 minutes sans charge d'appareils.

>> VERIFIER LA CHARGE DE LA BATTERIE

Appuyez rapidement sur le bouton d'alimentation puis relâchez-le.

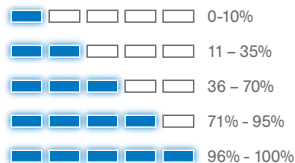
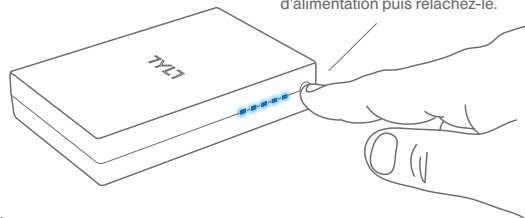

Les indicateurs lumineux montrent la charge restante sur la batterie.

>> RECHARGER LA BATTERIE ENERGI

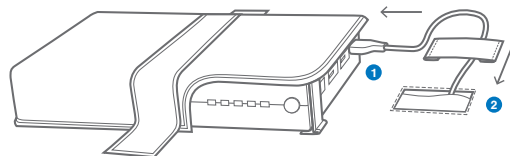

- 1 Branchez le câble de charge micro-USB dans la batterie ENERGI.
- 2 Rentrez l'autre extrémité du câble dans la poche du câble de charge de la batterie. Branchez la prise dans n'importe quel port USB pour charger la batterie.

Pendant la charge, les LED montreront l'état de la charge.

UNE SEULE LUMIERE VERTE SIGNIFIE QUE LA CHARGE EST TERMINEE.

Il faut 7-8 heures sur une source de charge USB 2 A pour recharger complètement une batterie ENERGI vide.

En mode recharge, la batterie ENERGI commencera à charger des appareils dès qu'elle sera à rechargée à 50%.

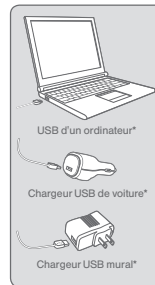

*Non compris

5 ZONES DE CHARGE

>>FAITES PASSER VOS CÂBLES

Les passages permettent aux câbles d'accéder aux différentes zones de charge.

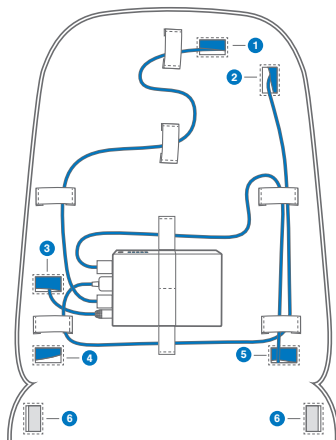

- 1 Compartiment pour tablette
- 2 Protect Pocket™
- 3 Poche du câble de charge
- 4 Compartiment principal
- 5 Compartiment principal
- 6 Extérieur du sac à dos



Compartiment pour tablette / iPad



Protect Pocket™



Grand compartiment principal et poche de charge latérale



Charge d'un appareil à l'extérieur du sac à dos

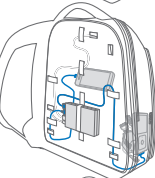
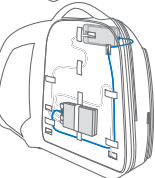
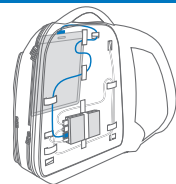

6 NFC

ENERGI+ est doté d'une étiquette NFC TYLT TAGZ™ programmable capable d'interagir avec votre appareil NFC. Un simple contact vous permet de personnaliser les paramètres et de lancer des applications.

FACILE D'UTILISATION

- 1) Vérifiez si votre appareil est compatible NFC et que le NFC soit activé dans les paramètres de l'appareil. Si c'est le cas, il vous suffit de toucher le logo TYLT situé sur la bretelle du sac à dos pour installer l'application gratuite NFC Task Launcher ou de rechercher NFC Task Launcher dans le Play Store.
- 2) Lancez l'application NFC Task Launcher.
- 3) Suivez les instructions à l'écran pour configurer votre TAGZ NFC.



Pour des instructions détaillées:
<http://launcher.tagstand.com>

CARACTERISTIQUES

SAC A DOS

Dimensions 29,21 x 34,29 x 48,26 cm

Poids : 1,72 kg

Compatible avec les ordinateurs portables d'au max. 39,37 x 26,67 x 3,81 cm

Compatible avec les tablettes d'au max. 26,67 x 20,32 x 1,27 cm

BATTERIE

Ions lithium 10 400 mAh

Sortie 5 V 4.1 A

Entrée 5 V 2 A

3 sorties de charge USB (1 x 2.1 A / 2 x 1A)

Dimensions 11,75 x 7,94 x 2,10 cm

Poids : 0,31 kg

COMPATIBLE NFC

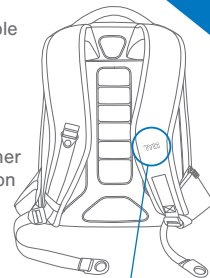

NFC situé sur la bretelle du sac à dos

AVERTISSEMENT:

Ne pas le démonter.

Ne pas le plonger dans l'eau.

Ne pas le ranger près d'une source de chaleur de plus de 49°C.

Ne pas le court-circuiter.

ESP MOCHILA ENERGI+

- 1 Estuche para accesorios
- 2 Compartimiento principal
- 3 Protect Pocket™
- 4 Compartimiento para tableta
- 5 Compartimiento para batería / ordenador portátil
- 6 Sistema de acceso para los auriculares
- 7 Sistema de acceso para fines de carga
- 8 Bolsillo para el cable de recarga de la batería
- 9 Bolsillo para llevar agua
- 10 Sistema de acople para trolley
- 11 TAGZ™ NFC incorporado de TYLT 
- 12 Bolsillo para auriculares
- 13 Sistema de acceso para fines de carga

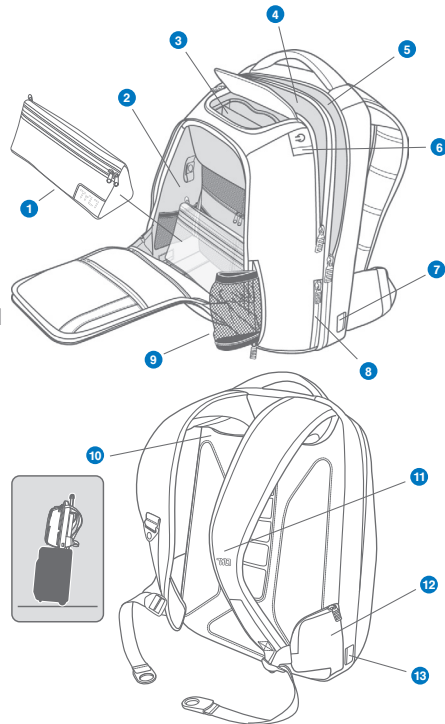

GUÍA DE INICIO RÁPIDO



Escanee este código para obtener la información más actualizada sobre el producto.
www.TYLT.com

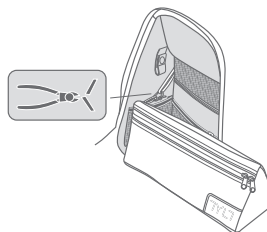

1. Corte las trabas de seguridad del estuche para accesorios y saque la batería y los cables.

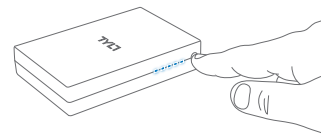

2. Pulse y suelte el botón de encendido de la batería.

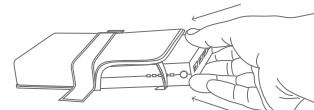

3. Coloque la batería en el estuche de carga.

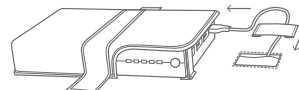

4. Conecte el cable de carga micro-USB a la batería. Coloque el exceso de cable en el bolsillo del cable de recarga.

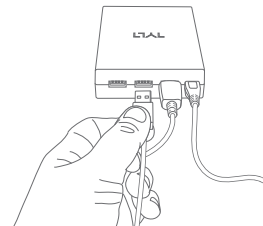

5. Conecte los cables de carga de los dispositivos a la batería. Utilice los cables provistos o cualquier otro cable USB que tenga a la mano.

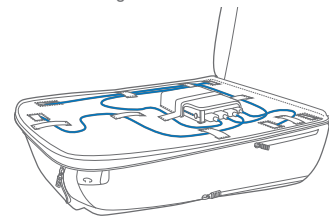

6. Organice los cables y conecte sus dispositivos.

3 CARGA DE SUS DISPOSITIVOS

Seleccione el cable que es compatible con su dispositivo. La batería ENERGI de TYLT® funcionará con los cables incluidos o con otros cables USB que tenga a la mano.

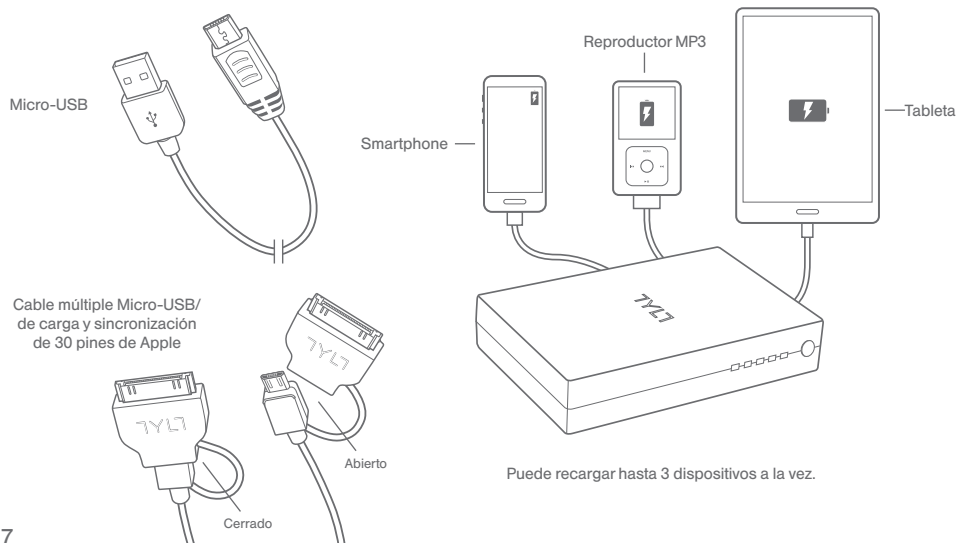

4 FUNCIONAMIENTO DE LA BATERÍA

>> ENCENDER Y APAGAR

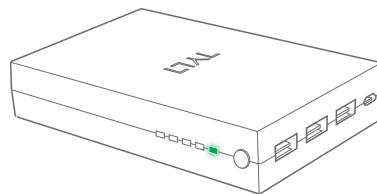

ENCENDER (ON)

Para encender pulse el botón de encendido. La luz azul indicadora de la capacidad de la batería mostrará el estado de la batería, y luego la luz verde indicará que la batería está ENCENDIDA.

APAGAR (OFF)

Pulse y mantenga presionado el botón de encendido por unos 3 segundos. Las luces de estado azules parpadearán 3 veces y luego se apagará para indicar que la batería está APAGADA. Para preservar la duración de la carga de la batería, ENERGI se apagará automáticamente si no se efectúa la carga de un dispositivo por un periodo de 10 minutos.

>> REVISIÓN DE LA CAPACIDAD DE LA BATERÍA

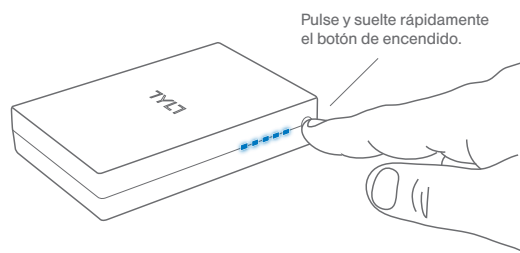

Pulse y suelte rápidamente el botón de encendido.

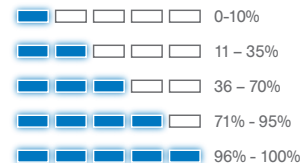

Las luces indicadoras de la capacidad de la batería mostrarán el nivel de carga restante.

>>CARGA DE LA BATERÍA ENERGI

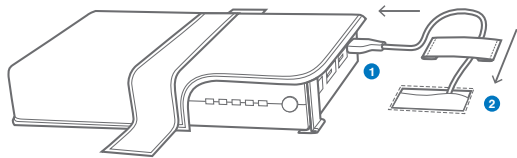

- 1 Conecte el cable de carga micro USB a la batería ENERGI.
- 2 Coloque el otro extremo del cable hacia el bolsillo del cable de recarga de la batería. Para cargar conecte a cualquier puerto USB disponible.

Durante la carga, las luces LED indicarán el estado de la carga.

UNA SOLA LUZ LED VERDE SIGNIFICA QUE SE HA COMPLETADO LA CARGA.

La batería ENERGI, totalmente vacía, se recargará totalmente en 7-8 horas a través de una fuente de carga USB de 2 Amp.

Al recargar la batería ENERGI, los dispositivos empezarán a cargarse una vez que la batería ENERGI está cargada al 50%.

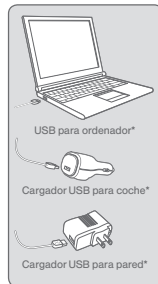

USB para ordenador*

Cargador USB para coche*

Cargador USB para pared*

*No incluido.



5 ZONAS DE CARGA

>>ENRUTAMIENTO DE SUS CABLES

Los sistemas de acceso con abertura permiten el acceso de cables a diferentes zonas de recarga.

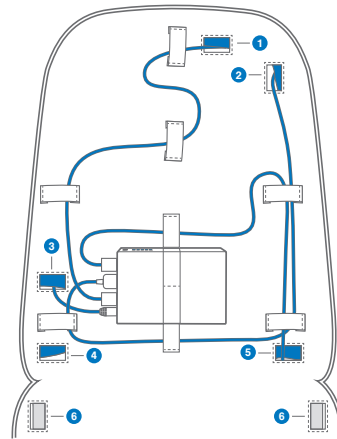

- 1 Compartimento para la tableta
- 2 Protect Pocket™
- 3 Bolsillo para el cable de recarga
- 4 Compartimento principal
- 5 Compartimento principal
- 6 Afuera de la mochila



Compartimento para la tableta o iPad



Protect Pocket™



Compartimento principal grande y bolsillo lateral de carga



Carga de un dispositivo externo

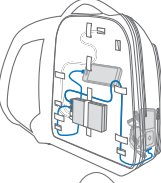
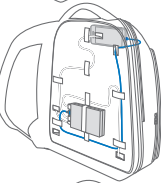
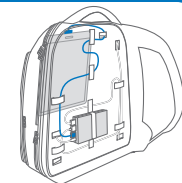

6 NFC

ENERGI+ está dotado de un tag o etiqueta inteligente programable con tecnología NFC TYLT TAGZ™ que puede interactuar con su dispositivo NFC. Con un simple toque puede personalizar sus ajustes e iniciar aplicaciones.

FÁCIL DE UTILIZAR

- 1) Compruebe que su dispositivo tiene NFC y vaya a los ajustes de su dispositivo para comprobar que la función NFC esté activada. De ser así, simplemente acerque su dispositivo al logo TYLT situado en la correa de la mochila a fin de instalar gratis su aplicación NFC Task Launcher o buscar dicha aplicación en su tienda de descargas Play Store.
- 2) Inicie la aplicación NFC Task Launcher.
- 3) Siga las instrucciones que aparecen en la pantalla a fin de configurar su TAGZ NFC.



Para obtener más información sobre las instrucciones, visite: <http://launcher.tagstand.com>

ESPECIFICACIONES

MOCHILA

Dimensiones: 29,21 cm x 34,29 cm x 48,26 cm
Peso: 1,72 kg
Compatible con ordenadores portátiles de hasta 39,37 cm x 26,67 cm x 3,81 cm
Compatible con tabletas de hasta 26,67 cm x 20,32 cm x 1,27 cm

BATERÍA

Ion de litio de 10.400 mAh
Salida de 5V 4,1A
Entrada de 5V 2A
3 puertos USB para fines de carga (1x2,1A/2x1A)
Dimensiones: 11,75 cm x 7,94 cm x 2,10 cm
Peso: 0,31 kg

AVISO:

No lo desmonte.
No lo sumerja en agua.
No lo almacene cerca de una fuente de calor por encima de 49 °C.
No provoque corto circuitos

COMPATIBLE CON NFC

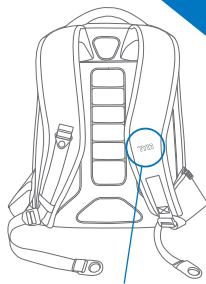

La función NFC está situada en la correa de la mochila

1

ITA

ZAINO DI RICARICA ENERGI+

- 1) Tasca porta accessori
- 2) Comparto principale
- 3) Protect Pocket™
- 4) Comparto tablet
- 5) Comparto computer portatile/batteria
- 6) Passante per auricolari
- 7) Passante per cavo di ricarica
- 8) Tasca per cavo di ricarica batteria
- 9) Tasca porta bottiglie
- 10) Passante per trolley
- 11) Chip NFC TYLT TAGZ™ integrato
- 12) Tasca per auricolari
- 13) Passante per cavo di ricarica

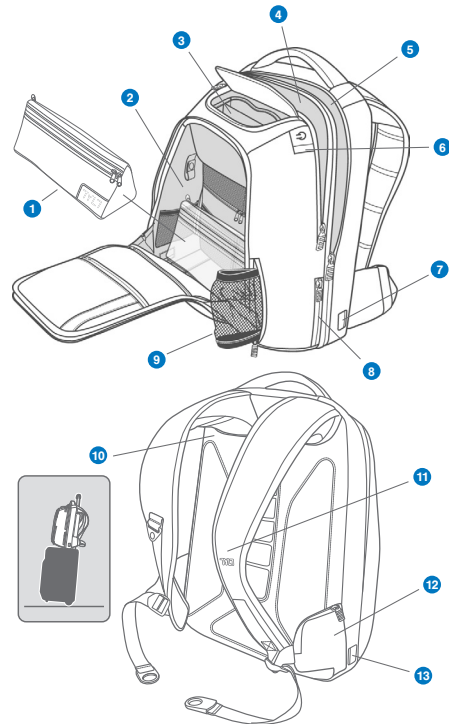

2 AVVIO RAPIDO

Codice da scansionare per accedere alle informazioni più recenti sul prodotto.
www.TYLT.com

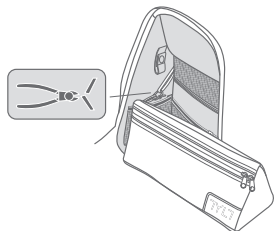

1. Tagliare i laccetti di sicurezza dalla borsa porta accessori ed estrarre la batteria e i cavi.

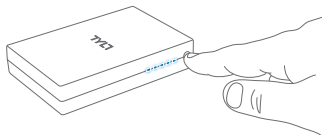

2. Premere e rilasciare il pulsante di accensione della batteria.

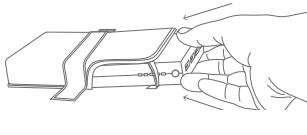

3. Inserire la batteria nel marsupio di ricarica.

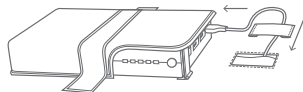

4. Collegare il cavo di ricarica micro USB alla batteria. Infilare il cavo in eccesso nella tasca del cavo di ricarica batteria.

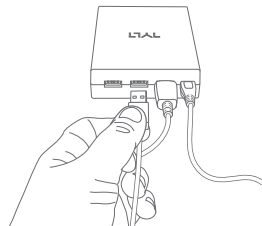

5. Collegare i cavi di ricarica del dispositivo alla batteria. Utilizzare i cavi forniti o qualsiasi altro cavo USB che si possiede.

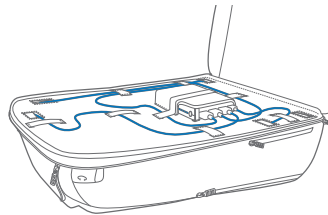

6. Indirizzare i cavi e collegare i propri dispositivi.

3 RICARICA DEI DISPOSITIVI

Scegliere il cavo compatibile con il proprio dispositivo. La batteria TYLT® ENERGI è compatibile con i cavi forniti o qualsiasi altro cavo USB eventualmente disponibile.

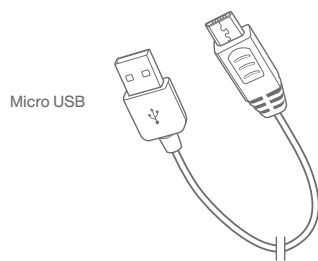

Micro USB

Micro USB per dispositivi Apple a 30 pin Cavo di ricarica e sincronizzazione

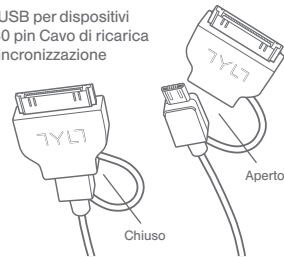

Chiuso

Smartphone

Letto MP3

Tablet

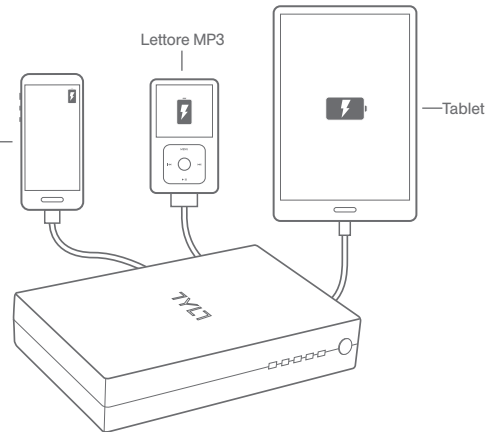

Può ricaricare fino a 3 dispositivi contemporaneamente.

FUNZIONAMENTO DELLA BATTERIA

>>ACCENSIONE E SPEGNIMENTO

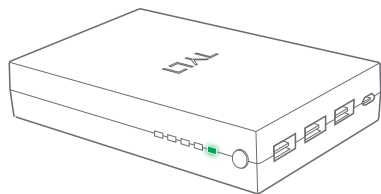

Accensione

Per l'accensione, premere il rispettivo pulsante una volta. La spia blu di carica della batteria visualizza lo stato, la spia verde indica che la batteria è ACCESA.

Spegnimento

Tenere premuto il pulsante di accensione per 3 secondi. Le spie blu lampeggiano 3 volte, dopodiché tutte le spie si spengono per indicare che la batteria è SPENTA. Per preservare la durata della batteria, il dispositivo ENERG I si spegnerà automaticamente dopo 10 minuti trascorsi senza effettuare la ricarica.

>>VERIFICA DELLA CAPACITÀ DELLA BATTERIA

Premere e rilasciare rapidamente il pulsante di accensione.

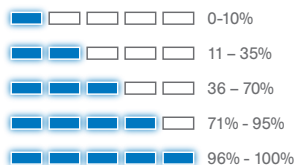
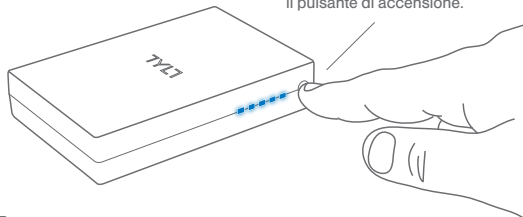

La spie di capacità della batteria indicano la carica residua.

>>RICARICA DELLA BATTERIA ENERG I

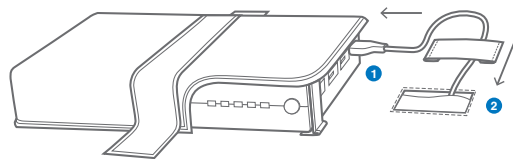

- 1 Collegare il cavo di ricarica micro USB alla batteria ENERG I.
- 2 Far passare l'altra estremità del cavo nella tasca del cavo di ricarica batteria. Per procedere con la ricarica, collegarlo a qualsiasi presa USB libera.

Durante la ricarica, i LED di capacità indicano lo stato di ricarica.
UN LED VERDE SINGOLO INDICA LA CONCLUSIONE DEL PROCESSO DI RICARICA.

Il caricabatteria ENERG I effettua la ricarica completa di una batteria completamente scarica in 7-8 ore utilizzando una sorgente di ricarica USB da 2 ampere.

Durante la ricarica della batteria ENERG I, i dispositivi inizieranno a ricaricarsi a partire da quando la batteria ENERG I avrà il 50% di ricarica.

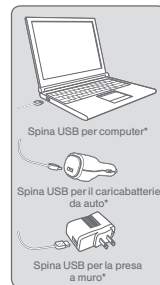

Spina USB per computer*

Spina USB per il caricabatterie da auto*

Spina USB per la presa a muro*

*Non compresa nella fornitura

5 ZONE DI RICARICA

>>COME INDIRIZZARE I CAVI

I fori passanti consentono al cavo di accedere alle varie zone di ricarica

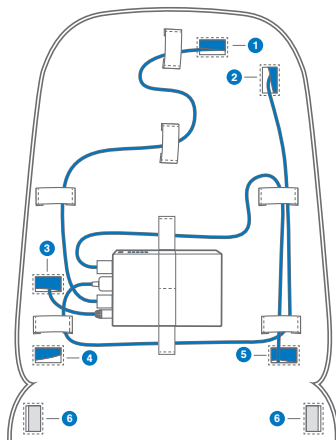

- 1 Comparto tablet
- 2 Protect Pocket™
- 3 Tasca per cavo di ricarica
- 4 Comparto principale
- 5 Comparto principale
- 6 Esterno dello zaino



Comparto tablet/iPad



Protect Pocket™



Ampio comparto principale e tasca di ricarica laterale



Ricarica del dispositivo esterno

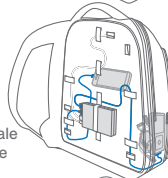
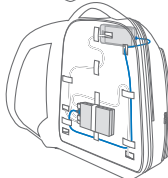
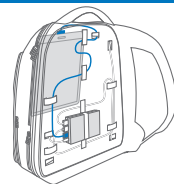

6 NFC

ENERGI+ è dotato di un chip NFC TYLT TAGZ™ programmabile in grado di interagire con il tuo dispositivo compatibile con la tecnologia NFC. Con un semplice tocco puoi personalizzare le impostazioni e lanciare le applicazioni che desideri.

FACILITÀ DI UTILIZZO

- 1) Accertarsi che il proprio dispositivo sia compatibile con la tecnologia NFC e che il chip NFC sia attivato nelle impostazioni del dispositivo. In tal caso, è sufficiente sfiorare il dispositivo sul logo TYLT sulla spalliera dello zaino per installare l'applicazione gratuita NFC Task Launcher oppure cercare il NFC Task Launcher nel Play Store.
- 2) Lanciare l'App NFC Task Launcher.
- 3) Seguire le istruzioni nello schermo per configurare il proprio TAGZ NFC.



Per informazioni più precise, visitare il sito <http://launcher.tagstand.com>

SPECIFICHE

ZAINO

Dimensioni 29,21 x 34,29 x 48,26 cm

Peso 1,72 kg.

Adatto a computer portatili fino a 39,37 x 26,67 x 3,81 cm

Adatto a tablet fino a 26,67 x 20,32 x 1,27 cm

BATTERIA

10.400 mAh agli ioni di litio

Uscita da 5V 4,1 A

Ingresso da 5V 2A

3 uscite di ricarica USB (1x2,1A/2x1A)

Dimensioni 11,75 x 7,94 x 2,10 cm

Peso 0,31 kg

COMPATIBILE NFC

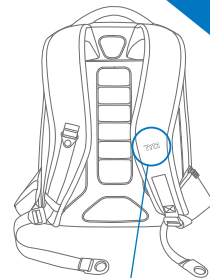

NFC posizionato sulla spalliera dello zaino

AVVERTENZA:

- Non smontare.
- Non immergere in acqua.
- Non conservare vicino a fonti di calore superiori ai 49° C.
- Non cortocircuitare.

DEU ENERGI+ BACKPACK

- 1 Zubehörtasche
- 2 Hauptfach
- 3 Protect Pocket™
- 4 Tablet-Fach
- 5 Laptop-/ Akkufach
- 6 Kopfhörer-Durchführung
- 7 Ladedurchführung
- 8 Akku-Ladekabeltasche
- 9 Getränketasche
- 10 Trolly-Durchführung
- 11 Integrierter TYLT TAGZ™ NFC-Chip 
- 12 Kopfhörertasche
- 13 Ladedurchführung

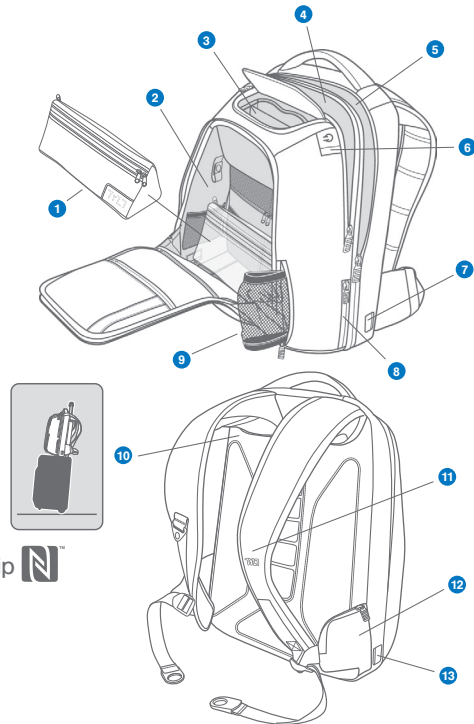

KURZANLEITUNG

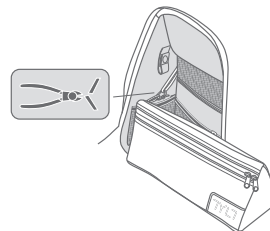

1. Befestigungsbänder an Zubehörtasche durchschneiden und Akku und Kabel entnehmen

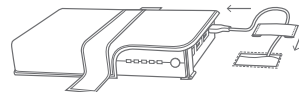

4. Mikro-USB-Ladekabel an Akku anschließen. Überschüssiges Kabel in Akku-Ladekabeltasche verstauen

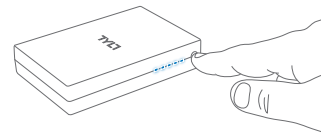

2. Akkuladetaste kurz drücken

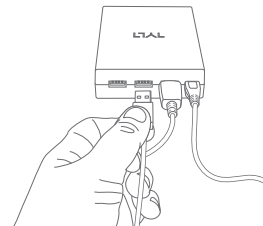

5. Geräteladekabel an Akku anschließen. Hierzu enthaltene oder vorhandene USB-Kabel verwenden.

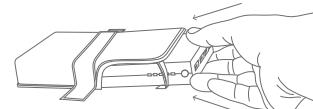

3. Akku in Ladetasche einlegen

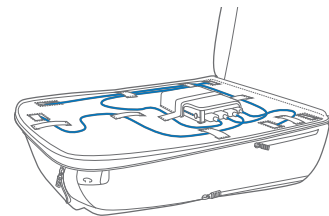

6. Kabel verlegen und an die Geräte anschließen.

Diesen Code für brandaktuelle
Produktinfo scannen.
www.TYLT.com



3 GERÄTE LADEN

Wählen Sie das für Ihr Gerät geeignete Kabel. Das TYLT® ENERGI Battery Pack kann mit den enthaltenen Kabeln oder einem anderen USB-Kabel genutzt werden, das Sie gerade zur Hand haben.

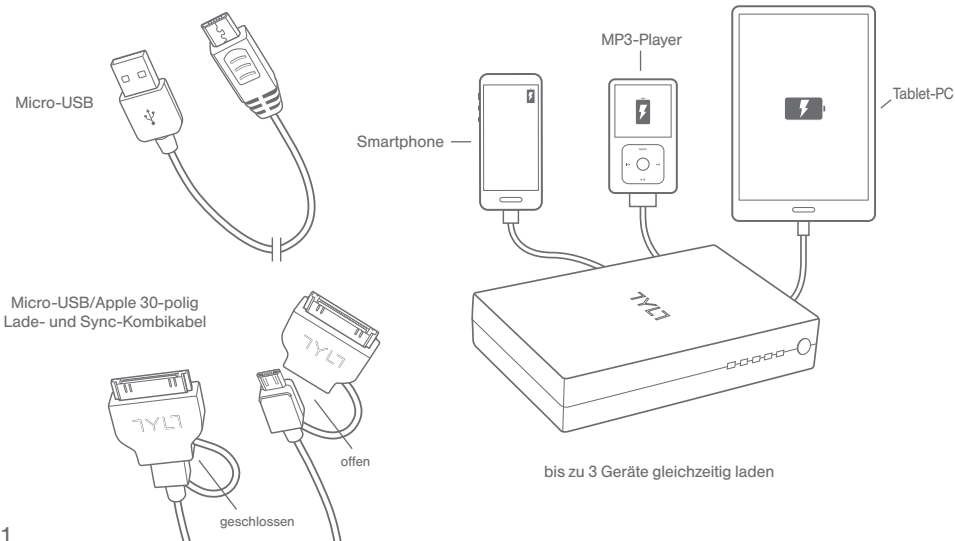

4 AKKUBETRIEB

>> EIN- UND AUSSCHALTEN

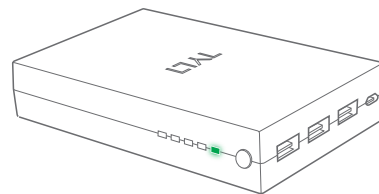

Einschalten

Zum Einschalten Betriebsstaste einmal drücken. Die blaue Ladestandanzeige zeigt den Akkustand an, die grüne Anzeige, dass der Akku eingeschaltet ist.

Ausschalten

Betriebsstaste 3 Sekunden lang gedrückt halten. Die blaue Anzeige blinkt 3 mal auf, dann schalten sich alle Anzeigen ab. Jetzt ist der Akku AUS. Zur Verlängerung der Akkuliebensdauer schaltet sich ENERGI nach 10 Minuten ohne Geräteladung automatisch ab.

>> AKKUSTAND PRÜFEN

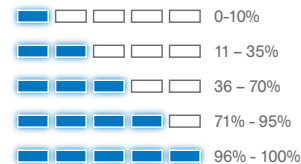
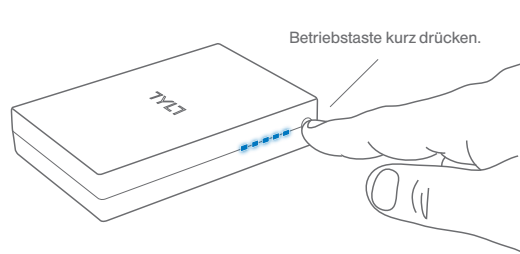

Akkuladestandanzeige zeigt verbleibende Ladung an.

>>ENERGI AKKU WIEDERAUFLADEN

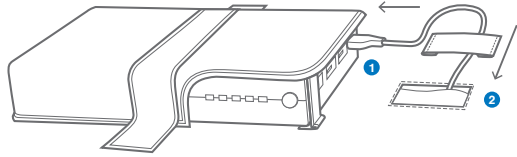

- 1 Schließen Sie das Micro-USB-Kabel an den ENERGI-Akku an.
- 2 Führen Sie das Kabel durch die Akku-Ladekabeltasche. Schließen Sie es zum Laden an eine freie USB-Schnittstelle an.

Während des Ladens zeigen die Ladestand-LEDs den Ladestand an.
Eine einzelne grüne LED bedeutet, dass der Ladevorgang abgeschlossen ist.

Der leere ENERGI Akku kann mit einer 2 A USB-Ladequelle innerhalb von 7-8 Stunden vollständig geladen werden.

Beim Laden des ENERGI-Akkus beginnt der Ladevorgang der Geräte, wenn der ENERGI-Akku mindestens 50% geladen ist.

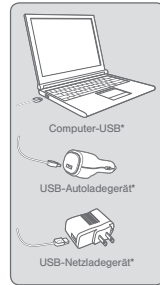

*Nicht enthalten



5 LADEZONEN

>>KABELFÜHRUNG

Durchführungen ermöglichen einen Kabelzugang zu unterschiedlichen Ladezonen.

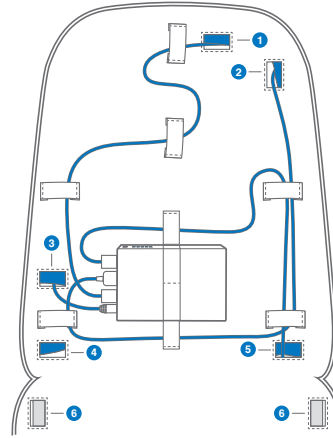

- 1 Tablet-Fach
- 2 Protect Pocket™
- 3 Ladekabeltasche
- 4 Hauptfach
- 5 Hauptfach
- 6 Rucksack-Ausgang



Tablet-/ iPad-Fach

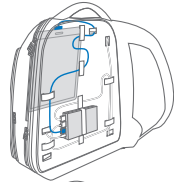

Protect Pocket™

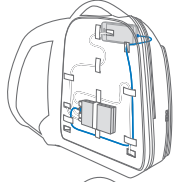

Großes Hauptfach und seitliche Ladetasche

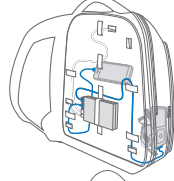

Externes Gerät laden



6 NFC

ENERGI+ ist mit einem integrierten programmierbaren TYLT TAGZ™ NFC-Tag ausgestattet, das mit einem NFC-fähigen Gerät kommunizieren kann. Mit einem einzigen Fingertipp können Sie individuelle Einstellungen vornehmen und Apps starten.

EINFACHE BEDIENUNG

- 1) Überprüfen Sie, ob Ihr Gerät NFC-fähig und NFC in den Geräteeinstellungen aktiviert ist. Ist dies der Fall, berühren Sie mit dem Gerät das TYLT-Logo auf dem Rucksack-Gurt, um die kostenlose NFC Task Launcher-App zu laden, oder suchen Sie im Play Store nach dem NFC Task Launcher.
- 2) Starten Sie die App NFC Task Launcher.
- 3) Folgen Sie den Display-Anweisungen zur Einrichtung des TAGZ NFC.



Umfassende Anweisungen finden Sie unter:
<http://launcher.tagstand.com>

TECHNISCHE DATEN

BACKPACK

Abmessungen: 29,21 x 34,29 x 48,26 cm

Gewicht: 1.72 kg

Passend für Laptops bis zu 39,37 x 26,67 x 3,81 cm

Passend für Laptops bis zu 26,6 x 20,3 x 1,27 cm

AKKU

10.400 mAh Lithium-Ionen

5 V 4,1 A Ausgang

5 V 2 A Eingang

3 USB-Ladeausgänge (1 x 2,1 A / 2 x 1 A)

Abmessungen: 11,75 x 7,94 x 2,10 cm

Gewicht: 0,31 kg

WARNUNG:

Nicht auseinandernehmen!

Nicht in Wasser eintauchen!

Nicht neben eine
Wärmequelle von mehr als
49°C platzieren!

Nicht kurzschließen!

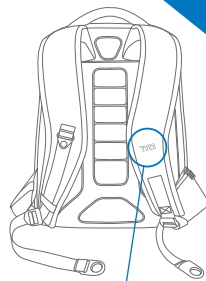

NFC befindet sich
im Schultergurt

NFC-KOMPATIBEL

1

PRT

MOCHILA ENERGI+

- 1 Bolsa de acessórios
- 2 Compartimento principal
- 3 Protect Pocket™
- 4 Compartimento para tablet
- 5 Compartimento para o computador portátil/bateria
- 6 Passagem para auscultadores
- 7 Passagem para carregamento
- 8 Bolso do cabo de recarregamento da bateria
- 9 Bolso para garrafa
- 10 Passagem para trolley
- 11 TYLT TAGZ™ NFC integrado 
- 12 Bolso para auscultadores
- 13 Passagem para carregamento

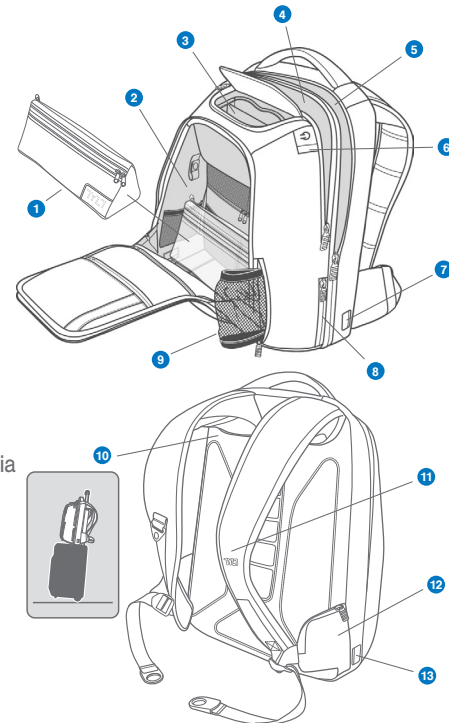

2 INÍCIO RÁPIDO

Digitalize este código para obter a informação mais atualizada sobre o produto.
www.TYLT.com

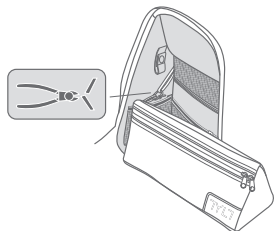

1. Corte os laços de segurança da bolsa de acessórios e retire a bateria e os cabos.

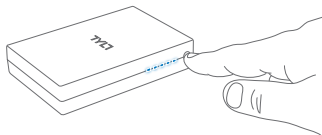

2. Prima e solte o botão de ligar/desligar a bateria.

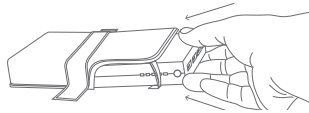

3. Coloque a bateria na bolsa de carregamento.

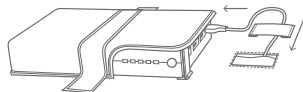

4. Ligue o cabo micro USB para carregamento à bateria. Insira o restante cabo no bolso do cabo de recarregamento da bateria.

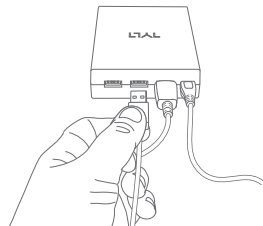

5. Ligue os cabos de carregamento do dispositivo à bateria. Utilize os cabos fornecidos ou qualquer outro cabo USB.

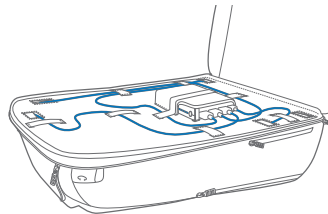

6. Passe os cabos e ligue aos dispositivos.

3 CARREGAR OS SEUS DISPOSITIVOS

Selecione o cabo compatível com o seu dispositivo. O conjunto de bateria TYLT® ENERGI funciona com os cabos fornecidos ou com qualquer outro cabo USB que tenha à mão.

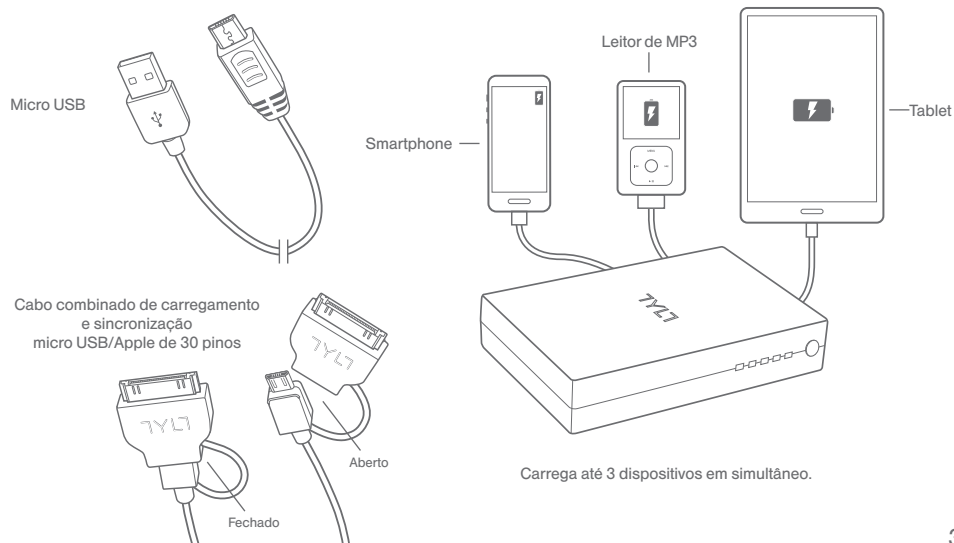

FUNCIONAMENTO DA BATERIA

>>LIGAR E DESLIGAR

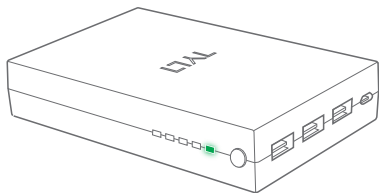

Ligar (ON)

Pressione uma vez o botão de ligar/desligar para ligar. As luzes azuis indicadoras da capacidade da bateria indicam o estado e a luz verde indica que a bateria está ligada (ON).

Desligar (OFF)

Mantenha o botão de ligar/desligar premido durante 3 segundos. As luzes azuis indicadoras piscam 3 vezes, a seguir desligam-se indicando que a bateria está desligada (OFF). Para preservar a vida útil da bateria, a ENERGY desliga-se automaticamente após 10 minutos sem carregamento do dispositivo.

>>VERIFICAR A CAPACIDADE DA BATERIA

Prima e solte rapidamente o botão de ligar/desligar.

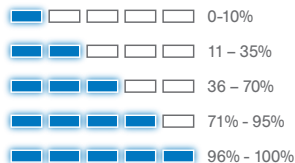
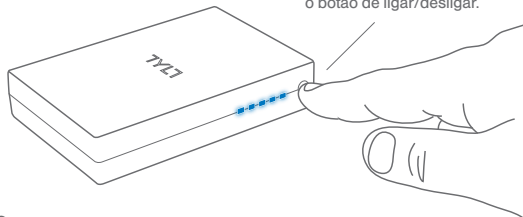

As luzes indicadoras do estado da bateria mostram a carga restante.

>>RECARREGAR A BATERIA ENERGI

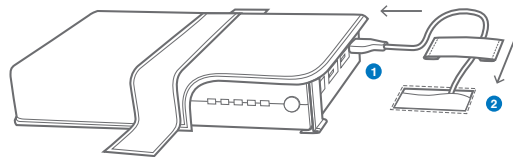

- 1 Ligue o cabo de carregamento micro USB à bateria ENERGY.
- 2 Passe a outra extremidade do cabo até ao bolso do cabo de recarregamento da bateria. Ligue a qualquer porta USB disponível para carregar.

Durante o carregamento, as luzes LED da capacidade indicam o estado da carga. **UM ÚNICO LED VERDE INDICA QUE O CARREGAMENTO ESTÁ CONCLUÍDO.**

A bateria ENERGY recarrega totalmente a partir do estado de vazio em 7-8 horas usando uma fonte de carregamento USB de 2 Amp.

Durante o recarregamento da bateria ENERGY, os dispositivos começam a carregar quando a bateria ENERGY atinge 50% da carga.



*Não incluído

ZONAS DE CARREGAMENTO

>>PASSAR OS SEUS CABOS

As aberturas de passagem permitem o acesso dos cabos a diferentes zonas de carregamento

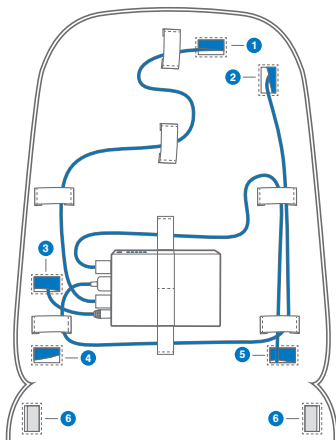

- 1 Compartimento para tablet
- 2 Protect Pocket™
- 3 Bolso do cabo de carregamento
- 4 Compartimento principal
- 5 Compartimento principal
- 6 Fora da mochila



Compartimento para tablet/iPad



Protect Pocket™



Compartimento principal grande e bolso de carregamento lateral



Carregamento exterior do dispositivo

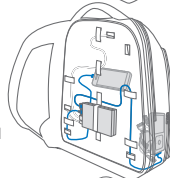
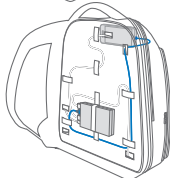
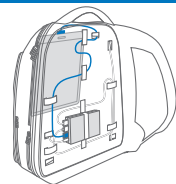

NFC

O ENERGI+ está equipado com uma etiqueta NFC programável TYLT TAGZ™ que consegue interagir com o seu dispositivo compatível com NFC. Um simples toque permite personalizar configurações e iniciar apps.

FÁCIL DE USAR

- 1) Verifique se o seu dispositivo é compatível com NFC e se o NFC está ligado nas configurações do dispositivo. Em caso afirmativo, toque no seu dispositivo no logótipo TYLT na alça da mochila para instalar a app gratuita para o NFC Task Launcher ou procure o NFC Task Launcher na Play Store.
- 2) Inicie a app para o NFC Task Launcher.
- 3) Siga as instruções no ecrã para configurar o seu TAGZ NFC.



Para instruções detalhadas, visite:
<http://launcher.tagstand.com>

COMPATÍVEL COM NFC

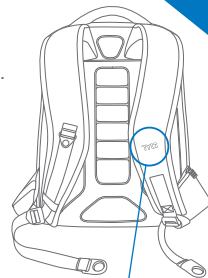

NFC localizado na alça do ombro

ESPECIFICAÇÕES

MOCHILA

Dimensões 29,21 x 34,29 x 48,26 cm

Peso: 1,72 kg

Adequada para computadores portáteis até 39,37 x 26,67 x 3,81 cm

Adequada para tablets até 26,67 x 20,32 x 1,27 cm

BATERIA

lões de lítio de 10.400mAh

Saída de 5V 4,1A

Entrada de 5V 2A

3 saídas de carregamento USB (1x2,1A/2x1A)

Dimensões 11,75 x 7,94 x 2,10 cm

Peso: 0,31 kg.

AVISO:

Não desmontar.

Não imergir em água.

Não guardar junto a uma fonte de calor superior a (49 °C).

Não provocar curto-circuito.

FCC Statement: This device complies with Part 15 of the FCC Rules. Operation is subject to the following two conditions: (1) this device may not cause harmful interference, and (2) this device must accept any interference received, including interference that may cause undesired operation.

ENG ©2013 TYLT. TYLT and the logo are trademarks of the Foreign Trade Corp. The N Mark is a trademark or registered trademark of NFC Forum, Inc. in the United States and in other countries. Other marks are the property of their respective owners.

Designed in the U.S.A. Made in China.

FRA ©2013 TYLT. TYLT et son logo sont des marques déposées de Foreign Trade Corp. La marque N est une marque commerciale ou déposée de NFC Forum, Inc. aux Etats-Unis et dans d'autres pays. Les autres marques sont la propriété de leurs détenteurs respectifs.

Conçu aux Etats-Unis. Fabriqué en Chine.

ESP ©2013 TYLT. TYLT y el logotipo son marcas registradas de Foreign Trade Corp. La marca N es una marca registrada de NFC Forum, Inc. en los Estados Unidos y en otros países. Otras marcas son propiedad de sus respectivos propietarios.

Diseñado en EE UU. Fabricado en China.

ITA ©2013 TYLT. TYLT e il logo sono marchi registrati della Foreign Trade Corp. N Mark è un marchio commerciale o un marchio registrato negli Stati Uniti e in altre nazioni dalla NFC Forum, Inc. Gli altri marchi sono di proprietà dei rispettivi titolari.

Progettato negli USA. Prodotto in Cina.

DEU ©2013 TYLT. TYLT und das Logo sind Marken der Foreign Trade Corp. Die Marke N ist eine Marke bzw. eine in den USA und anderen Ländern eingetragene Marke von NFC Forum, Inc. Weitere Marken sind Eigentum der jeweiligen Inhaber.

Konstruiert in den USA. Hergestellt in China.

PRT ©2013 TYLT. TYLT e o respetivo logótipo são marcas comerciais da Foreign Trade Corp. A marca N é uma marca comercial ou registada da NFC Forum, Inc. nos Estados Unidos e noutros países. As outras marcas são propriedade dos respetivos proprietários.

Concebido nos EUA. Produzido na China.



IC2000B