

● Instruction Manual for 8mm F3.5 FISH-EYE CS

Thank you for purchasing our 8mmF3.5 FISH-EYE CS lens. We believe that unique photography is possible when using our lens.

Our Complex new hybrid aspherical lens manufacturing technology, coupled with state-of-the-art optical technology, led to a lens that was patented, designed and manufactured for photographic purposes. Samyang was able to maintain the quality of the lens thoroughly and to reduce aberrations.

Advantages of the 8mm F3.5 FISH-EYE CS:

1. Conforms to APS-C (1:1.5x) size digital imaging
2. First fish-eye lens for actualizing 8mm focal length and a diagonal angle of view of 180 degrees for APS-C size.
3. Corrects aberrations using a complex aspherical lens and, at a fully opened position, produces a high resolution and a high contrast at the center of the lens as well as around the periphery of the lens.
4. Petal type hood and multi-coating by controlling flaring and ghosting.
5. Robust durability by incorporating a high stiffness aluminum base frame.

The 8mm F3.5 FISH-EYE CS lens for photography is designed with its own mount.

Users can photograph easily without installing an additional adaptor, by mounting the lens directly onto the camera.

Read this instruction manual carefully and use it properly.

※ Please read the safety precautions at the back of this instruction manual prior to use.

● Read this instruction manual prior to use. ●

1. Name of Each Component

[Fig.]

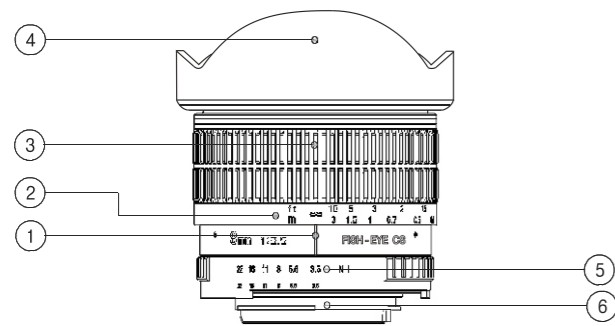

- ① Depth of field scale ② Focus scaling ring ③ Focusing ring
④ Hood locking area ⑤ Aperture adjustment ring ⑥ Lens ring mount (camera locking area)

2. Attaching and Detaching Camera

8mm F3.5 FISH-EYE CS IF lens mount is uniquely designed for Nikon (Fujifilm), Pentax (Samsung), Sony (Minolta) and Canon cameras respectively.

【Attaching】

Hold the hood locking area of the lens gently, align the lens mounting reference point or line with the lens ring mount of the camera, push the lens into the camera and turn the lens softly until it makes a clicking sound, and the depth of field scale is positioned on the upper part of the camera.

【Detaching】

Hold the hood locking area of the lens gently, press the lens release button on the camera, turn the lens in the opposite direction as attaching, and pull it out.

3. Focus Adjustment

The user can set the focus of a subject by turning the focus adjustment ring when using the 8mm F3.5 FISH-EYE CS lens, as it is an MF (Manual Focus) adjustment lens.

【Nikon (Fujifilm) / Pentax (Samsung) Mount】

- ① When focusing on a subject from a long distance, turn the focus ring to the left (∞ to 0.3) and focus on the clearest subject by using the indication signal on the camera or by checking visually.
- ② When focusing on a subject from a short distance, turn the focus ring to the right (0.3 to ∞) and focus on the clearest subject by using the indication signal on the camera or by checking visually.

【Sony (Minolta) / Canon Mount】

- ① When focusing on a subject from a long distance, turn the focus ring to the right (∞ to 0.3) and focus on the clearest subject by using the indication signal on the camera or by checking visually.
- ② When focusing on a subject from a short distance, turn the focus ring to the left (0.3 to ∞) and focus on the clearest subject by using the indication signal on the camera or by checking visually.

4. Brightness Control

The user can set the brightness he/she wants by turning the aperture adjustment ring when using the 8mm F3.5 FISH-EYE CS lens.

【Aperture adjustment ring indication】

① Nikon (Fujifilm) / Canon

22 16 11 8 5.6 3.5

② Pentax (Samsung)

A • 22 16 11 8 5.6 3.5

③ Sony (Minolta)

3.5 5.6 8 11 16 22

The brightness from 5.6 to 22 is set as 1 stop each, (1.5 stops between 3.5 and 5.6)
Brightness can be set more precisely by using the stop setting in between.

ex)

5.6 and 8 are set as 1 stop apart (1EV).

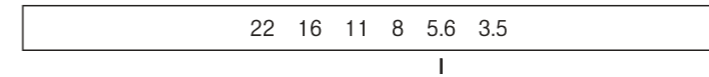

Set a 0.5 stop (0.5EV) between 5.6 and 8.

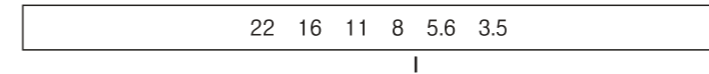

○ Pentax (Samsung)

1. Av Mode (Aperture Priority Mode)

The 8mm F3.5 FISH-EYE CS Pentax / Samsung mounts support Av mode (prioritizes aperture support)

- 1) Align the A mode indicator to the depth of field scale by pressing the A button installed on the aperture adjustment ring of the lens.

- 2) Set the mode dial of the camera to 'Av'.

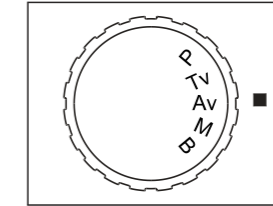

- 3) Set the focus adjustment lever of the camera to 'MF'.

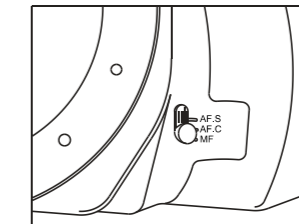

- 4) Set the menu on the camera.

The user sets the menu. → The aperture ring is used. → Not allowed.

5. Camera Settings

Some cameras require special settings when using this lens. Please refer to the following and set the camera when necessary.

○ Nikon (Fujifilm)

1. Set the camera mode dial to 'M'.

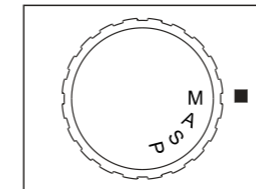

2. Set the focus adjustment lever of the camera to 'M'.

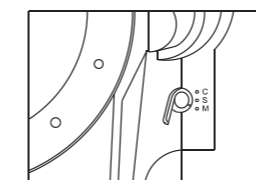

3. Some Nikon digital cameras are able to set the focal length and the brightness when attaching an MF lens. The MF lens can be used more efficiently if the focal length and the brightness are set on some Nikon digital cameras.

※ The shutter speed of some Nikon cameras changes automatically if the focal length and the brightness are set, and the desired brightness is set in A/S/P mode by turning the aperture adjustment ring.

(Settings for the camera or the menu may be changed depending on the model or due to a menu upgrade. Therefore refer to the camera manual or contact the camera manufacturer for detailed information.)

- 5) Adjust the brightness by turning the dial at the back of the camera.

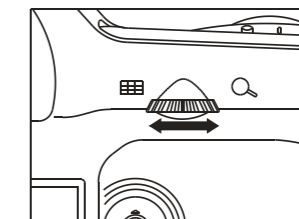

(The above procedure applies to the K20D. Settings for the camera or the menu may be changed depending on the model or due to a menu upgrade. Therefore refer to the camera manual or contact the camera manufacturer for detailed information.)

○ Sony (Minolta)

The aperture of the 8mm F3.5 FISH-EYE CS Sony (Minolta) mount is not geared to the camera.

If the F stop is set to above 8, the user may not be able to set the correct focus due to a difficulty in viewing a subject through the camera viewfinder.

Therefore turn the aperture adjustment ring and fully open it when attaching this lens to the camera, and then turn the aperture adjustment ring again to set the depth of focus and brightness you want to express prior to shooting.

- 1) Set the camera mode dial to 'M'.

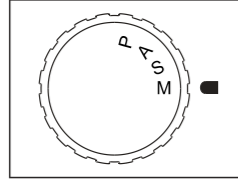

- 2) Set the focus adjustment lever of the camera to 'MF'.

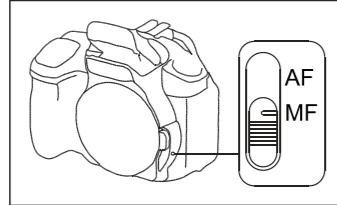

- 3) Adjust the shutter speed to achieve the appropriate exposure according to brightness.

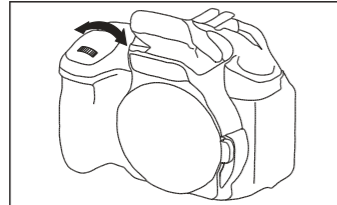

(The above procedure applies to the α350. Settings for the camera or the menu may be changed depending on the model or due to a menu upgrade. Therefore refer to the camera manual or contact the camera manufacturer for detailed information.)

○ Canon

The aperture of the 8mm F3.5 FISH-EYE CS Canon mount is not geared to the camera.

If the F stop is set to above 8, the user may not be able to set the correct focus due to a difficulty in viewing a subject through the camera viewfinder.

Therefore turn the aperture adjustment ring and fully open it when attaching this lens to the camera, and then turn the aperture adjustment ring again to set the depth of focus and brightness you want to express prior to shooting.

- 1) Set the camera mode dial to 'M'.

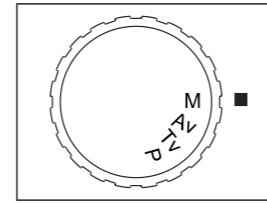

- 2) Adjust the shutter speed to achieve the appropriate exposure according to brightness.

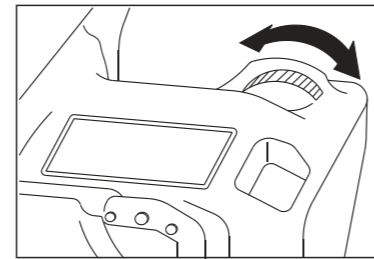

7. Specifications

Focal length	8 mm	
Max. aperture	F3.5	
Negative size	APS-C	
Angular field	APS-C (1:1.5x)	180° (diagonal)
	APS-C (1:1.6x)	167° (diagonal)
Focusing range	∞ to 0.3 m	
Filter connection	N/A	
Number of elements	10 elements	
Number of groups	8 groups	
Size (without hood)	Nikon Mount	74.8 mm X ø 75 mm
	Pentax Mount	75.8 mm X ø 75 mm
	Sony Mount	76.8 mm X ø 75 mm
	Canon Mount	77.3 mm X ø 75 mm
Weight (without hood)	Nikon Mount	417 g
	Pentax Mount	414 g
	Sony Mount	424 g
	Canon Mount	443 g

9. Instructions Prior To Use

The following precautions are divided into two types according to the level of danger.

⚠ WARNING
If this instruction is not followed, it may cause death or severe injury to the user.

⚠ CAUTION
If this instruction is not followed, it may cause death or severe injury to the user.

The following pictograms are used in the below precautions:

⚠ Requires caution. Inside the pictogram it shows contents of precautions. (It shows outbreak of fire in the pictogram on the left.)
⚡ Shows prohibition. Inside the pictogram it shows contents of prohibition. (It shows prohibition of dismantling in the pictogram on the left.)
👤 Shows instruction. Inside the pictogram it shows contents of instructions. (It shows instruction of precaution in the pictogram on the left.)

⚠ WARNING

👁️ Don't look at the sun through the lens. It may cause blindness.



👶 Don't leave the lens within reach of babies, as it may cause injury to the baby if the lens falls or is dropped.



⚠ CAUTION

🔩 Attach the lens to the camera correctly and ensure the lens is held in place properly; otherwise the lens may not be removable, or may become loose and cause an accident.

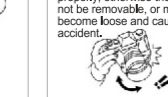

🔥 Don't attempt to modify or alter the lens. It may lead to failure of the camera. Modified or altered lenses may not be repaired.



👉 Don't put excessive pressure on the lens attached to the camera; otherwise it may cause damage to the lens or to the camera mount. Be sure to hold the lens when operating or moving.

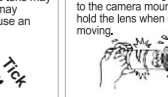

🔥 Don't leave the lens in direct sunlight. It may cause a fire, depending on lenses that concentrate light on a close object.



👤 Ensure that the camera operates properly by checking the lens beforehand or by test shooting for important events such as a wedding ceremony and an overseas trip.



👁️ Don't look at the sun directly through a camera with a lens attached. It may cause damage to one's eyesight.



⚠ WARNING!

Don't wet this product or expose it to a moist environment. It may cause a fire or electric shock.

⚠ CAUTION!

- Don't use this product or store it close to devices that generate heat i.e., heaters, thermal regulators, stoves, stereo amplifiers.
- Don't leave the lens in conditions where drastic temperature changes can occur.
- Don't touch the surface of the lens by hand, and avoid making contact with sharp objects.
- Avoid dropping the lens.
- Don't soak the lens in water, and avoid water splashing onto the lens.
- If there are foreign bodies on the lens, use a lens cleaning kit only.
- If the lens hood is cut by the user, it may cause damage to the surface of the lens, as the surface of the lens may make contact with the floor.

○ Konica Minolta (Minolta) DYNA Series

If this lens is used on some Konica Minolta (Minolta) DYNA series cameras, the release lock of the camera for prohibiting misuse must be disengaged. It is required to disengage the release lock only in case of the first use as below.

Disengagement setting procedure for the release lock function:

- ① Turn off the camera.
- ② Detach the lens from the camera body and set the main switch of the camera to ON by pressing the two following buttons.

9xi···function button + AE lock button 303si···AV button + self mode button
7xi···function button + AE lock button 303si SUPER···drive button + spot button
5xi···function button + spot button 101si···self-timer button + flash button
3xi···Modification is required at a service center. 360si···self-timer continuous shooting button + scene select button

807si···AEL button + shooting scene select button α-Sweet···self-timer continuous shooting button + spot button
707si···card button + spot button α-Sweet S···(Set the function dial to the multiple exposure.)
507si···lens replacement button + ISO lock button P button + self-timer button
DYNAX3L···shooting scene selection button + button DYNAX30···self-timer button + Turn the left dial on the camera body to off.

α-Sweet II , II L··· Set the camera to the custom function 14 and change the selection number 1 to 2 (N.A).

α-7, -9, -Tj··· Set the camera to the custom function 16 and change the selection number 1 to 2 (N.A).

α-Sweet Digital···Execute the following operation.

MENU ⇒ *2 ⇒ release lock without a lens ⇒ to the right ⇒ N.A ⇒ ●execute ⇒ MENU

α-7 Digital... Execute the following operation.

MENU ⇒ *3 ⇒ release lock without a lens ⇒ to the right ⇒ N.A ⇒ ●execute ⇒ MENU

※ If the release lock is disengaged in the above way, the state of disengagement is maintained even though the main switch is turned off. Execute the above procedure again if you want to use the release lock function.

(Settings for the camera or the menu may be changed depending on the model or due to a menu upgrade. Therefore refer to the camera manual or contact the camera manufacturer for detailed information.)

※ The shutter speed of some Canon cameras changes automatically if the shooting mode dial is set to Av and the brightness is set by turning the aperture adjustment ring. Therefore the shutter speed is not required to be set additionally as with the M mode.

(The above procedure applies to the 40D. Settings for the camera or the menu may be changed depending on the model or due to a menu upgrade. Therefore refer to the camera manual or contact the camera manufacturer for detailed information.)

6. About Photography

The 8mm F3.5 FISH-EYE CS lens has a diagonal angle of view of 180 degrees and therefore one can take fun pictures when using it with one's subjective expressions.

It's short focal length and 180 degrees angle of view enables one to take pictures fitting into full images and is useful for capturing landscapes.

8. Fault Finding

Phenomena	Causes	Measures
A lens can't be attached to the camera.	The lens ring mount and the camera mount are not aligned.	Align the lens ring mount and the camera mount.
A lens can't be detached from the camera.	Incorrect rotation direction for detaching. If the user turns the lens while holding the camera, it may cause damage to the lens.	Press the lens release button on the camera, and lightly turn the lens to the lens attaching and detaching reference points, in the direction as marked on the camera, and then pull the lens forward.
Dark image	Incorrect focusing. Insufficient shutter speed or camera shake.	Turn the focus ring while checking the indication or checking an object visually, set the focus until it reaches a clear point, and then press the shutter. Steady the camera and take a photograph at a shutter speed of 1/125 secs.
Autofocus failure	Autofocus failed with a manual control focus lens.	Set focus by turning the focus ring.
Dark or too bright pictures	Inappropriate exposure	Adjust the aperture size.
The periphery gets dark when using a manual camera or a digital camera for 1:1 image sensor.	As this lens is optimized for APS-C size images, so the periphery gets dark when using a digital camera for 1:1 size images.	Use a digital camera for APS-C size images.
The camera flash is not geared to the camera.	The manual control lens may not be compatible, depending on the camera.	See the camera manual.
The camera finder indication or the display is not displayed.	This lens doesn't have an electric contact signal, so there is no communication with the camera through electric signals.	No problem with shooting.
Zooming failure	This lens is a single lens.	
The lens hood can't be detached.	This lens hood and the lens body are a fixed type, so the lens hood can't be detached.	
This lens can't be mounted on other cameras.	This lens is designed for its own mount.	Purchase the required lens mount.
The user wants to attach Samyang's 2X or 1.4X convertor lens.	Samyang's convertor is designed with a T (M42 screw) mount only, therefore only an 8mm F3.5 FISH-EYE CS lens can be used.	Use each company's own mount convertor. But autofocus is not available.