

# Unpacking

Thank you for buying the MSI® **Z370I GAMING PRO CARBON AC** motherboard. Check to make sure your motherboard box contains the following items. If something is missing, contact your dealer as soon as possible.

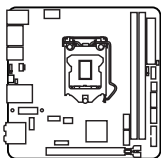

Motherboard

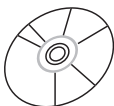

Drivers & Utilities  
Disc



Motherboard User  
Guide

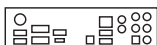

I/O Shield

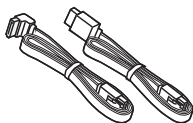

SATA Cable x2



RGB LED Extension  
Cable 80cm x1



SATA Cable Labels

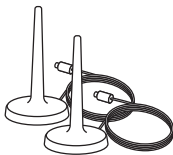

Antenna x2



CORSAIR HD RGB LED  
Cable 50cm x1\*

\* Only for connecting the Corsair HD Series, HD120 RGB LED Case Fan.

# Safety Information

- The components included in this package are prone to damage from electrostatic discharge (ESD). Please adhere to the following instructions to ensure successful computer assembly.
- Ensure that all components are securely connected. Loose connections may cause the computer to not recognize a component or fail to start.
- Hold the motherboard by the edges to avoid touching sensitive components.
- It is recommended to wear an electrostatic discharge (ESD) wrist strap when handling the motherboard to prevent electrostatic damage. If an ESD wrist strap is not available, discharge yourself of static electricity by touching another metal object before handling the motherboard.
- Store the motherboard in an electrostatic shielding container or on an anti-static pad whenever the motherboard is not installed.
- Before turning on the computer, ensure that there are no loose screws or metal components on the motherboard or anywhere within the computer case.
- Do not boot the computer before installation is completed. This could cause permanent damage to the components as well as injury to the user.
- If you need help during any installation step, please consult a certified computer technician.
- Always turn off the power supply and unplug the power cord from the power outlet before installing or removing any computer component.
- Keep this user guide for future reference.
- Keep this motherboard away from humidity.
- Make sure that your electrical outlet provides the same voltage as is indicated on the PSU, before connecting the PSU to the electrical outlet.
- Place the power cord such a way that people can not step on it. Do not place anything over the power cord.
- All cautions and warnings on the motherboard should be noted.
- If any of the following situations arises, get the motherboard checked by service personnel:
  - Liquid has penetrated into the computer.
  - The motherboard has been exposed to moisture.
  - The motherboard does not work well or you can not get it work according to user guide.
  - The motherboard has been dropped and damaged.
  - The motherboard has obvious sign of breakage.
- Do not leave this motherboard in an environment above 60°C (140°F), it may damage the motherboard.

# Quick Start

## Preparing Tools and Components

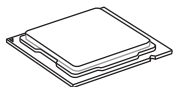

Intel® LGA 1151 CPU

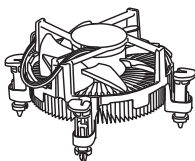

CPU Fan

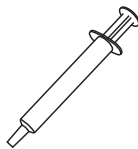

Thermal Paste

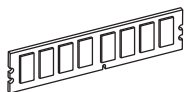

DDR4 Memory

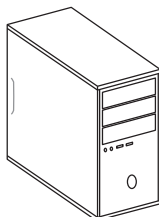

Chassis

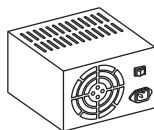

Power Supply Unit



SATA DVD Drive



SATA Hard Disk Drive

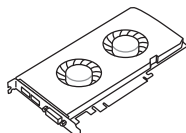

Graphics Card

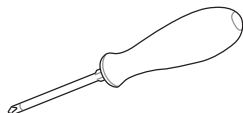

Phillips Screwdriver



A Package of Screws

## Installing a Processor



<https://youtu.be/4ce91YC30ww>

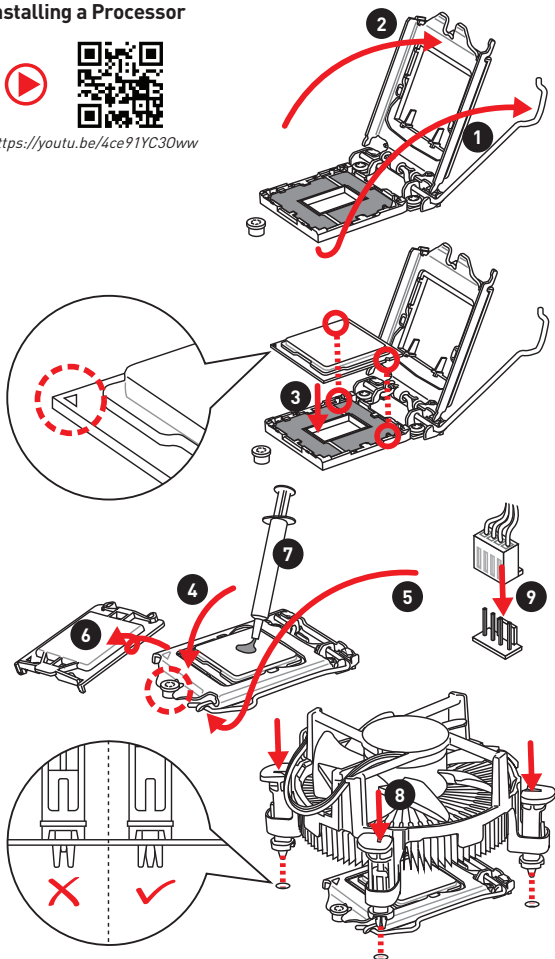

## Installing DDR4 memory



<http://youtu.be/T03aDrJPYQs>

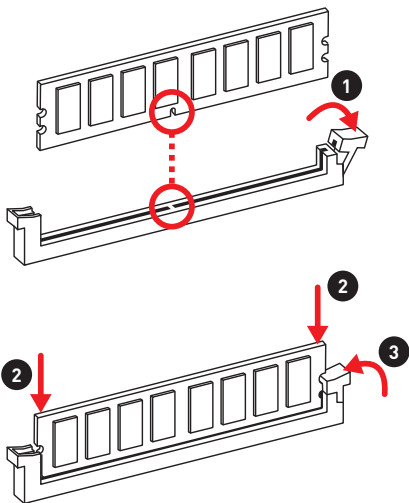

## Connecting the Front Panel Header



<http://youtu.be/DPELIdVNZUI>

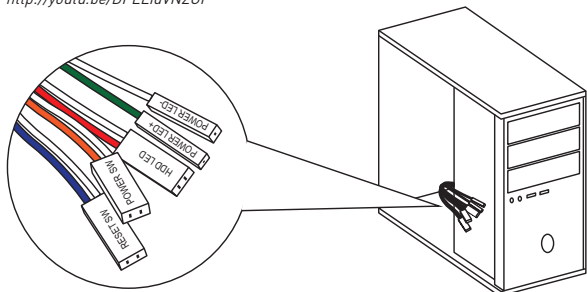

2	10	1	HDD LED +	2	Power LED +
3		3	HDD LED -	4	Power LED -
1	9	5	Reset Switch	6	Power Switch
JFP1		7	Reset Switch	8	Power Switch
		9	Reserved	10	No Pin

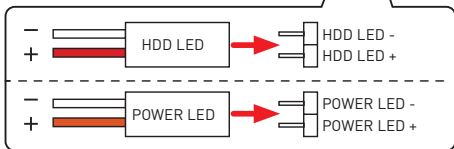
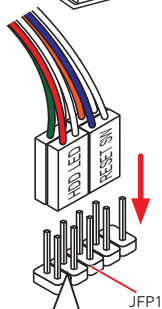

## Installing the Motherboard

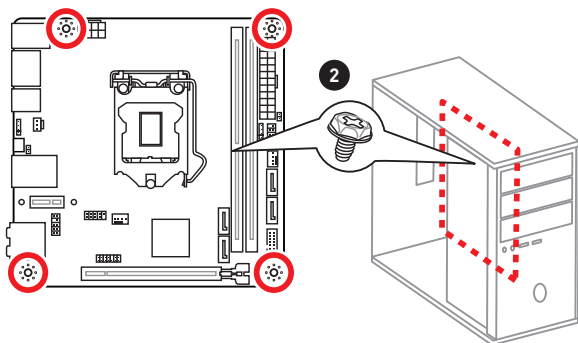
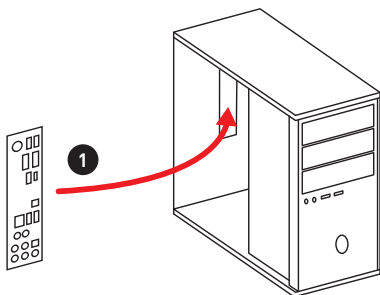

## Installing SATA Drives



<http://youtu.be/RZsMpqxythc>

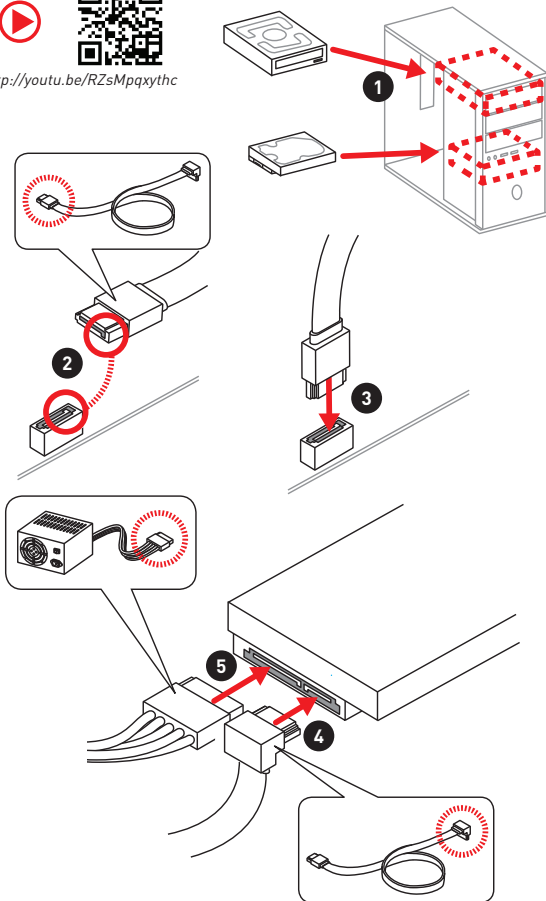

## Installing a Graphics Card



[http://youtu.be/mG0GZpr9w\\_A](http://youtu.be/mG0GZpr9w_A)

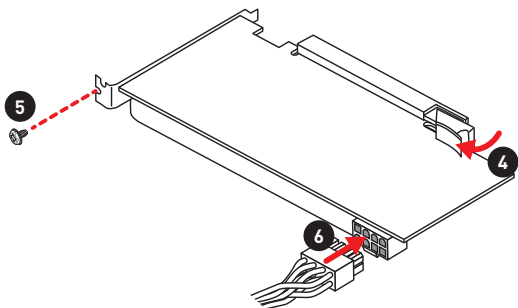
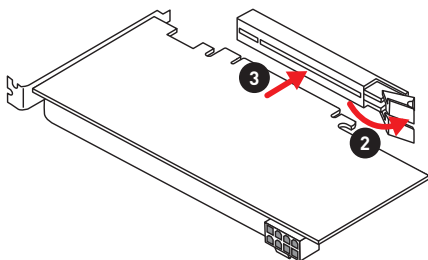
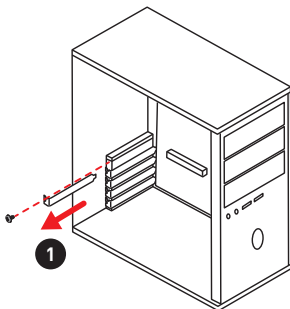

## Connecting Peripheral Devices

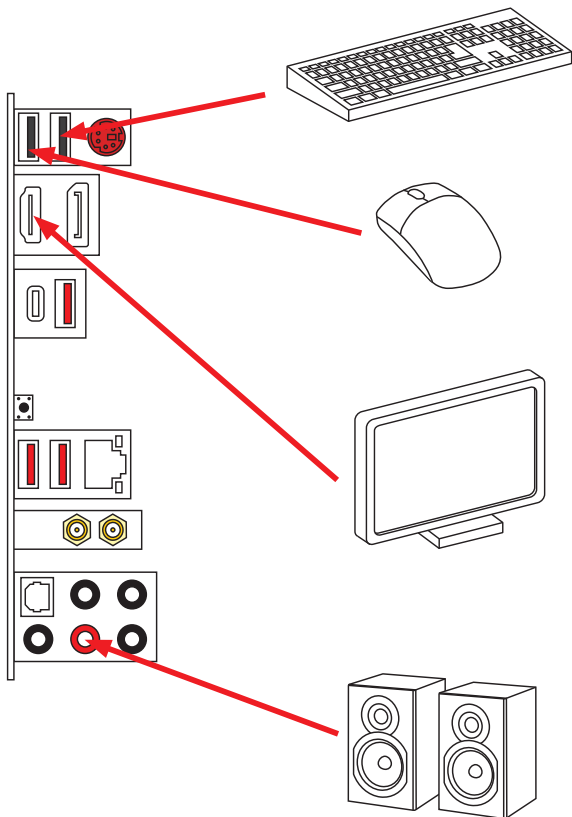

## Connecting the Power Connectors



[http://youtu.be/gkDYyR\\_8314](http://youtu.be/gkDYyR_8314)

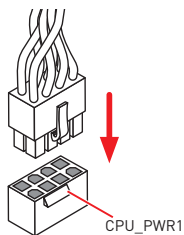
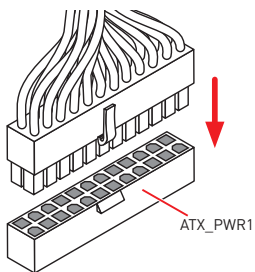
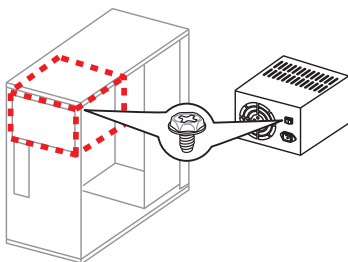

# Power On

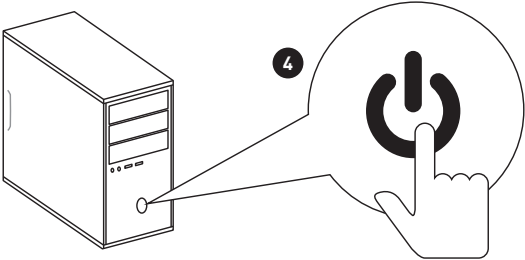
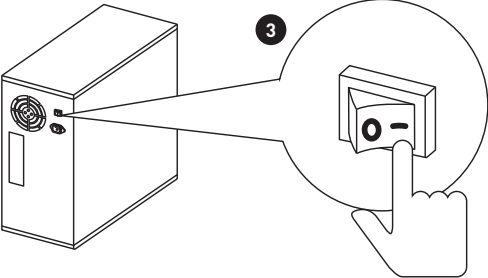
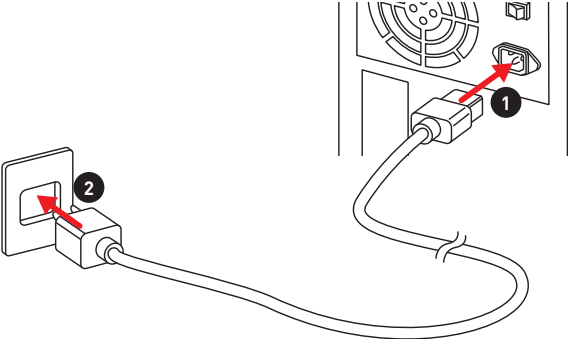

# Contents

<b>Unpacking</b> .....	<b>1</b>
<b>Safety Information</b> .....	<b>2</b>
<b>Quick Start</b> .....	<b>3</b>
Preparing Tools and Components .....	3
Installing a Processor .....	4
Installing DDR4 memory .....	5
Connecting the Front Panel Header .....	6
Installing the Motherboard .....	7
Installing SATA Drives .....	8
Installing a Graphics Card .....	9
Connecting Peripheral Devices .....	10
Connecting the Power Connectors .....	11
Power On .....	12
<b>Specifications</b> .....	<b>16</b>
<b>Block Diagram</b> .....	<b>21</b>
<b>Rear I/O Panel</b> .....	<b>22</b>
LAN Port LED Status Table .....	22
Audio Ports Configuration .....	22
Realtek HD Audio Manager .....	23
<b>Overview of Components</b> .....	<b>25</b>
M2_1: M.2 Slot (Key M) .....	27
CPU Socket .....	28
DIMM Slots .....	29
M2_2: M.2 Wi-Fi module slot (Key E) .....	29
PCI_E1: PCIe Expansion Slot .....	30
SATA1~4: SATA 6Gb/s Connectors .....	30
CPU_PWR1, ATX_PWR1: Power Connectors .....	31
JFP1, JFP2: Front Panel Connectors .....	31
JUSB1: USB 2.0 Connector .....	32
JUSB2: USB 3.1 Gen1 Connector .....	32
CPU_FAN1, SYS_FAN1: Fan Connectors .....	33
JAUD1: Front Audio Connector .....	34
JCI1: Chassis Intrusion Connector .....	34
JTPM1: TPM Module Connector .....	35
JBAT1: Clear CMOS (Reset BIOS) Jumper .....	35
JRGB1, JCORSAIR1: RGB LED Connectors .....	36

<b>Onboard LEDs</b> .....	<b>37</b>
EZ Debug LEDs .....	37
DIMM LEDs .....	37
PCIe x16 slot LEDs.....	37
<b>BIOS Setup</b> .....	<b>38</b>
Entering BIOS Setup.....	38
Resetting BIOS.....	39
Updating BIOS.....	39
EZ Mode .....	40
Advanced Mode .....	42
SETTINGS.....	43
Advanced.....	43
Boot.....	48
Security.....	49
Save & Exit .....	51
OC.....	52
M-FLASH .....	58
OC PROFILE .....	59
HARDWARE MONITOR.....	60
<b>Software Description</b> .....	<b>61</b>
Installing Windows® 10.....	61
Installing Drivers .....	61
Installing Utilities .....	61
APP MANAGER .....	62
LIVE UPDATE 6.....	63
COMMAND CENTER .....	65
GAMING APP.....	69
X-BOOST .....	74
MYSTICLIGHT.....	76
MSI SMART TOOL .....	78
RAMDISK.....	80
GAMING LAN MANAGER .....	81
DRAGON EYE .....	83
Nahimic 2.....	84
SteelSeries Engine 3 .....	88
Intel® Extreme Tuning Utility.....	90
CPU-Z.....	91
TriDef VR .....	92
TriDef SmartCam.....	95

<b>RAID Configuration</b> .....	<b>96</b>
Using Intel® Rapid Storage Technology Option ROM .....	96
Degraded RAID Array .....	99
<b>Intel® Optane™ Memory Configuration</b> .....	<b>101</b>
System Requirements .....	101
Installing the Intel® Optane™ memory .....	101
Removing the Intel® Optane™ memory .....	103
Troubleshooting .....	104
<b>Troubleshooting</b> .....	<b>105</b>
<b>Regulatory Notices</b> .....	<b>106</b>

# Specifications

<b>CPU</b>	Supports 8th Generation Intel® Core™ Processors, and Intel® Pentium® and Celeron® Processors for Socket LGA1151
<b>Chipset</b>	Intel® Z370 Express Chipset
<b>Memory</b>	<ul style="list-style-type: none"> <li>• 2x DDR4 memory slots, support up to 32GB</li> <li>• Supports 4500(OC)/ 4400(OC)/ 4333(OC)/ 4266(OC)/ 4133(OC)/ 4000(OC)/ 3866(OC)/ 3733(OC)/ 3600(OC)/ 3466(OC)/ 3400(OC)/ 3333(OC)/ 3300(OC)/ 3200(OC)/ 3000(OC)/ 2800(OC)/ 2667/ 2400/ 2133 MHz Memory*</li> <li>• Supports Dual-Channel mode</li> <li>• Supports non-ECC, un-buffered memory</li> <li>• Supports Intel® Extreme Memory Profile (XMP)</li> </ul> <p>* Please refer <a href="http://www.msi.com">www.msi.com</a> for more information on compatible memory.</p>
<b>Expansion Slots</b>	<ul style="list-style-type: none"> <li>• 1x PCIe 3.0 x16 slot</li> </ul>
<b>Onboard Graphics</b>	<ul style="list-style-type: none"> <li>• 1x HDMI™ port, supports a maximum resolution of 4096x2160@30Hz, 2560x1600@60Hz</li> <li>• 1x DisplayPort port, supports a maximum resolution of 4096x2304@24Hz, 3840x2160@60Hz, 1920x1200@60Hz</li> </ul>
<b>Storage</b>	<p>Intel® Z370 Chipset</p> <ul style="list-style-type: none"> <li>• 4x SATA 6Gb/s ports           <ul style="list-style-type: none"> <li>▪ Supports RAID 0, RAID1, RAID 5 and RAID 10 for SATA storage devices</li> </ul> </li> <li>• 1x M.2 slot [M2_1, Key M]           <ul style="list-style-type: none"> <li>▪ Support up to PCIe 3.0 x4 and SATA 6Gb/s</li> <li>▪ Supports 2242/ 2260 /2280 storage devices</li> <li>▪ Intel® Optane™ Memory Ready</li> </ul> </li> </ul>
<b>Audio</b>	<ul style="list-style-type: none"> <li>• Realtek® ALC1220 Codec</li> <li>• 7.1-Channel High Definition Audio</li> <li>• Supports S/PDIF output</li> </ul>
<b>LAN</b>	1x Intel I219-V Gigabit LAN controller

Continued on next page

Continued from previous page

<b>Wireless LAN &amp; Bluetooth®</b>	<p>Intel® Dual Band Wireless-AC 8265 module</p> <ul style="list-style-type: none"><li>• The Wireless module is pre-install in the M2_2 (M.2 Key E) slot.</li><li>• Supports Wi-Fi 802.11 a/b/g/n/ac, dual band (2.4GHz, 5GHz) up to 867 Mbps speed.</li><li>• Supports Dual Mode Bluetooth® 2.1, 2.1+EDR, 3.0, 4.0, BLE, 4.2</li></ul>
<b>USB</b>	<ul style="list-style-type: none"><li>• ASMedia® ASM3142 Chipset<ul style="list-style-type: none"><li>▪ 1x USB 3.1 Gen2 (SuperSpeed USB 10Gbps) Type-C port on the back panel</li><li>▪ 1x USB 3.1 Gen2 (SuperSpeed USB 10Gbps) Type-A port on the back panel</li></ul></li><li>• Intel® Z370 Chipset<ul style="list-style-type: none"><li>▪ 4x USB 3.1 Gen1 (SuperSpeed USB) ports (2 Type-A ports on the back panel, 2 ports available through the internal USB connector)</li><li>▪ 4x USB 2.0 (High-speed USB) ports (2 Type-A ports on the back panel, 2 ports available through the internal USB connector)</li></ul></li></ul>
<b>Back Panel Connectors</b>	<ul style="list-style-type: none"><li>• 1x PS/2 keyboard/ mouse combo port</li><li>• 2x USB 2.0 Type-A ports</li><li>• 1x DisplayPort port</li><li>• 1x HDMI™ port</li><li>• 1x USB 3.1 Gen2 Type-A port</li><li>• 1x USB 3.1 Gen2 Type-C port</li><li>• 1x Clear CMOS button</li><li>• 1x LAN (RJ45) port</li><li>• 2x USB 3.1 Gen1 Type-A ports</li><li>• 2x Wi-Fi Antenna connectors</li><li>• 5x OFC audio jacks</li><li>• 1x Optical S/PDIF OUT connector</li></ul>

Continued on next page

Continued from previous page

<b>Internal Connectors</b>	<ul style="list-style-type: none"><li>• 1x 24-pin ATX main power connector</li><li>• 1x 8-pin ATX 12V power connector</li><li>• 4x SATA 6Gb/s connectors</li><li>• 1x USB 3.1 Gen1 connector (supports additional 2 USB 3.1 Gen1 ports)</li><li>• 1x USB 2.0 connector (supports additional 2 USB 2.0 ports)</li><li>• 1x 4-pin CPU fan connector</li><li>• 1x 4-pin system fan connector</li><li>• 1x Front panel audio connector</li><li>• 2x Front panel connectors</li><li>• 1x TPM module connector</li><li>• 1x Chassis Intrusion connector</li><li>• 1x Clear CMOS jumper</li><li>• 1x 5050 RGB LED strip 12V connector</li><li>• 1x CORSAIR Individually Addressable RGB LED strip 5V connector</li></ul>
<b>I/O Controller</b>	NUVOTON NCT5565 Controller Chip
<b>Hardware Monitor</b>	<ul style="list-style-type: none"><li>• CPU/System temperature detection</li><li>• CPU/System fan speed detection</li><li>• CPU/System fan speed control</li></ul>
<b>Form Factor</b>	<ul style="list-style-type: none"><li>• Mini-ITX Form Factor</li><li>• 6.7 in. x 6.7 in. (17.0 cm x 17.0 cm)</li></ul>
<b>BIOS Features</b>	<ul style="list-style-type: none"><li>• 1x 128 Mb flash</li><li>• UEFI AMI BIOS</li><li>• ACPI 6.0 , SMBIOS 3.0</li><li>• Multi-language</li></ul>

Continued on next page

Continued from previous page

<b>Software</b>	<ul style="list-style-type: none"><li>• Drivers</li><li>• APP MANAGER</li><li>• SUPER CHARGER</li><li>• COMMAND CENTER</li><li>• LIVE UPDATE 6</li><li>• MSI SMART TOOL</li><li>• RAMDISK</li><li>• DPC LATENCY TUNER</li><li>• FAST BOOT</li><li>• X-BOOST</li><li>• DRAGON EYE</li><li>• GAMING APP</li><li>• MYSTIC LIGHT</li><li>• GAMING LAN MANAGER</li><li>• Nahimic Audio</li><li>• Open Broadcaster Software (OBS)</li><li>• TriDef® VR &amp; SmartCam</li><li>• SteelSeries Engine 3</li><li>• WTFast*</li><li>• CPU-Z MSI GAMING</li><li>• Intel® Extreme Tuning Utility</li><li>• Google Chrome™ ,Google Toolbar, Google Drive</li><li>• Norton™ Internet Security Solution</li></ul> <p>* This offer is valid for a limited period only, for more information please visit <a href="http://www.msi.com">www.msi.com</a></p>
<b>Special Features</b>	<ul style="list-style-type: none"><li>• Audio<ul style="list-style-type: none"><li>▪ Audio Boost 4</li><li>▪ Nahimic 2</li></ul></li><li>• Network<ul style="list-style-type: none"><li>▪ GAMING LAN with Gaming LAN Manager</li><li>▪ Intel Wi-Fi</li></ul></li></ul>

Continued on next page

Continued from previous page

## Special Features

- Storage
  - Turbo M.2
- Fan
  - Smart Fan Control
- LED
  - Mystic Light
  - Mystic Light Extension (RGB)
  - Corsair Extension
  - Mystic light SYNC
  - EZ DEBUG LED
- Protection
  - DDR4 Steel Armor
  - PCI-E Steel Armor
- Performance
  - DDR4 Boost
  - Lightning USB
  - USB with Type A+C
- Stability
  - Military Class 4
- VR
  - VR Ready
- Gamer Experience
  - GAMING HOTKEY
  - GAMING MOUSE Control
- BIOS
  - Click BIOS 5
- Certification
  - Quadro Ready
  - SteelSeries Certified

# Block Diagram

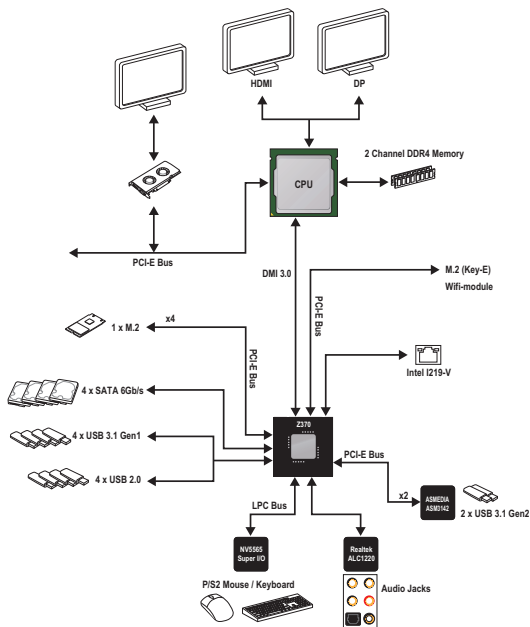

## Rear I/O Panel

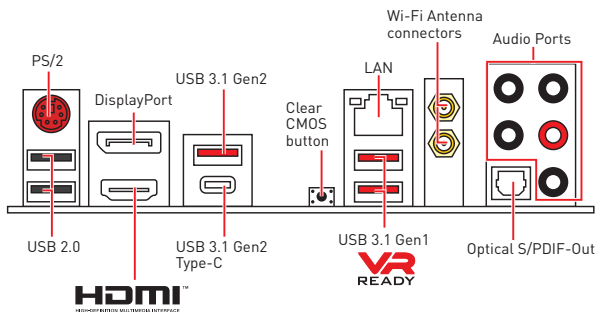

- **Clear CMOS button** - Power off your computer. Press and hold the Clear CMOS button for about 5-10 seconds to reset BIOS to default values.

## LAN Port LED Status Table

Link/ Activity LED			Speed LED	
Status	Description		Status	Description
Off	No link	Off	10 Mbps connection	
Yellow	Linked	Green	100 Mbps connection	
Blinking	Data activity	Orange	1 Gbps connection	

## Audio Ports Configuration

Audio Ports	Channel			
	2	4	6	8
Center/ Subwoofer Out			●	●
Rear Speaker Out		●	●	●
Line-In/ Side Speaker Out				●
Line-Out/ Front Speaker Out	●	●	●	●
Mic In				

(●: connected, Blank: empty)

## Realtek HD Audio Manager

After installing the **Realtek HD Audio** driver, the **Realtek HD Audio Manager** icon will appear in the system tray. Double click on the icon to launch.



- **Device Selection** - allows you to select a audio output source to change the related options. The **check** sign indicates the devices as default.
- **Application Enhancement** - the array of options will provide you a complete guidance of anticipated sound effect for both output and input device.
- **Main Volume** - controls the volume or balance the right/left side of the speakers that you plugged in front or rear panel by adjust the bar.
- **Profiles** - toggles between profiles.
- **Advanced Settings** - provides the mechanism to deal with 2 independent audio streams.
- **Jack Status** - depicts all render and capture devices currently connected with your computer.
- **Connector Settings** - configures the connection settings.

### Auto popup dialog

When you plug into a device at an audio jack, a dialogue window will pop up asking you which device is current connected.

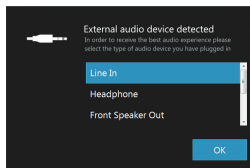

Each jack corresponds to its default setting as shown on the next page.

## Audio jacks to headphone and microphone diagram

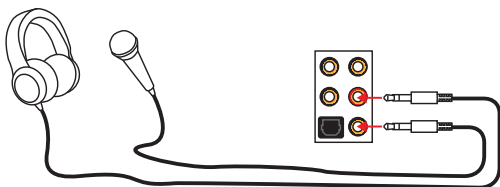

## Audio jacks to stereo speakers diagram

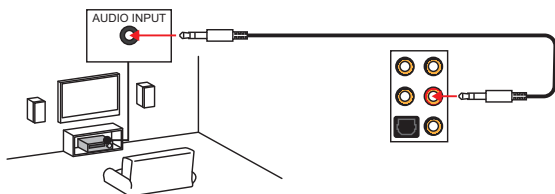

## Audio jacks to 7.1-channel speakers diagram

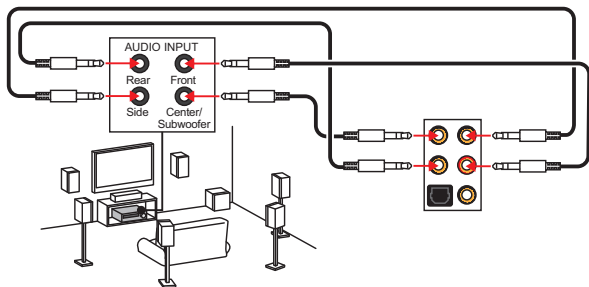

# Overview of Components

## Top View

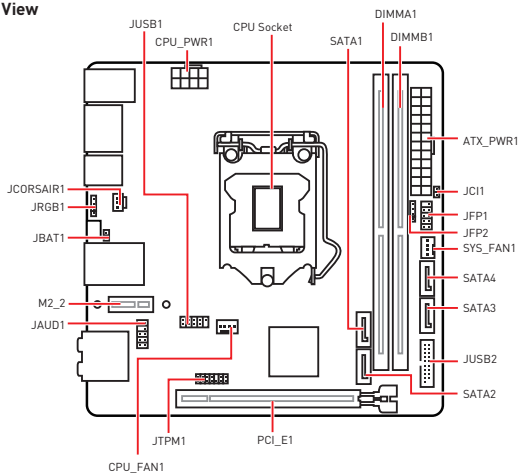

## Bottom View

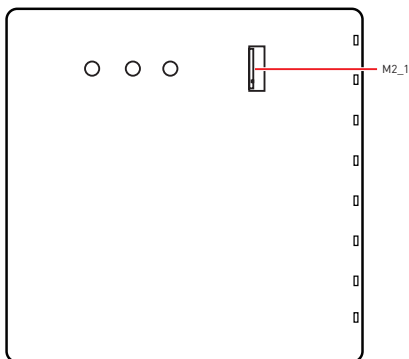

## Component Contents

Port Name	Port Type	Page
CPU_FAN1, SYS_FAN1	Fan Connectors	33
CPU_PWR1, ATX_PWR1	Power Connectors	31
CPU Socket	LGA1151 CPU Socket	28
DIMMA1, DIMMB1	DIMM Slots	29
JAUD1	Front Audio Connector	34
JBAT1	Clear CMOS (Reset BIOS) Jumper	35
JCI1	Chassis Intrusion Connector	34
JFP1, JFP2	Front Panel Connectors	31
JRGB1, JCORSAIR1	RGB LED Connectors	36
JTPM1	TPM Module Connector	35
JUSB1	USB 2.0 Connector	32
JUSB2	USB 3.1 Gen1 Connector	32
M2_1	M.2 Slot (Key M)	27
M2_2	M.2 Wi-Fi module slot (Key E)	29
PCI_E1	PCIe Expansion Slot	30
SATA1-4	SATA 6Gb/s Connectors	30

## M2\_1: M.2 Slot (Key M)

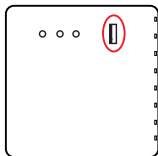

### **Important**

- Before you install the motherboard into the case, make sure your M.2 module has been installed properly.
- Intel® RST only supports PCIe M.2 SSD with UEFI ROM.
- Intel® Optane™ Memory Ready for all M.2 slot.



### **Video Demonstration**

Watch the video to learn how to use M.2 Shield.

<https://youtu.be/NwtQBpkUazs>

## Installing M.2 module

1. Remove the screw from the base screw.
2. Remove the base screw.

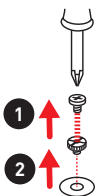

3. Tighten the base screw into the hole of the distance to the M.2 slot as the length your M.2 module.
4. Insert your M.2 module into the M.2 slot at a 30-degree angle.

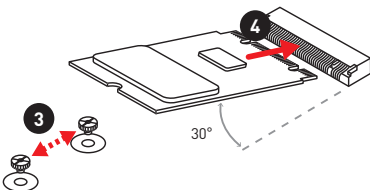

5. Put the screw in the notch on the trailing edge of your M.2 module and tighten it into the base screw.

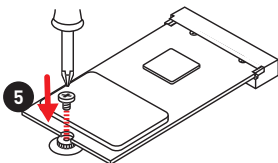

## CPU Socket

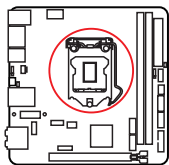

### Introduction to the LGA 1151 CPU

The surface of the LGA 1151 CPU has two **notches** and a **golden triangle** to assist in correctly lining up the CPU for motherboard placement. The golden triangle is the Pin 1 indicator.

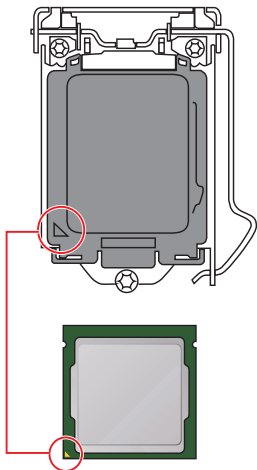

### Important

- Always unplug the power cord from the power outlet before installing or removing the CPU.
- Please retain the CPU protective cap after installing the processor. MSI will deal with Return Merchandise Authorization (RMA) requests if only the motherboard comes with the protective cap on the CPU socket.
- When installing a CPU, always remember to install a CPU heatsink. A CPU heatsink is necessary to prevent overheating and maintain system stability.
- Confirm that the CPU heatsink has formed a tight seal with the CPU before booting your system.
- Overheating can seriously damage the CPU and motherboard. Always make sure the cooling fans work properly to protect the CPU from overheating. Be sure to apply an even layer of thermal paste (or thermal tape) between the CPU and the heatsink to enhance heat dissipation.
- Whenever the CPU is not installed, always protect the CPU socket pins by covering the socket with the plastic cap.
- If you purchased a separate CPU and heatsink/ cooler, Please refer to the documentation in the heatsink/ cooler package for more details about installation.
- This motherboard is designed to support overclocking. Before attempting to overclock, please make sure that all other system components can tolerate overclocking. Any attempt to operate beyond product specifications is not recommended. MSI® does not guarantee the damages or risks caused by inadequate operation beyond product specifications.

## DIMM Slots

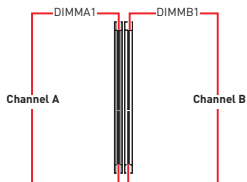
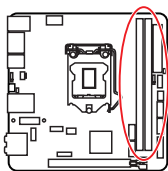

### Important

- Always insert memory modules in the **DIMMA1** slot first.
- Due to chipset resource usage, the available capacity of memory will be a little less than the amount of installed.
- Based on Intel CPU specification, the Memory DIMM voltage below 1.35V is suggested to protect the CPU.
- Please note that the maximum capacity of addressable memory is 4GB or less for 32-bit Windows OS due to the memory address limitation. Therefore, we recommended that you to install 64-bit Windows OS if you want to install more than 4GB memory on the motherboard.
- Some memory may operate at a lower frequency than the marked value when overclocking due to the memory frequency operates dependent on its Serial Presence Detect (SPD). Go to BIOS and find the **Memory Try It!** to set the memory frequency if you want to operate the memory at the marked or at a higher frequency.
- It is recommended to use a more efficient memory cooling system for full DIMMs installation or overclocking.
- The stability and compatibility of installed memory module depend on installed CPU and devices when overclocking.

## M2\_2: M.2 Wi-Fi module slot (Key E)

This slot is used for the M.2 Wi-Fi module.

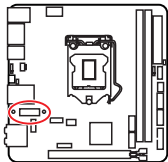

## PCI\_E1: PCIe Expansion Slot

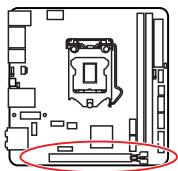

### Important

- If you install a large and heavy graphics card, you need to use a tool such as **MSI Gaming Series Graphics Card Bolster** to support its weight to prevent deformation of the slot.
- When adding or removing expansion cards, always turn off the power supply and unplug the power supply power cable from the power outlet. Read the expansion card's documentation to check for any necessary additional hardware or software changes.

## SATA1~4: SATA 6Gb/s Connectors

These connectors are SATA 6Gb/s interface ports. Each connector can connect to one SATA device.

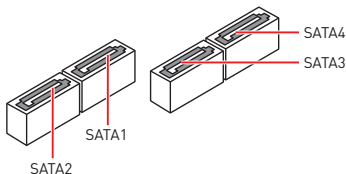
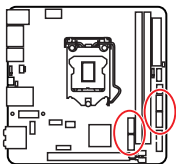

### Important

- Please do not fold the SATA cable at a 90-degree angle. Data loss may result during transmission otherwise.
- SATA cables have identical plugs on either sides of the cable. However, it is recommended that the flat connector be connected to the motherboard for space saving purposes.

## CPU\_PWR1, ATX\_PWR1: Power Connectors

These connectors allow you to connect an ATX power supply.

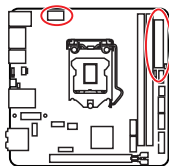

1	Ground	5	+12V
2	Ground	6	+12V
3	Ground	7	+12V
4	Ground	8	+12V

1	+3.3V	13	+3.3V
2	+3.3V	14	-12V
3	Ground	15	Ground
4	+5V	16	PS-ON#
5	Ground	17	Ground
6	+5V	18	Ground
7	Ground	19	Ground
8	PWR OK	20	Res
9	5VSB	21	+5V
10	+12V	22	+5V
11	+12V	23	+5V
12	+3.3V	24	Ground



### Important

Make sure that all the power cables are securely connected to a proper ATX power supply to ensure stable operation of the motherboard.

## JFP1, JFP2: Front Panel Connectors

These connectors connect to the switches and LEDs on the front panel.

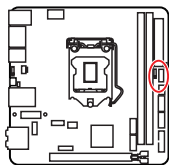

1	HDD LED +	2	Power LED +
3	HDD LED -	4	Power LED -
5	Reset Switch	6	Power Switch
7	Reset Switch	8	Power Switch
9	Reserved	10	No Pin

1	Speaker -	2	Buzzer +
3	Buzzer -	4	Speaker +

## JUSB1: USB 2.0 Connector

This connector allows you to connect USB 2.0 ports on the front panel.

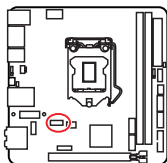

1	VCC	2	VCC
3	USB0-	4	USB1-
5	USB0+	6	USB1+
7	Ground	8	Ground
9	No Pin	10	NC

### Important

- Note that the VCC and Ground pins must be connected correctly to avoid possible damage.
- In order to recharge your iPad, iPhone and iPod through USB ports, please install MSI® SUPER CHARGER utility.

## JUSB2: USB 3.1 Gen1 Connector

This connector allows you to connect USB 3.1 Gen1 ports on the front panel.

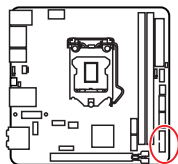

1	Power	11	USB2.0+
2	USB3_RX_DN	12	USB2.0-
3	USB3_RX_DP	13	Ground
4	Ground	14	USB3_TX_C_DP
5	USB3_TX_C_DN	15	USB3_TX_C_DN
6	USB3_TX_C_DP	16	Ground
7	Ground	17	USB3_RX_DP
8	USB2.0-	18	USB3_RX_DN
9	USB2.0+	19	Power
10	NC	20	No Pin

### Important

Note that the Power and Ground pins must be connected correctly to avoid possible damage.

## CPU\_FAN1, SYS\_FAN1: Fan Connectors

Fan connectors can be classified as PWM (Pulse Width Modulation) Mode or DC Mode. PWM Mode fan connectors provide constant 12V output and adjust fan speed with speed control signal. DC Mode fan connectors control fan speed by changing voltage. When you plug a 3-pin (Non-PWM) fan to a fan connector in PWM mode, the fan speed will always maintain at 100%, which might create a lot of noise. You can follow the instruction below to adjust the fan connector to PWM or DC Mode.

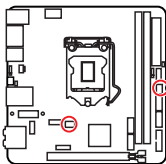

### Default PWM Mode fan connector



CPU\_FAN1

### Default DC Mode fan connector



SYS\_FAN1

## Switching fan mode and adjusting fan speed

You can switch between PWM mode and DC mode and adjust fan speed in **BIOS > HARDWARE MONITOR**.

Select **PWM** mode or **DC** mode

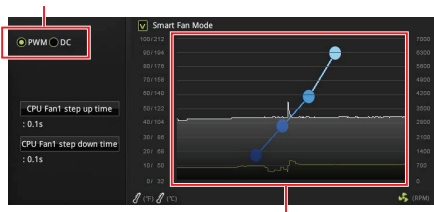

There are gradient points of the fan speed that allow you to adjust fan speed in relation to CPU temperature.



**Important**

Make sure fans are working properly after switching the PWM/ DC mode.

## Pin definition of fan connectors

PWM Mode pin definition			
1	Ground	2	+12V
3	Sense	4	Speed Control Signal

DC Mode pin definition			
1	Ground	2	Voltage Control
3	Sense	4	NC

## JAUD1: Front Audio Connector

This connector allows you to connect audio jacks on the front panel.

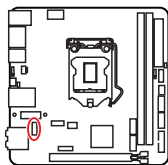

		10	9
		2	1
1	MIC L	2	Ground
3	MIC R	4	NC
5	Head Phone R	6	MIC Detection
7	SENSE_SEND	8	No Pin
9	Head Phone L	10	Head Phone Detection

## JCI1: Chassis Intrusion Connector

This connector allows you to connect the chassis intrusion switch cable.

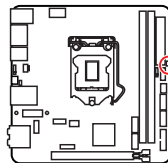

Normal  
(default)



Trigger the chassis  
intrusion event

### Using chassis intrusion detector

1. Connect the **JCI1** connector to the chassis intrusion switch/ sensor on the chassis.
2. Close the chassis cover.
3. Go to **BIOS > SETTINGS > Security > Chassis Intrusion Configuration**.
4. Set **Chassis Intrusion** to **Enabled**.
5. Press **F10** to save and exit and then press the **Enter** key to select **Yes**.
6. Once the chassis cover is opened again, a warning message will be displayed on screen when the computer is turned on.

### Resetting the chassis intrusion warning

1. Go to **BIOS > SETTINGS > Security > Chassis Intrusion Configuration**.
2. Set **Chassis Intrusion** to **Reset**.
3. Press **F10** to save and exit and then press the **Enter** key to select **Yes**.

## JTPM1: TPM Module Connector

This connector is for TPM (Trusted Platform Module). Please refer to the TPM security platform manual for more details and usages.

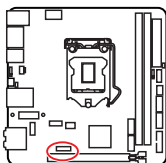

2		14	
1		13	
1	LPC Clock	2	3V Standby power
3	LPC Reset	4	3.3V Power
5	LPC address & data pin0	6	Serial IRQ
7	LPC address & data pin1	8	5V Power
9	LPC address & data pin2	10	No Pin
11	LPC address & data pin3	12	Ground
13	LPC Frame	14	Ground

## JBAT1: Clear CMOS (Reset BIOS) Jumper

There is CMOS memory onboard that is external powered from a battery located on the motherboard to save system configuration data. If you want to clear the system configuration, set the jumpers to clear the CMOS memory.

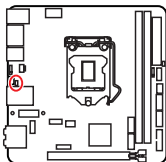

Keep Data  
(default)



Clear CMOS/  
Reset BIOS

### Resetting BIOS to default values

1. Power off the computer and unplug the power cord
2. Use a jumper cap to short JBAT1 for about 5-10 seconds.
3. Remove the jumper cap from JBAT1.
4. Plug the power cord and power on the computer.

## JRGB1, JCORSAIR1: RGB LED Connectors

The JRGB1 connector allows you to connect the 5050 RGB LED strips 12V. The JCORSAIR1 connector can be used to connect the CORSAIR Individually Addressable RGB LED strips 5V or CORSAIR RGB LED fans, and control the RGB effects with MSI's software.

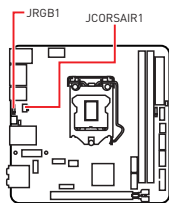

JRGB1			
1			
1	+12V	2	G
3	R	4	B

JCORSAIR1			
1			
1	+5V	2	Data
3	Ground		

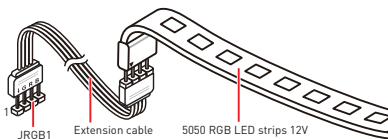

### Important

- The JRGB1 connector supports 5050 RGB LED strips (12V/G/R/B) with the maximum power rating of 3A (12V).
- Please keeping the LED strip shorter than 2 meters to prevent dimming.
- Always turn off the power supply and unplug the power cord from the power outlet before installing or removing the RGB LED strip.
- Please use MSI's software to control the extended LED strip.

# Onboard LEDs

## EZ Debug LEDs

These LEDs indicate the debug status of the motherboard.

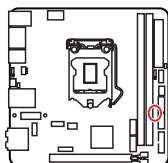

- CPU** - indicates CPU is not detected or fail.
- DRAM** - indicates DRAM is not detected or fail.
- VGA** - indicates GPU is not detected or fail.
- BOOT** - indicates the booting device is not detected or fail.

## DIMM LEDs

These LED indicate the memory modules are installed.

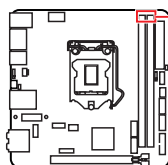

DIMM LEDs

## PCIe x16 slot LEDs

These LED indicate the PCIe x16 slots status.

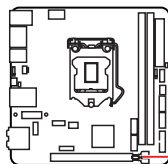

PCI\_E1 LED

LED Color	PCIe slot status
Red	x16 mode
White	x8, x4, x1 mode

# BIOS Setup

The default settings offer the optimal performance for system stability in normal conditions. You should **always keep the default settings** to avoid possible system damage or failure booting unless you are familiar with BIOS.

## Important

- BIOS items are continuously update for better system performance. Therefore, the description may be slightly different from the latest BIOS and should be for reference only. You could also refer to the **HELP** information panel for BIOS item description.
- The pictures in this chapter are for reference only and may vary from the product you purchased.

## Entering BIOS Setup

Please refer the following methods to enter BIOS setup.

- Press **Delete** key, when the **Press DEL key to enter Setup Menu, F11 to enter Boot Menu** message appears on the screen during the boot process.
- Use **MSI FAST BOOT** application. Click on **GO2BIOS** button and choose **OK**. The system will reboot and enter BIOS setup directly.



Click on **GO2BIOS**

## Function key

- F1:** General Help
  - F2:** Add/ Remove a favorite item
  - F3:** Enter Favorites menu
  - F4:** Enter CPU Specifications menu
  - F5:** Enter Memory-Z menu
  - F6:** Load optimized defaults
  - F7:** Switch between Advanced mode and EZ mode
  - F8:** Load Overclocking Profile
  - F9:** Save Overclocking Profile
  - F10:** Save Change and Reset\*
  - F12:** Take a screenshot and save it to USB flash drive [FAT/ FAT32 format only].
- Ctrl+F:** Enter Search page

\* When you press F10, a confirmation window appears and it provides the modification information. Select between Yes or No to confirm your choice.

## Resetting BIOS

You might need to restore the default BIOS setting to solve certain problems. There are several ways to reset BIOS:

- Go to BIOS and press **F6** to load optimized defaults.
- Short the **Clear CMOS** jumper on the motherboard.



*Be sure the computer is off before clearing CMOS data. Please refer to the **Clear CMOS** jumper section for resetting BIOS.*

## Updating BIOS

### Updating BIOS with M-FLASH

Before updating:

Please download the latest BIOS file that matches your motherboard model from MSI website. And then save the BIOS file into the USB flash drive.

Updating BIOS:

1. Press Del key to enter the BIOS Setup during POST.
2. Insert the USB flash drive that contains the update file into the computer.
3. Select the **M-FLASH** tab and click on **Yes** to reboot the system and enter the flash mode.
4. Select a BIOS file to perform the BIOS update process.
5. After the flashing process is 100% completed, the system will reboot automatically.

### Updating the BIOS with Live Update 6

Before updating:

Make sure the LAN driver is already installed and the Internet connection is set properly.

Updating BIOS:

1. Install and launch MSI LIVE UPDATE 6.
2. Select **BIOS Update**.
3. Click on **Scan** button.
4. Click on **Download** icon to download and install the latest BIOS file.
5. Click **Next** and choose **In Windows mode**. And then click **Next** and **Start** to start updating BIOS.
6. After the flashing process is 100% completed, the system will restart automatically.

## EZ Mode

At EZ mode, it provides the basic system information and allows you to configure the basic setting. To configure the advanced BIOS settings, please enter the Advanced Mode by pressing the **Setup Mode switch** or **F7** function key.

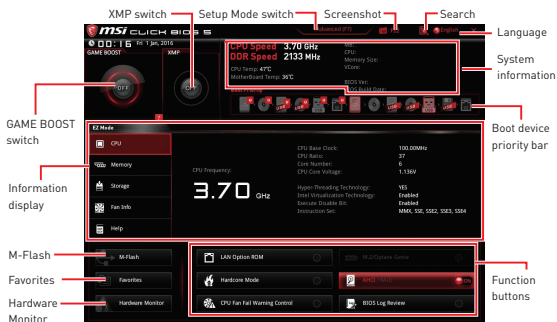

- **GAME BOOST switch** - click on it to toggle the **GAME BOOST** for OC.

### Important

*Please don't make any changes in OC menu and don't load defaults to keep the optimal performance and system stability after activating the GAME BOOST function.*

- **XMP switch** - click on the inner circle to enable/ disable the X.M.P. [Extreme Memory Profile]. Switch the outer circle to select the X.M.P. profile. This switch will only be available if the X.M.P. supported memory module is installed.
- **Setup Mode switch** - press this tab or the **F7** key to switch between Advanced mode and EZ mode.
- **Screenshot** - click on this tab or the **F12** key to take a screenshot and save it to USB flash drive (FAT/ FAT32 format only).

• **Search** - click on this tab or the **Ctrl+F** keys and the search page will show. It allows you to search by BIOS item name, enter the item name to find the item listing. Move the mouse over a blank space and right click the mouse to exit search page.

### Important

*In search page, only the F6, F10 and F12 function keys are available.*

- **Language** - allows you to select the language of BIOS setup.
- **System information** - shows the CPU/ DDR speed, CPU/ MB temperature, MB/ CPU type, memory size, CPU/ DDR voltage, BIOS version and build date.
- **Boot device priority bar** - you can move the device icons to change the boot priority. The boot priority from high to low is left to right.

• **Information display** - click on the **CPU, Memory, Storage, Fan Info** and **Help** buttons on left side to display related information.

• **Function buttons** - enable or disable the **LAN Option ROM, M.2/Optane Genie, HD audio controller, AHCI, RAID, CPU Fan Fail Warning Control** and **BIOS Log Review** by clicking on their respective button.

• **M-Flash** - click on this button to display the **M-Flash** menu that provides the way to update BIOS with a USB flash drive.

• **Hardware Monitor** - click on this button to display the **Hardware Monitor** menu that allows you to manually control the fan speed by percentage.

• **Favorites** - press the **Favorites** tab or the **F3** key to enter **Favorites** menu. It allows you to create personal BIOS menu where you can save and access favorite/ frequently-used BIOS setting items.

- **Default HomePage** - allows you to select a BIOS menu (e.g. SETTINGS, OC...,etc) as the BIOS home page.

- **Favorite1-5** - allows you to add the frequently-used/ favorite BIOS setting items in one page.

▪ **To add a BIOS item to a favorite page (Favorite 1-5)**

1. Move the mouse over a BIOS item not only on BIOS menu but also on search page.
2. Right-click or press **F2** key.
3. Choose a favorite page and click on **OK**.

▪ **To delete a BIOS item from favorite page**

1. Move the mouse over a BIOS item on favorite page (Favorite 1-5)
2. Right-click or press **F2** key.
3. Choose **Delete** and click on **OK**.

## Advanced Mode

Press **Setup Mode switch** or **F7** function key can switch between EZ Mode and Advanced Mode in BIOS setup.

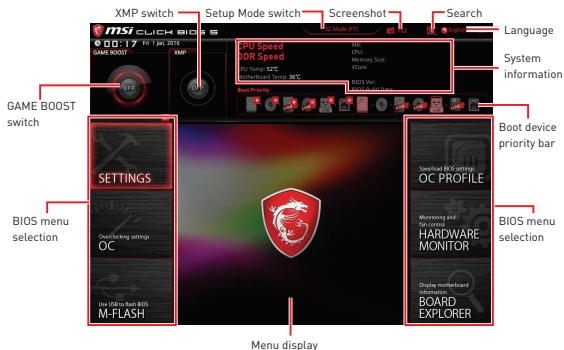

- **GAME BOOST switch/ XMP switch/ Setup Mode switch/ Screenshot/ Favorites/ Language/ System information/ Boot device priority bar** - please refer to the descriptions of EZ Mode Overview section.

- **BIOS menu selection** - the following options are available:

- **SETTINGS** - allows you to specify the parameters for chipset and boot devices.
- **OC** - allows you to adjust the frequency and voltage. Increasing the frequency may get better performance.
- **M-FLASH** - provides the way to update BIOS with a USB flash drive.
- **OC PROFILE** - allows you to manage overclocking profiles.
- **HARDWARE MONITOR** - allows you to set the speeds of fans and monitor voltages of system.
- **BOARD EXPLORER** - provides the information of installed devices on this motherboard.

- **Menu display** - provides BIOS setting items and information to be configured.

## SETTINGS

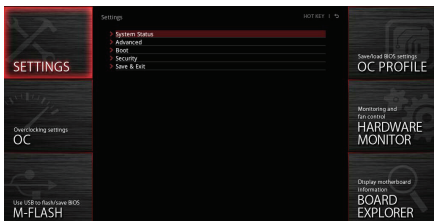

### System Status

#### ► System Date

Sets the system date. Use tab key to switch between date elements.

The format is <day> <month> <date> <year>.

- <day> Day of the week, from Sun to Sat, determined by BIOS. Read-only.
- <month> The month from Jan. through Dec.
- <date> The date from 1 to 31 can be keyed by numeric function keys.
- <year> The year can be adjusted by users.

#### ► System Time

Sets the system time. Use tab key to switch between time elements.

The time format is <hour> <minute> <second>.

#### ► SATA PortX/ M2\_X

Shows the information of connected SATA/ M.2 devices.



#### **Important**

*If the connected SATA device is not displayed, turn off computer and re-check SATA cable and power cable connections of the device and motherboard.*

#### ► System Information

Shows detailed system information, including CPU type, BIOS version, and Memory (read only).

#### ► DMI Information

Shows system information, desktop Board Information and chassis Information. (Read only).

## Advanced

#### ► PCI Subsystem Settings

Sets PCI, PCI express interface protocol and latency timer. Press **Enter** to enter the sub-menu.

#### ► PEG X - Max Link Speed [Auto]

Sets PCI Express protocol of PCIe x16 slots for matching different installed devices.

[Auto] This item will be configured automatically by BIOS.

[Gen1] Enables PCIe Gen1 support only.

[Gen2] Enables PCIe Gen2 support only.

[Gen3] Enables PCIe Gen3 support only.

#### ► PCI Latency Timer [32]

Sets latency timer of PCI interface device.

[Options: 32, 64, 96, 128, 160, 192, 224, 248 PCI Bus clocks]

#### ► Above 4G memory/ Crypto Currency mining [Disabled]

Enables or disables 64-bit capable devices to be decoded in above 4G address space. It is only available if the system supports 64-bit PCI decoding.

[Enabled] Allows you to utilize more than 4x GPUs.

[Disabled] Disables this function.

#### ► ACPI Settings

Sets ACPI parameters of onboard power LED behaviors. Press **Enter** to enter the sub-menu.

##### ► Power LED [Blinking]

Sets shining behaviors of the onboard Power LED.

[Dual Color] The power LED turns to another color to indicate the S3 state.

[Blinking] The power LED blinks to indicate the S3 state.

#### ► Integrated Peripherals

Sets integrated peripherals' parameters, such as LAN, HDD, USB and audio. Press **Enter** to enter the sub-menu.

##### ► Onboard LAN Controller [Enabled]

Enables or disables the onboard LAN controller.

##### ► LAN Option ROM [Disabled]

Enables or disables the legacy network Boot Option ROM for detailed settings. This item will appear when **Onboard LAN Controller** is enabled.

[Enabled] Enables the onboard LAN Boot ROM.

[Disabled] Disables the onboard LAN Boot ROM.

##### ► Network Stack [Disabled]

Sets UEFI network stack for optimizing IPv4 / IPv6 function.

[Enabled] Enables UEFI network stack.

[Disabled] Disables UEFI network stack.

##### ► Ipv4 PXE Support [Enabled]

When **Enabled**, the system UEFI network stack will support Ipv4 protocol. This item will appear when **Network Stack** is enabled.

[Enabled] Enables the Ipv4 PXE boot support.

[Disabled] Disables the Ipv4 PXE boot support.

#### ► **IPv6 PXE Support [Enabled]**

When **Enabled**, the system UEFI network stack will support IPv6 protocol. This item will appear when **Network Stack** is enabled.

[Enabled] Enables the IPv6 PXE boot support.

[Disabled] Disables the IPv6 PXE boot support.

#### ► **SATA Mode [AHCI Mode]**

Sets the operation mode of the onboard SATA controller.

[AHCI Mode] Specify the AHCI mode for SATA storage devices. AHCI (Advanced Host Controller Interface) offers some advanced features to enhance the speed and performance of SATA storage device, such as Native Command Queuing (NCQ) and hot-plugging.

[RAID Mode] Enables RAID function for SATA storage devices.

#### ► **SATAx Hot Plug [Disabled]**

Allows user to enable or disable the SATA hot plug support.

[Enabled] Enables hot plug support for the SATA ports.

[Disabled] Disables hot plug support for the SATA ports.

#### ► **HD Audio Controller [Enabled]**

Enables or disables the onboard High Definition Audio controller.

#### ► **HPET [Enabled]**

Enables or disables the HPET (High Precision Event Timers) support.

### ► **Integrated Graphics Configuration**

Adjusts integrated graphics settings for optimum system. Press **Enter** to enter the sub-menu.

#### ► **Initiate Graphic Adapter [PEG]**

Selects a graphics device as the primary boot device.

[IGD] Integrated Graphics Display.

[PEG] PCI-Express Graphics Device.

#### ► **IGD Multi-Monitor [Disabled]**

Enables or disables the multi-screen output from integrated graphics and external graphics card. This item appears when Initiate Graphic Adapter set to PEG.

[Enabled] Enables multi-screen function for both integrated and external graphics cards.

[Disabled] Disables this function.

### ► **USB Configuration**

Sets the onboard USB controller and device function. Press **Enter** to enter the sub-menu.

#### ► **USB Controller [Enabled]**

Enables or disables all USB controller.

#### ► **XHCI Hand-off [Disabled]**

Enables or disables XHCI hand-off support for the operating system without XHCI hand-off feature.

#### ► Legacy USB Support [Enabled]

Sets Legacy USB function support.

- [Auto] The system will automatically detect if any USB device is connected and enable the legacy USB support.
- [Enabled] Enable the USB support under legacy mode.
- [Disabled] The USB devices will be unavailable under legacy mode.

#### ► Power Management Setup

Sets system Power Management of ErP regulation and AC Power Loss behaviors. Press **Enter** to enter the sub-menu.

##### ► ErP Ready [Disabled]

Enables or disables the system power consumption according to ErP regulation.

- [Enabled] Optimize the system power consumption according to ErP regulation. It will not support S4 & S5 wake up by USB, PCI and PCIe devices.
- [Disabled] Disables this function.

##### ► Restore after AC Power Loss [Power Off]

Sets the system behaviors while encountering the AC power loss.

- [Power Off] Leaves the system in power off state after restoring AC power.
- [Power On] Boot up the system after restoring AC power.
- [Last State] Restores the system to the previous state (power on/ power off) before AC power loss.

##### ► System Power Fault Protection [Disabled]

Enables or disables the system to boot up when detecting abnormal voltage input.

- [Enabled] Protect the system from unexpected power operation and remain the shut down status.
- [Disabled] Disables this function.

#### ► Windows OS Configuration

Sets Windows OS detailed configuration and behaviors. Press **Enter** to enter the sub-menu.

##### ► Windows 10 WHQL Support [Disabled]

Enables the supports for Windows 10 or disables for other operating systems. Before enabling this item, make sure all installed devices & utilities (hardware & software) should meet the Windows 10 requirements.

- [Enabled] The system will switch to UEFI mode to meet the Windows requirement.
- [Disabled] Disables this function.

##### ► MSI Fast Boot [Disabled]

MSI Fast Boot is the fastest way to boot the system. It will disable more devices to speed up system boot time which is faster than the boot time of **Fast Boot**.

- [Enabled] Enables the MSI Fast Boot function to speed up booting time. And the following **Fast Boot** field will be disabled and fixed.
- [Disabled] Disables MSI Fast Boot.

## Important

When MSI Fast Boot is enabled, you can use **MSI FAST BOOT** application to enter BIOS setup if needed. Please refer **Entering BIOS Setup** section for details.

### ► Fast Boot [Enabled/ windows 10, Disabled/ windows7]

Enables or disables the fast boot feature for Windows 10. This item will only be available when **MSI Fast Boot** is disabled.

[Enabled] Enables the Fast Boot configuration to accelerate system boot time.

[Disabled] Disables the Fast Boot configuration.

### ► Internal GOP Configuration

Manages the onboard Graphics Output Protocol (GOP). Press **Enter** to enter the sub-menu. This sub-menu will appear when **Windows 10 WHQL Support** is enabled.

### ► Secure Boot

Sets the Windows secure boot to prevent the unauthorized accessing. Press **Enter** to enter the sub-menu. This sub-menu will appear when **Windows 10 WHQL Support** is enabled.

### ► Secure Boot Support [Disabled]

Enables or disables secure boot support.

[Enabled] Enables the secure boot function and allow you to set the secure boot settings.

[Disabled] Disables this function.

### ► Secure Boot Mode [Standard]

Selects the secure boot mode. This item is to select how the secure boot keys be loaded. This item appears when **Secure Boot Support** is enabled.

[Standard] The system will automatically load the secure keys from BIOS.

[Custom] Allows user to configure the secure boot settings and manually load the secure keys.

### ► Key Management

Manages the secure boot keys. Press <Enter> to enter the sub-menu. This sub-menu will appear when **Secure Boot Mode** sets to **Custom**.

### ► Wake Up Event Setup

Sets system wake up behaviors for different sleep modes. Press **Enter** to enter the sub-menu.

#### ► Wake Up Event By [BIOS]

Selects the wake up event by BIOS or operating system.

[BIOS] Activates the following items, set wake up events of these items.

[OS] The wake up events will be defined by OS.

#### ► Resume By RTC Alarm [Disabled]

Disables or enables the system wake up by RTC Alarm.

[Enabled] Enables the system to boot up on a scheduled time/ date.

[Disabled] Disables this function.

► **Date (of month) Alarm/ Time (hh:mm:ss) Alarm**

Sets RTC alarm date/ Time. If Resume By RTC Alarm is set to [Enabled], the system will automatically resume (boot up) on a specified date/hour/minute/second in these fields (using the + and - keys to select the date & time settings).

► **Resume By PCI-E Device [Disabled]**

Enables or disables the wake up function of installed PCI-E expansion cards, integrated LAN controllers or USB devices which are supported by third party integrated chips.

[Enabled] Enables the system to be awakened from the power saving modes when activity or input signal of PCIe device is detected.

[Disabled] Disables this function.

► **Resume By Onboard Intel LAN [Disabled]**

Enables or disables the system wake up by Onboard Intel LAN.

[Enabled] Enables the system to be awakened from the power saving modes when activity or input signal of Intel LAN device is detected.

[Disabled] Disables this function.

► **Resume by USB Device [Disabled]**

Enables or disables the system wake up by USB devices.

[Enabled] Enables the system to be awakened from sleep state when activity of USB device is detected.

[Disabled] Disables this function.

► **Resume From S3/S4/S5 by PS/2 Mouse [Disabled]**

Enables or disables the system wake up by PS/2 mouse.

[Enabled] Enables the system to be awakened from S3/ S4/ S5 state when activity of PS/2 mouse is detected.

[Disabled] Disables this function.

► **Resume From S3/S4/S5 by PS/2 Keyboard [Disabled]**

Enables or disables the system wake up by PS/2 keyboard.

[Any Key] Enables the system to be awakened from S3/ S4/ S5 state when activity of any key on PS/2 keyboard is detected.

[Hot Key] Enables the system to be awakened from S3/ S4/ S5 state when activity of hot key on PS/2 keyboard is detected.

[Disabled] Disables this function.

► **Intel ( R ) Ethernet Connection I219-V -(MAC**

Shows driver information and configuration of the ethernet controller parameter.

## Boot

Sets the sequence of system boot devices.

► **Full Screen Logo Display [Enabled]**

Enables or disables to show the full screen logo while system POST.

[Enabled] Shows the logo in full screen.

[Disabled] Shows the POST messages.

#### ► G02BIOS [Disabled]

Allows system to enter BIOS setup directly by pressing the Power button for 4 seconds upon bootup.

[Enabled] The system boots straight to the BIOS setup by long pressing the power button about 4 seconds when the system is off.

[Disabled] Disables this function.

#### ► Bootup NumLock State [On]

Select the keyboard NumLock state upon bootup.

#### ► Info Block effect [Unlock]

Sets the state of Help information block.

[Unlock] Sliding effect.

[Lock] Fix the **Help** information block on the screen.

#### ► AUTO CLR\_CMOS [Disabled]

Enables or disables the CMOS data to be resumed automatically when the booting process hang-up over 5 seconds.

#### ► Boot Mode Select [LEGACY+UEFI]

Sets the system boot mode from legacy or UEFI architecture depending on OS installation requirement. This item will become un-selectable and will be configured automatically by BIOS when **Windows 10 WHQL Support** is enabled.

[UEFI] Enables UEFI BIOS boot mode support only.

[LEGACY+UEFI] Enables both Legacy BIOS boot mode and UEFI BIOS boot mode.

#### ► FIXED BOOT ORDER Priorities

Sets device priority for system boot.

#### ► Boot Option Priorities

These items are used to prioritize the installed boot devices.

## Security

#### ► Administrator Password

Sets administrator password for system security. User has full rights to change the BIOS items with administrator password. After setting the administrator password, the state of this item will show "Installed".

#### ► User Password

Sets User Password for system security. User has limited rights to change the BIOS items with user password. This item will be available when administrator password is set. After setting the user password, the state of this item will show "Installed".

#### ► Password Check [Setup]

Selects a condition that will request the password.

[Setup] A password will be requested for entering the BIOS Setup.

[Boot] A password will be requested for booting the system.

#### ► Password Clear [Enabled]

Enables or disables the clear CMOS behavior to clear a set password.

[Enabled] The password will be erased after clear CMOS.

[Disabled] The password will always be kept.

#### **Important**

*When selecting the Administrator / User Password items, a password box will appear on the screen. Type the password then press **Enter**. The password typed now will replace any previous set password from CMOS memory. You will be prompted to confirm the password. You may also press **Esc** key to abort the selection.*

*To clear a set password, press **Enter** when you are prompted to enter a new password. A message will confirm the password is being disabled. Once the password is disabled, you can enter the setup and OS without authorization.*

#### ► Trusted Computing

Sets TPM (Trusted Platform Module) function.

##### ► Security Device Support [Disabled]

Enables or disables the TPM function to build the endorsement key for accessing the system.

##### ► TPM Device Selection [PTT]

Selects TPM device: PTT or dTPM.

[PTT] Select it for Firmware TPM (Intel Platform Trust technology)

[dTPM] Select it for Discrete TPM (Software TPM).

##### ► Device Select [Auto]

Sets the version of the TPM device. The version must be identical with the device. Sets to **Auto**, system will detect the TPM model automatically.

#### ► Chassis Intrusion Configuration

Press **Enter** to enter the sub-menu.

##### ► Chassis Intrusion [Disabled]

Enables or disables recording messages while the chassis is opened. This function is ready for the chassis equips a chassis intrusion switch.

[Enabled] Once the chassis is opened, the system will record and issue a warning message.

[Reset] Clear the warning message. After clearing the message, please return to **Enabled** or **Disabled**.

[Disabled] Disables this function.

## Save & Exit

### ▶ Discard Changes and Exit

Exit BIOS setup without saving any change.

### ▶ Save Changes and Reboot

Save all changes and reboot the system.

### ▶ Save Changes

Save current changes.

### ▶ Discard Changes

Discard all changes and restore to the previous values.

### ▶ Restore Defaults

Restore or load all default values.

### ▶ Boot Override

The installed bootable devices will appear on this menu, you can select one of them to be the boot device.



### **Important**

- Overclocking your PC manually is only recommended for advanced users.
- Overclocking is not guaranteed, and if done improperly, it could void your warranty or severely damage your hardware.
- If you are unfamiliar with overclocking, we advise you to use **GAME BOOST** function for easy overclocking.

#### ► **OC Explore Mode [Normal]**

Enables or disables to show the normal or expert version of OC settings.

[Normal] Provides the regular OC settings in BIOS setup.

[Expert] Provides the advanced OC settings for OC expert to configure in BIOS setup.

Note: We use \* as the symbol for the OC settings of Expert mode.

#### ► **CPU Ratio [Auto]**

Sets the CPU ratio that is used to determine CPU clock speed. This item can only be changed if the processor supports this function.

#### ► **Adjusted CPU Frequency**

Shows the adjusted CPU frequency. Read-only.

#### ► **CPU Ratio Offset When Running AVX [Auto]**

Sets a offset value to lower the CPU core ratio. It could be helpful for heat dissipation when running AVX instruction set. If set to Auto, BIOS will configure this setting automatically. This item appears when the installed CPU supports this function.

#### ► **Ring Ratio [Auto]**

Sets the ring ratio. The valid value range depends on the installed CPU.

#### ► **Adjusted Ring Frequency**

Shows the adjusted Ring frequency. Read-only.

#### ► **Misc Setting\***

Press Enter, + or - key to open or close the following 3 items related to CPU features.

► **EIST [Enabled]\***

Enables or disables the Enhanced Intel® SpeedStep Technology.

[Enabled] Enables the EIST to adjust CPU voltage and core frequency dynamically. It can decrease average power consumption and average heat production.

[Disabled] Disables EIST.

► **Intel Turbo Boost [Enabled]\***

Enables or disables the Intel® Turbo Boost. This item appears when the installed CPU supports this function.

[Enabled] Enables this function to boost CPU performance automatically above rated specifications when system request the highest performance state.

[Disabled] Disables this function.

► **Enhanced Turbo [Auto]\***

Enables or disables Enhanced Turbo function for all CPU cores to boost CPU performance. This item appears when the installed CPU supports this function.

[Auto] This setting will be configured automatically by BIOS.

[Enabled] All CPU cores would be increased to maximum turbo ratio.

[Disabled] Disables this function.

► **CPU Base Clock (MHz) [Default]**

Sets the CPU Base clock. You may overclock the CPU by adjusting this value. Please note that overclocking behavior and stability is not guaranteed. This item appears when a CPU that support this function is installed.

► **Extreme Memory Profile (X.M.P.) [Disabled]**

X.M.P. (Extreme Memory Profile) is the overclocking technology by memory module. Please enable XMP or select a profile of memory module for overclocking the memory. This item will be available when the memory modules that support X.M.P. is installed.

► **DRAM Frequency [Auto]**

Sets the DRAM frequency. Please note the overclocking behavior is not guaranteed.

► **Adjusted DRAM Frequency**

Shows the adjusted DRAM frequency. Read-only.

► **Memory Try It ! [Disabled]**

It can improve memory compatibility or performance by choosing optimized memory preset.

► **AIDA64 Memory Boost [Auto]**

Enables or disables the memory boost function for AIDA64 benchmark.

[Auto] The setting will be configured automatically by BIOS.

[Enabled] It might increase the memory read/ write performance in AIDA64 benchmark.

[Disabled] Disables this function.

### ► **Advanced DRAM Configuration**

Press **Enter** to enter the sub-menu. User can set the memory timing for each/all memory channel. The system may become unstable or unbootable after changing memory timing. If it occurs, please clear the CMOS data and restore the default settings. (Refer to the Clear CMOS jumper/ button section to clear the CMOS data, and enter the BIOS to load the default settings.)

### ► **DigitALL Power**

Press **Enter** to enter the sub-menu. Controls the digital powers related to CPU PWM.

#### ► **CPU Loadline Calibration Control [Auto]**

The CPU voltage will decrease proportionally according to CPU loading. Higher load-line calibration could get higher voltage and good overclocking performance, but increase the temperature of the CPU and VRM. If set to **Auto**, BIOS will configure this setting automatically.

#### ► **CPU Over Voltage Protection [Auto]**

Sets the voltage limit for CPU over-voltage protection. If set to **Auto**, BIOS will configure this setting automatically. Higher voltage provides less protection and may damage the system.

#### ► **CPU Under Voltage Protection [Auto]**

Sets the voltage limit for CPU under-voltage protection. If set to **Auto**, BIOS will configure this setting automatically. Higher voltage provides less protection and may damage the system.

#### ► **CPU Lite Load [Auto]**

This item is used to reduce the CPU voltage and temperature under non-overclocking and non-overvoltage conditions. Select higher mode if system is unstable. Auto is the recommended.

#### ► **CPU Over Current Protection [Auto]**

Sets the current limit for CPU over-current protection. If set to **Auto**, BIOS will configure this setting automatically.

#### ► **CPU Switching Frequency [Auto]**

Sets the PWM working speed to stabilize CPU Core voltage and minimize ripple range. Increasing the PWM working speed will cause higher temperature of MOSFET. So please make sure a cooling solution is well-prepared for MOSFET before you increase the value. If set to **Auto**, BIOS will configure this setting automatically.

#### ► **CPU VRM Over Temperature Protection [Enabled]**

Enables or disables the CPU VRM over temperature protection.

### ► **CPU Voltages control [Auto]**

These options allow you to set the voltages related to CPU. If set to **Auto**, BIOS will set these voltages automatically or you can set it manually.

### ► **DRAM Voltages control [Auto]**

These options allow you to set the voltages related to memory. If set to **Auto**, BIOS will set these voltages automatically or you can set it manually.

### ► PCH Voltages control [Auto]

These options allow you to set the voltages related to PCH. If set to **Auto**, BIOS will set these voltages automatically or you can set it manually.

### ► CPU Specifications

Press **Enter** to enter the sub-menu. This sub-menu displays the information of installed CPU. You can also access this information menu at any time by pressing [F4]. Read only.

#### ► CPU Technology Support

Press **Enter** to enter the sub-menu. The sub-menu shows the key features of installed CPU. Read only.

### ► MEMORY-Z

Press **Enter** to enter the sub-menu. This sub-menu displays all the settings and timings of installed memory. You can also access this information menu at any time by pressing [F5].

#### ► DIMMx Memory SPD

Press **Enter** to enter the sub-menu. The sub-menu displays the information of installed memory. Read only.

### ► CPU Features

Press **Enter** to enter the sub-menu.

#### ► Hyper-Threading [Enabled]

Intel Hyper-Threading technology treats the multi cores inside the processor as multi logical processors that can execute instructions simultaneously. In this way, the system performance is highly improved. This item appears when the installed CPU supports this technology.

[Enable] Enables Intel Hyper-Threading technology.

[Disabled] Disables this item if the system does not support HT function.

#### ► Active Processor Cores [All]

Allows you to select the number of active CPU cores.

#### ► Limit CPUID Maximum [Disabled]

Enables or disables the extended CPUID value.

[Enabled] BIOS limits the maximum CPUID input value to circumvent boot problems with older operating system that do not support the processor with extended CPUID value.

[Disabled] Use the actual maximum CPUID input value.

#### ► Intel Virtualization Tech [Enabled]

Enables or disables Intel Virtualization technology.

[Enabled] Enables Intel Virtualization technology and allows a platform to run multiple operating systems in independent partitions. The system can function as multiple systems virtually.

[Disabled] Disables this function.

► **Intel VT-D Tech [Disabled]**

Enables or disables Intel VT-D (Intel Virtualization for Directed I/O) technology.

► **Hardware Prefetcher [Enabled]**

Enables or disables the hardware prefetcher (MLC Streamer prefetcher).

[Enabled] Allows the hardware prefetcher to automatically pre-fetch data and instructions into L2 cache from memory for tuning the CPU performance.

[Disabled] Disables the hardware prefetcher.

► **Adjacent Cache Line Prefetch [Enabled]**

Enables or disables the CPU hardware prefetcher (MLC Spatial prefetcher).

[Enabled] Enables adjacent cache line prefetching for reducing the cache latency time and tuning the performance to the specific application.

[Disabled] Enables the requested cache line only.

► **CPU AES Instructions [Enabled]**

Enables or disables the CPU AES (Advanced Encryption Standard-New Instructions) support. This item appears when a CPU supports this function.

► **Intel Adaptive Thermal Monitor [Enabled]**

Enables or disables the Intel adaptive thermal monitor function to protect the CPU from overheating.

[Enabled] Throttles down the CPU core clock speed when the CPU is over the adaptive temperature.

[Disabled] Disables this function.

► **Intel C-State [Auto]**

Enables or disables the Intel C-state. C-state is a processor power management technology defined by ACPI.

[Auto] This setting will be configured automatically by BIOS.

[Enabled] Detects the idle state of system and reduce CPU power consumption accordingly.

[Disabled] Disable this function.

► **C1E Support [Disabled]**

Enables or disables the C1E function for power-saving in halt state. This item appears when **Intel C-State** is enabled.

[Enabled] Enables C1E function to reduce the CPU frequency and voltage for power-saving in halt state.

[Disabled] Disables this function.

► **Package C State limit [Auto]**

This item allows you to select a CPU C-state level for power-saving when system is idle. The options of C-state depend on the installed CPU. This item appears when **Intel C-State** is enabled.

► **CFG Lock [Enabled]**

Lock or un-lock the MSR 0xE2[15], CFG lock bit.

[Enabled] Locks the CFG lock bit.

[Disabled] Un-locks the CFG lock bit.

► **EIST [Enabled]**

Enables or disables the Enhanced Intel® SpeedStep Technology. This item will appear when **OC Explore Mode** is set to **Normal**.

[Enabled] Enables the EIST to adjust CPU voltage and core frequency dynamically. It can decrease average power consumption and average heat production.

[Disabled] Disables EIST.

► **Intel Turbo Boost [Enabled]**

Enables or disables the Intel® Turbo Boost. This item is for **Normal mode** and appears when a CPU that support Turbo Boost is installed.

[Enabled] Enables this function to boost CPU performance automatically over specification when system request the highest performance state.

[Disabled] Disables this function.

► **Long Duration Power Limit (W) [Auto]**

Sets the long duration TDP power limit for CPU in Turbo Boost mode.

► **Long Duration Maintained (s) [Auto]**

Sets the maintaining time for Long duration power Limit(W).

► **Short Duration Power Limit (W) [Auto]**

Sets the short duration TDP power limit for CPU in Turbo Boost mode.

► **CPU Current Limit (A) [Auto]**

Sets maximum current limit of CPU package in Turbo Boost mode. When the current is over the specified value, the CPU will automatically reduce the core frequency for reducing the current.

► **FCLK Frequency [Auto]**

Set FCLK Frequency for early power on. Lower FCLK frequency may help you to set higher base clock frequency.

► **DMI Link Speed [Auto]**

Sets DMI speed.

► **SW Guard Extensions (SGX) [Software Control]**

Enables or disables Intel SGX.

## M-FLASH

M-FLASH provides the way to update BIOS with a USB flash drive. Please download the latest BIOS file that matches your motherboard model from MSI website, save the BIOS file into your USB flash drive. And then follow the steps below to update BIOS.

1. Insert the USB flash drive that contains the update file into the computer.
2. Click on **M-FLASH** tab on BIOS setup screen or press **<Ctrl+F5>** during POST, a demand message will be prompted. Click on **Yes** to reboot and enter the flash mode.

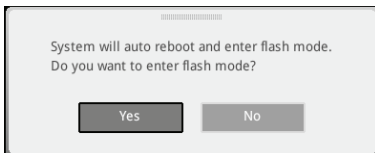

3. The system will enter the flash mode and a file selection menu will appear after rebooting.

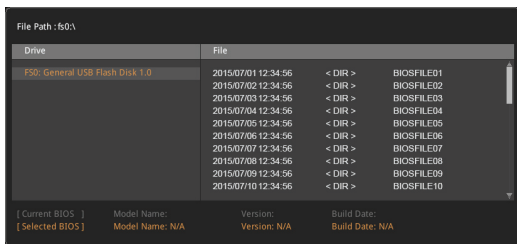

4. Select a BIOS file to perform the BIOS update process.
5. After the flashing process is 100% completed, the system will reboot automatically.

## OC PROFILE

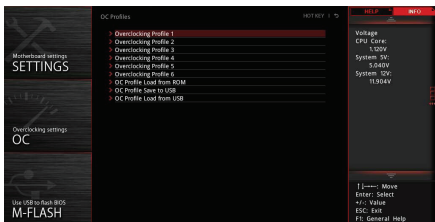

### ► Overclocking Profile 1/ 2/ 3/ 4/ 5/ 6

Overclocking Profile 1/ 2/ 3/ 4/ 5/ 6 management. Press <Enter> to enter the sub-menu.

#### ► Set Name for Overclocking Profile 1/ 2/ 3/ 4/ 5/ 6

Name the current overclocking profile.

#### ► Save Overclocking Profile 1/ 2/ 3/ 4/ 5/ 6

Save the current overclocking profile.

#### ► Load Overclocking Profile 1/ 2/ 3/ 4/ 5/ 6

Load the current overclocking profile.

#### ► Clear Overclocking Profile 1/ 2/ 3/ 4/ 5/ 6

Clear the current overclocking profile.

### ► OC Profile Load from ROM

Load OC profile from BIOS ROM.

### ► OC Profile Save to USB

Save OC profile to the USB flash drive. The USB flash drive should be FAT/ FAT32 format only.

### ► OC Profile Load from USB

Load OC profile from the USB flash drive. The USB flash drive should be FAT/ FAT32 format only.

## HARDWARE MONITOR

The screenshot shows the 'Hardware Monitor' BIOS utility. It is divided into several sections:

- Temperature & Speed:** Displays 'CPU 1' at 0RPM and 'System 1' at 3161RPM. It also shows temperature readings for CPU (51°C/123°F) and System (35°C/95°F).
- Fan Manage:** Features a 'Smart Fan Mode' section with a graph showing fan speed vs. temperature. Below the graph are controls for 'CPU Fan1 step up time' and 'CPU Fan1 step down time', both set to 0.1s. There are also radio buttons for 'PWM' and 'DC' fan control modes.
- Setting Buttons:** Includes buttons for 'All Full Speed(F)', 'All Set Default(D)', and 'All Set Cancel(C)'. The 'All Full Speed(F)' button is currently selected.
- Voltage display:** Shows voltage levels for 'CPU Core' (1.112V), 'System/12V' (11.904V), and 'System/5V' (5.040V).

### ► Temperature & Speed

Shows the current CPU temperature, system temperature and fans' speeds.

### ► Fan Manage

- **PWM** - allows you to select the PWM mode for fan operation.
- **DC** - allows you to select the DC mode for fan operation.
- **Fan step up/ down time** - allows you to set the period of fan step up/ down.
- **Smart Fan Mode field** - allows you to drag the gradient points to configure the fan target values for **Smart Fan** mode. **Smart Fan** can control the fan speed automatically depending on the CPU temperature to keep it within a specific range. If the current CPU temperature reaches the target value, the **Smart Fan** function will be activated.

### ! Important

- The changing will achieve after you save the changes and reboot the system.
- Make sure fans are working properly after switching the PWM/ DC mode.

### ► Settings Buttons

- **All Full Speed** - configures all fans to run at full operating speed.
- **All Set Default** - configures all fans to run at default operating speed.
- **All Set Cancel** - discards current changes and restores previous operating fan speeds .

### ► Voltage display

Shows the current voltages of CPU, system and memory.

# Software Description

Please download and update the latest utilities and drivers at [www.msi.com](http://www.msi.com)

## Installing Windows® 10

1. Power on the computer.
2. Insert the Windows® 10 disc into your optical drive.
3. Press the **Restart** button on the computer case.
4. Press **F11** key during the computer POST (Power-On Self Test) to get into Boot Menu.
5. Select your optical drive from the Boot Menu.
6. Press any key when screen shows **Press any key to boot from CD or DVD...** message.
7. Follow the instructions on the screen to install Windows® 10.

## Installing Drivers

1. Start up your computer in Windows® 10.
2. Insert MSI® Driver Disc into your optical drive.
3. The installer will automatically appear and it will find and list all necessary drivers.
4. Click **Install** button.
5. The software installation will then be in progress, after it has finished it will prompt you to restart.
6. Click **OK** button to finish.
7. Restart your computer.

## Installing Utilities

Before you install utilities, you must complete drivers installation.

1. Insert MSI® Driver Disc into your optical drive.
2. The installer will automatically appear.
3. Click **Utilities** tab.
4. Select the utilities you want to install.
5. Click **Install** button.
6. The utilities installation will then be in progress, after it has finished it will prompt you to restart.
7. Click **OK** button to finish.
8. Restart your computer.

## APP MANAGER

APP MANAGER is a handy management application for integration of MSI applications and software interface. Providing easy shortcut entrance and real-time update information of all the MSI software and applications.

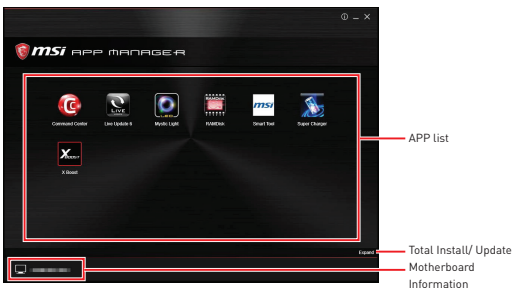

- **APP list** - shows all the applications and software be supported by this motherboard. An icon represents a entrance to the application.

- **Colorful icon** - a colorful icon means that the application had have been installed successfully and it is available. Double click on desired icon to access the application. A refresh icon  shows to inform you that the application has a update version.

- **Gray icon** - the icon with gray painting means that the application is not available and you have to install it if necessary. Double click on the gray icon and the update information will show. Click on the **INSTALL** button to install the application.

- **Motherboard Information** - shows the model name of motherboard.

- **Total Install/ Update** - click on this tab to update/ install all the applications.

### **Important**

Please note that, once you uninstall the APP MANAGER, all the MSI applications and software will be uninstalled simultaneously.

## LIVE UPDATE 6

LIVE UPDATE 6 is an application for the MSI® system to scan and download the latest drivers, BIOS and utilities. With LIVE UPDATE 6, you don't need to search the drivers on websites, and don't need to know the models of motherboard and graphics cards. LIVE UPDATE 6 will download the appropriate drivers automatically.

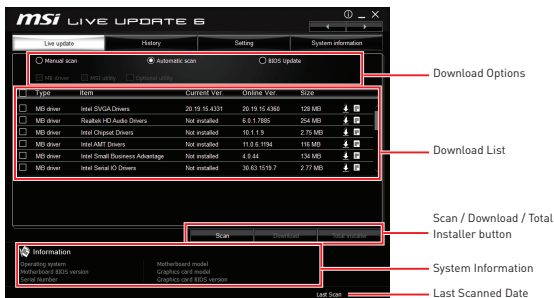

There are **Live Update**, **History**, **Setting** and **System Information** tabs at the top. You can click the tab to switch the control panel.

- **Live Update** - When you launch LIVE UPDATE 6, you will see the Live update tab at first. This tab allows you to select files to download. You can also read the relevant information by clicking the information icon  on the right of the item listed.
- **History** - shows the downloading history.
- **Setting** - allows you to specify the frequency that LIVE UPDATE 6 remind you to update.
- **System Information** - displays the information of the system.
- **FAQ** - shows Frequently Asked Questions.
- **Online Help** - shows Online Help information.

### Updating The System

This section describes how to update your system with LIVE UPDATE 6. Please follow the steps below:

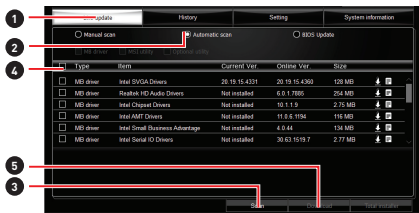

1. Select the **Live Update** tab.
2. Choose **Automatic scan**, system will automatically scan all the items and search for the latest update files. Or you can choose **Manual scan** and select the items you wish to scan.
3. Click the **Scan** button at the bottom. It may take several moments to complete the process.
4. When the download list appears, please select the items you intend to update.
5. Click **Download** button at the bottom.
6. When **Save Path** prompt, you can specify a download directory.

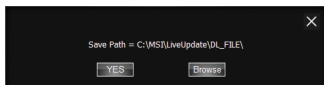

7. When downloading you will see the screen below. It may take several moments to complete the process.

Type	Item	Latest Ver	Size	Download
MSI utility	Fast Boot	1.0.1.5	1.52 MB	<div style="width: 50%;"></div> 46 %
MSI utility	Super Charger	1.2.0.26	3.21 MB	

8. To install the applications, simply unpack the packages and install.

## Total Installer

Total Installer is a convenient feature to simplify frequent installing procedure. To use Total Installer:

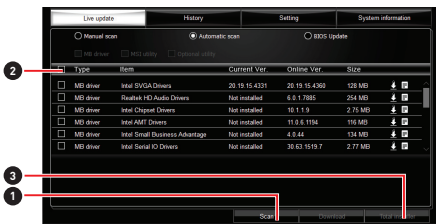

1. **Scan** updates in **Live Update** tab.
2. Check the **Select All** check-box you intend to update.
3. Click the **Total Installer** button. LIVE UPDATE 6 will automatically install them.
4. When prompted, click **OK** to complete the Total Installer procedure
5. Reboot your system.

## COMMAND CENTER

COMMAND CENTER is an user-friendly software and exclusively developed by MSI, helping users to adjust system settings and monitor status under OS. With the help of COMMAND CENTER, making it possible to achieve easier and efficient monitoring process and adjustments than that under BIOS. In addition, the COMMAND CENTER can be a server for mobile remote control application.

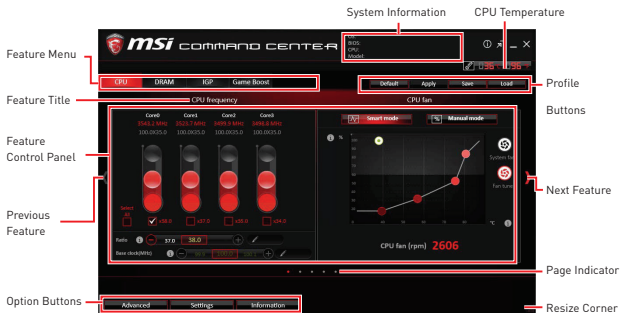

### Profile Buttons



- **Default** - load the default values for the current feature.
- **Apply** - apply your changes.
- **Save** - store values in the file with individual file extension.
- **Load** - load the values from the file.

### Important

Every time you shut down the system, the configured setting will be restored to the factory default. If you want to use the saved settings, you have to load it every time by clicking the **Load** and **Apply** buttons.

### CPU Frequency

CPU Frequency control panel allows you to change CPU Ratio and Base clock. You can see the current frequency of each CPU core on the top of the panel.



## CPU Fan

CPU Fan control panel provides **Smart mode** and **Manual Mode**. You can switch the control mode by clicking the **Smart Mode** and **Manual Mode** buttons on the top of the CPU Fan control panel.

- **Manual Mode** - allows you to manually control the CPU fan speed by percentage.
- **Smart Mode** - a linear fan speed control feature. The control panel contains 4 dots allows you to drag and adjust the Smart Speed slopes. The fan speed will be changed along these lines with CPU temperature. The white dot will create strip chart in real time.
- **System Fan Button** - to open the system fan control panel in new window.
- **Fan Tune Button** - to automatically optimize the smart fan setting.

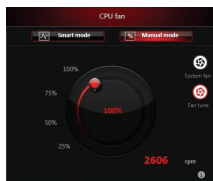

Manual Mode

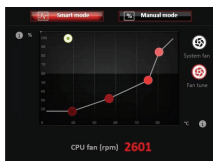

Smart Mode

## CPU Voltage

CPU Voltage control panel allows you to control the CPU voltage.

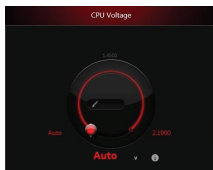

## DRAM Frequency & DRAM Voltage

- **DRAM Frequency** - Shows the DRAM clock, ratio and frequency.
- **DRAM Voltage** - Allows you to adjust the DRAM voltage. The risky values are displayed in red.



## IGP Frequency & GT Voltage

- **IGP Frequency** - Allows you to adjust the IGP ratio, and shows the IGP clock, ratio and frequency.
- **GT Voltage** - Allows you to adjust the GT voltage. The risky values are displayed in red.



## GAME BOOST

GAME BOOST provides a specified CPU frequency for overclocking the CPU.



### Option Buttons - Advanced

When click the **Advanced** button, The **Voltage**, **Fan** and **DRAM** icons will appear.



- **Voltage** - allows you to adjust advanced voltage values of CPU and chipset.
- **Fan** - allows you to control the system fans speed.
- **DRAM** - shows the current Advanced DRAM parameters, and allows you to change the settings by selecting values from the drop-down menu on the right hand side.
- **Sensor** - allows you to monitor your motherboard temperature and fan speed with the virtual thermal image. You can drag and drop the fan icons to new locations. When you press the **Cooling** button, all fans will run at full speed.

### Option Buttons - Setting

When click the **Setting** button, The **Record**, **Warning** and **Mobile Control** icons will appear.



- **Record** - allows you to monitor the status of voltage, fan speed and temperature in real time.
  - To filter record charts, select the check box next to the items.
  - When click the **Play** button, the chart pane will start to show the recording chart. If you want to check the value of a specific spot on chart, please move the orange vertical line to the spot.
  - History Record stores the data and names with date and time.
  - To make a history record: Select items and click the **Record** button. When finished, click the **Record** button again. The data will be stored in the drop-down menu.
  - To load a record, click the drop-down menu and select one from the list.
  - To delete a record, select the record that you want to delete, and click the **Trash Can** icon.

• **Warning** - contains fields of voltage, fan speed and temperature for you to set the threshold values. When system detects the status over your settings, a warning message will pop-up.



• **Mobile Control** - is only available for the motherboard with the built-in WiFi module. It allows you to enable/disable the COMMAND CENTER Remote Server. Please refer to the instruction on the Mobile Control control panel.

• **To start remote control: (optional)**

1. Download and install **MSI® COMMAND CENTER APP** to your mobile device.
2. Enable **COMMAND CENTER Remote Server** on the **Mobile Control** panel.
3. Enable **SoftAP Management**.
4. Enter **SSID** and **Password**, and then click the **Apply** button.
5. Activate Wi-Fi® on your mobile device and connect to SoftAP with the SSID.
6. Run **MSI® COMMAND CENTER APP** on your mobile device.
7. Find the IP address on the **SoftAP Management Setting** area, and enter the IP address on your **MSI® COMMAND CENTER APP** to link your system.
8. Press **Refresh** on the **MSI® COMMAND CENTER APP** to verify that monitoring and OC functions are working properly.

**Option Buttons - Information**

When click the **Information** button, The **Motherboard, CPU, Memory** and **HW monitor** icons will appear.



You can click the icons to open the related information.

**Gadget Mode**

COMMAND CENTER provides a gadget mode to monitor the system status. You can switch between gadget mode and full mode by clicking the arrow icon  on the top left.

• **To arrange gadgets:**

1. Click the **Spanner icon**  on the Gadget mode, a configuration panel will slide out.
2. Select the check box next to the items.
3. Click the **Close** button.

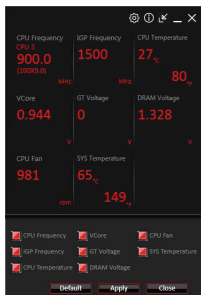

## GAMING APP

GAMING APP is an application designed to quickly control your system for improving gaming performance.

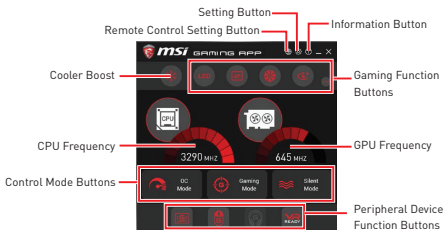

- **Setting Button** - allows you to choose running GAMING APP when Windows starts or let GAMING APP to overwrite the VGA fan control function.
- **Information Button** - shows the information of this application.
- **CPU Frequency** - shows the current CPU frequency.
- **GPU Frequency** - shows the current GPU frequency.
- **Control Mode Buttons**
  - **OC Mode** - apply turbo frequency to CPU and OC frequency to GPU.
  - **Gaming Mode** - automatically optimize the CPU ratio and the GPU clock.
  - **Silent Mode** - reverts the CPU ratio and GPU clock to the default values.
- **Gaming Function Buttons** - allows you to use **LED Effect**, **OSD**, **Eye Rest** and **Dragon Eye** functions.
- **Peripheral Device Function Buttons** - allows you to set the **Gaming Hotkey**, **Mouse Master** and **VR Ready** functions.
- **Remote Control Setting Button** - available for the motherboards with built-in or discrete WiFi module. It allows you to set up **Name** and **Password** to link the android device and the motherboard. Please follow the steps below to complete the remote control setting.
  1. Download and install the **MSI® GAMING APP** APP to your android device.
  2. Set up a set of **Name** and **Password** on the **Remote Control Setting** panel, and then click the **Apply** button.
  3. Connect your android device and motherboard to the same local area network.
  4. Run **MSI® GAMING APP** APP on your android device.
  5. Press the **Remote Control Setting** icon on the **MSI® GAMING APP** APP to find the paired device **Name** you set in the **Remote Control Setting** panel.
  6. Enter the **Password** you set in the **Remote Control Setting** panel.
  7. Finally, you can use the **MSI® GAMING APP** APP to control your motherboard with the android device.

## OSD Setting Panel

Use the OSD setting panel to specify information within on-screen display (OSD).



- **Apply Button** - applies above settings to OSD.

## Eye Rest

Eye Rest allows you to optimize the display on your monitor.

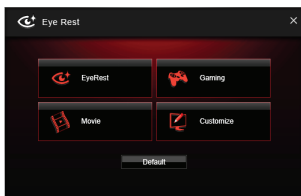

- **EyeRest** - reduces blue-light of your LED backlit screen, in order to protect your eyes.
- **Gaming** - automatically increase contrast ratio of your screen.
- **Movie** - automatically increase dynamic contrast ratio of your screen.
- **Customize** - allows you to adjust gamma, contrast and color balance for your screen.
- **Default** - loads the default settings.

## VR Ready

It will optimize the performance of your system to ensure everything is VR Ready.



- **VR ON/ OFF** -enables or disables VR settings.
- **Applications** - appears when you turn on the VR support. It allows you to close some applications to optimize the system for better VR experience.

## Gaming Hotkey

Gaming Hotkey provides instant control of the system through user defined hotkeys.

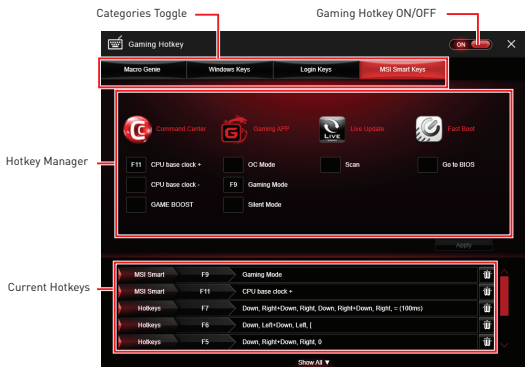

- **Gaming Hotkey ON/OFF** - allows you to turn ON/OFF the Gaming Hotkey function.
- **Categories Toggle** - allows you to toggle over the Hotkey categories.
  - **Macro Genie** - provides the keyboard and mouse macro record function and allows you to define the hotkeys for the macro recorder.
    1. Click on the **Record** button to start the keyboard and mouse macro recorder.
    2. Click on the **Stop** button to stop the recorder.
    3. Key-in a file name and set-up the parameter for the macro.
    4. Finally, click on the **Save** button to save the recorded macro.
  - **Windows Keys** - allows you to define hotkeys to replace Windows default keyboard shortcuts.
  - **Login Keys** - provides hotkey login function.
  - **MSI Smart Keys** - allows you to define hotkeys for MSI Smart Keys.
- **Hotkey Manager** - allows you to create, edit and delete hotkeys.
- **Current Hotkeys** - shows all existing hotkeys.

### **Important**

- The **Caps Lock**, **Num Lock**, **Scroll Lock**, **Window Home**, **Application** and **BackSpace** keys can not be used as Hotkeys.
- Some key combinations are reserved for use by Microsoft Windows and can not be assigned as a hotkey.

## Mouse Master

Mouse Master provides mouse macro function. You can also use it to change DPI of your mouse.

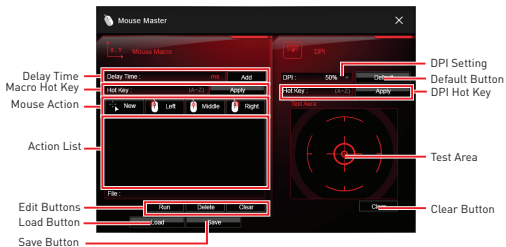

- **Delay Time** - allows you to apply a delay time in mouse macro.
- **Macro Hot Key** - allows you to assign a hotkey from A to Z to activate the macro.
- **Mouse Action** - assigns mouse actions to the macro.
  - **New** - captures the mouse coordinate and add to the macro.
  - **Left** - add a left-click to the macro.
  - **Middle** - add a middle-click to the macro.
  - **Right** - add a right-click to the macro.
- **Action List** - shows the actions of the current macro.
- **Edit Buttons** - there 3 buttons for editing the macro.
  - **Run** - activates the macro.
  - **Delete** - removes the selected action from the macro.
  - **Clear** - removes all actions from the macro.
- **Load Button** - allows you to load a macro.
- **Save Button** - allows you to save the macro to a file.
- **DPI Setting** - allows you select the mouse DPI from the drop-down menu.
- **Default Button** - reverts to the default DPI setting.
- **DPI Hot Key** - allows you to assign a hotkey from A to Z to activate the DPI setting. Please note that you must hold the hotkey to keep the DPI setting. When you release the hotkey, the DPI setting will be reverted to default.
- **Test Area** - allows you to test the mouse movement.
- **Clear Button** - clears the test area.

## X-BOOST

The MSI **X-BOOST** allows you to select the system performance mode to meet your current system environment or support faster storage access speed for your external storage or memory cards.

### Easy

In **Easy** page, you can select one system performance mode to meet the current system environment.

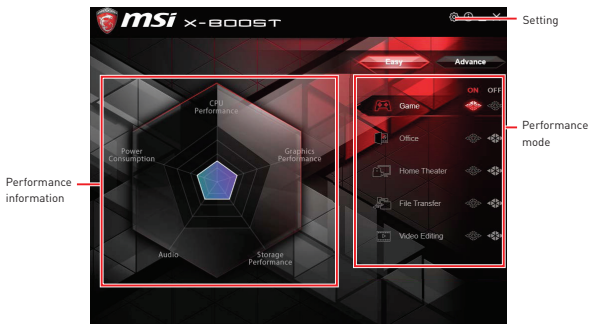

- **Performance mode** - moves over the mouse to any one of performance mode and click on the **ON** button to enable it.

### **Important**

The **Customize** mode is the default of system performance.

- **Performance information** - displays the system performance diagram of enabled mode.
- **Setting** - enables or disables **Run X-BOOST** when windows starts.

## Advance

In **Advance** page, you can enable the **USB SPEED UP**, the **STORAGE BOOST** and **VR BOOST**.

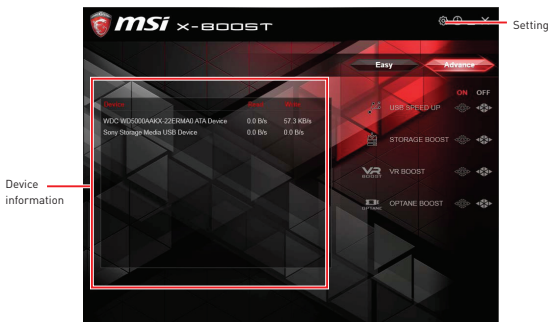

- **Device information** - displays the information and current transfer rates/ access speeds of USB/ storage devices.

- **Setting** - enables or disables **Run X-BOOST when windows starts**.

- **USB SPEED UP** - supports faster data transfer rates of the USB storage devices.

- **STORAGE BOOST** - supports faster access speed of storage device.

- **VR BOOST** - provides the optimized settings to boost the system for better VR experience.

- **OPTANE BOOST** - supports faster access speed of Intel Optane memory (require a reboot).

### **Important**

- Please note that you can only select one mode at a time from Easy or Advance page as **MSI X-BOOST** function.

- The improved transfer rate/ access speed will vary with the USB/ storage device.

## MYSTICLIGHT

MYSTICLIGHT is an application allows you to control LED lights of MSI products.

### Main Screen

The Main screen is used to configure what devices need to be synchronized and LED light effect options.

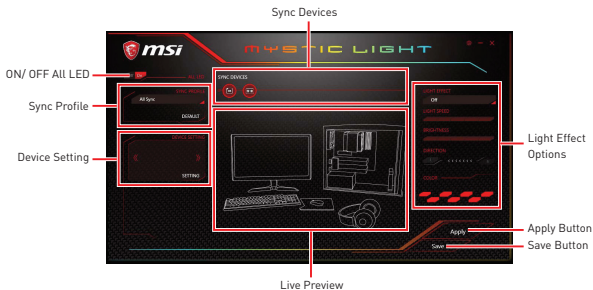

- **ON/OFF ALL LED** - allows you to turn ON/ OFF all LED lights of sync devices.
- **Sync Devices** - allows you to select devices to sync by clicking the device's icon on the Sync Device bar. The lighting effect of the sync devices will be controlled by the main screen.
- **Live Preview** - gives you the full experience of your configuration's look, feel while you are editing it.
- **Light Effect Options** - allow you to customize lighting effect of the sync devices.
- **Apply Button** - applies lighting effect settings.
- **Sync Profile** - manages sets of sync device lighting effect settings.
  - **All Sync** - all devices are synchronized to the main lighting effect settings.
  - **Individual** - all devices lighting effects are applied to their respective settings.
  - **Profile01~03** - selected sync devices lighting effects are synchronized to the main lighting effect settings.
- **Save Button** - saves sync device settings and lighting effect settings to the current Sync Profile.
- **Device Setting** - switches to the other supported products.

## Motherboard Screen

The motherboard screen is used to configure the LED light effect of the motherboard.

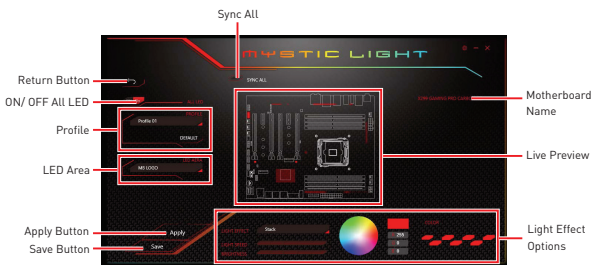

**Note:** The motherboard picture and name may vary according to different models.

- **Return Button** - returns to the main screen.
- **ON/OFF All LED** - allows you to turn ON/ OFF all LED lights of the motherboard.
- **Sync All** - allows you to synchronize all LED light effect of the motherboard.
- **Motherboard Name** - shows the name of the motherboard.
- **Live Preview** - gives you the full experience of your configuration's look, feel while you are editing it.
- **Light Effect Options** - allow you to customize lighting effect of the sync devices.
- **Apply Button** - applies lighting effect settings.
- **Profile** - manages sets of motherboard LED light effect settings.
- **Save Button** - saves sync device settings and lighting effect settings to the current profile.
- **LED Area** - switches to the other LED area on the motherboard.

## MSI SMART TOOL

MSI SMART TOOL is a convenient tool that can help you to create your Windows installation USB flash drive with USB 3.0 drivers, and it can also create a software RAID.

### Main menu

After installing and activating MSI SMART TOOL, it will display a main menu for you to choose **Win7 Smart Tool** or **Software RAID**. Note that the Software RAID is only available when your system equipped with at least 3 hard-disk drives (1 system disk and 2 data disks).

### WIN7 SMART TOOL

Before you can create your Windows installation USB flash drive, you'll need to have your Windows Installation DVD or ISO file, and also have a minimum of a 8GB USB flash drive to create your installer. Be sure to backup files on the USB drive, this process will erase it.



To create the Windows installation USB drive:

#### Step1. Choose source folder

- In the **Source folder** box, type the name and path of your Windows ISO file, or click **Browse** button and select the file from the dialog box. (This option will copy all Windows installation files and USB 3.0 drivers)
- If you already have the Windows Installation USB flash drive and just want to add USB 3.0 drivers on it, you can choose **Add USB drivers**.

#### Step2. Choose Storage device

- Choose **USB storage** and select your USB flash drive in the drop-down list. In case the USB flash drive is not listed, click the **Refresh Drive** button.
- If you want to install Windows on the PCIe M.2 RAID that was created by **BIOS > M.2 Genie** (please refer to BIOS Setup Section for details), check the **M.2 Genie** checkbox to copy iRST drivers to the USB flash drive.
- Click **Start**.



*You can also create an installer ISO image file by selecting the **ISO destination** in Step2, and then burn it onto the DVD. However, this method does not support **M.2 Genie**.*

## SOFTWARE RAID

This utility allows you to create a software RAID in Windows system.



To create a software RAID:

1. Use checkboxes to select the disks you want included in your RAID.
2. Choose **Speed Up** or **Backup** for RAID type.
  - Speed Up = RAID0
  - Backup = RAID1
3. Click **Start**.
4. When prompt **Finish!**, click **OK**.

 **Important**

*Software RAID can't include the system disk.*

## RAMDISK

RAMDISK creates a virtual RAM drive using the available memory in your computer, the performance of the RAMDISK is faster than an SSD and hard drive. RAMDISK allows you to store any temporary information on it. Furthermore, using the RAMDISK will extend your SSD's life by sparing it from excessive reading and writing.

### Creating a RAM Disk

When **RAMDISK** is started, it will create a default RAM disk. If you want to change settings, refer to following instructions.

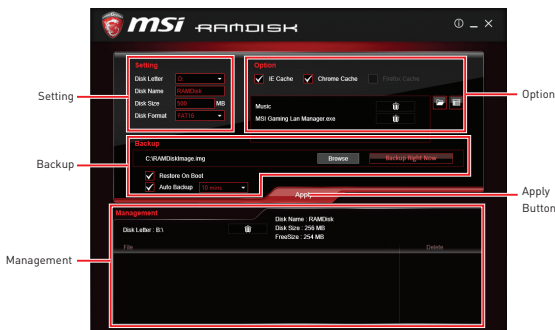

- **Setting** - specify **Letter**, **Name**, **Size** and **Format** of the RAM disk.
- **Option** - select browser temporary files to save/load on the RAM disk. You can also add software files to improve reading speed.
- **Backup** - specify backup and restore settings to prevent data loss. All files will be lost each time the RAMDISK is stopped if you do not backup.
  - **Browse Button** - set the path to the image file.
  - **Backup Right Now Button** - manually backup files.
  - **Restore On Boot** - check this box to have the image file loaded automatically when RAMDISK starts.
  - **Auto Backup** - check this box to backup automatically over a period of time.
- **Apply Button** - allows you to apply changes.
- **Management** - shows RAMDISK information and allows you to delete files.

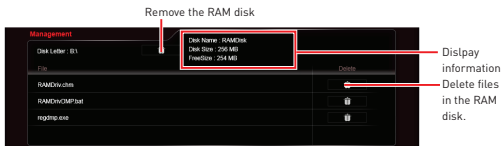

## GAMING LAN MANAGER

GAMING LAN MANAGER is an utility for traffic shaping for the Windows 10. It can keep your internet fast during heavy upload/ download and improve your ping for online games. If your motherboard has a Wi-Fi module, GAMING LAN MANAGER provides virtual access point function for traffic shaping for your mobile devices.

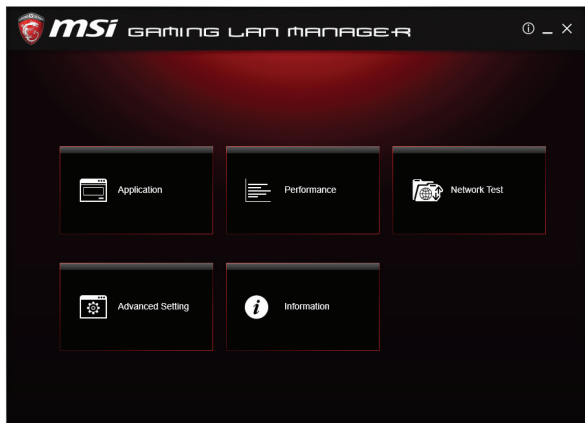

- **Applications** - displays currently using network bandwidth applications. You can prioritize Games, Medias or File sharing programs as high as possible.
- **Performance** - shows top 5 applications by total traffic, allows you to monitor network bandwidth usage.
- **Network Test** - allows you to setup bandwidth control.
- **Advanced Setting** - allows you to expand RWIN to accelerate download speed. You can also block IP address and setup virtual access point.
- **Information** - shows version information.

### Configuring Bandwidth

This section describes how to configure Internet Provider Speed. You can configure default internet upload and download bandwidth from the Network Test tab on the GAMING LAN MANAGER window.

#### **Important**

*Before using the GAMING LAN MANAGER for the first time, you should use the **Test Network Speed** button which runs a speed test of your current total Internet bandwidth delivered through your Internet service provider.*

## Speed Testing

The speed testing is used to optimize bandwidth usage. To test the Upload and Download speed, please follow the steps below:

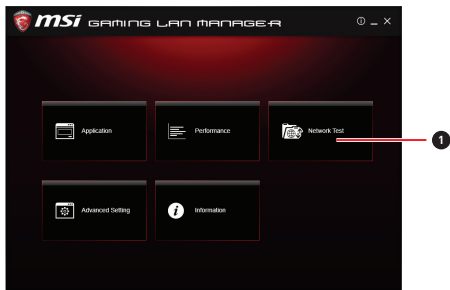

1. Click the **Network Test** block in GAMING LAN MANAGER.

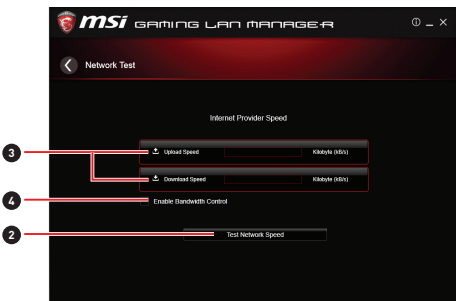

2. Click **Test Network Speed** button. The test takes several minutes to test your network speed.
3. Enter the testing results into **Upload Speed** and **Download Speed** fields.
4. Check the **Enable Bandwidth Control** to allow the GAMING LAN MANAGER to manage the bandwidth.

## DRAGON EYE

DRAGON EYE allows you to watch game guides, tutorials, live match or tournament stream while gaming. In game, you can use hotkeys to control/adjust the settings of DRAGON EYE.



- **On / Off Switch** - enables or disables Dragon Eye during your gaming sessions. Switch it on before you launch the game in order to watch video while playing.
- **Video List** - contains the videos you can select to watch. You can add videos or streams to the list by pasting their URL into the input bar and hit+.
- **Size Settings** - allows you to select the size of the Dragon Eye video content displayed on-screen when you're playing a game. There are three options available:
  - WQVGA [Small – 400×240]
  - HVGAW [Medium – 640×360]
  - WVGA [Large – 768×480]
- **Position Settings** - allows you to determine how you want to position your DRAGON EYE windows on screen to avoid interfering your gaming experience.
- **Help** - If you want to watch the video tutorial for Dragon Eye or want to see if your game is supported, press this button and the help window will be shown.
- **Transparency Settings** - allows you to set the transparency of your Dragon Eye video.
  - 0 = opaque | 100 = transparent.
- **Hotkeys Information** - In this information section you can find the hotkeys for Dragon Eye. There are three hotkeys:
  - **Alt+F9** - switches mouse focus between video window and game itself. (Direct interface to adjust progress bar, volume and other settings of video during the game)
  - **Alt+F10** - turns on/off video window .
  - **Alt+F11** - adjusts transparency of video clip.

**NOTE:** To customize hotkey, simply select the hotkey icon and then press the keys combination you want to use as a hotkey.

## Nahimic 2

Nahimic 2 is designed to offer the best audio experience it contains 6 audio effects, 3 microphone effects, HD Audio Recorder2 and Sound Tracker.

### Installation and Update

Nahimic 2 is included in the audio driver. If you need to install it or update it, please use the **Driver Disc** with your motherboard or download the driver from MSI's official website.

### Audio Tab

From this tab, you can access all of Nahimic 2's audio effects, audio profiles and settings.



- **Display & Volume** - displays the type of audio rendering device currently being used as output, as well as its current volume.
  - **Mute** - mutes the current audio output device.
  - **Device properties** - allows you to change the format, sample rate, bit rate and the channel gain of the current device [if these options are available for the current device]. Clicks on this button and a device properties panel will show.
- **Profiles** - allows you to adjust the 6 audio effects to your current listening experience.
  - **Gaming** - allows you to choose an audio profile to fit your gaming experience.
  - **Multimedia** - allows you to choose an audio profile to fit your everyday experience.
- **Audio Effects** - allows you to separately control any of the 6 audio effects.
  - **Bass Boost** - increases the energy in low frequencies up to +12 dB.
  - **Virtual Surround**
    - **Gaming and Movies** - virtualizes the multichannel audio stream and downmixes it in order to retrieve a multichannel listening experience over your stereo headphones or speakers.
    - **Music** - expands the stereo for a wider sound stage.
  - **Reverb** - increases the feeling of space by applying different types of reverbs corresponding to different room sizes.

- **Treble Enhancer** - Increases the energy in high frequencies up to +12 dB.
- **Smart Loudness** - maintains a constant volume for all elements of the audio experience to making them all sound softer, balanced or louder.
- **Voice Clarity** - boosts the speech in movies, video games and incoming communication from +0 through +12 dB [0 to 100%].
- **Reset Button** - restores the current profile to its default values.
- **On/Off Button** - allows you to turn on and off all Nahimic 2's effects in one click.
- **EQ Profile Page** - by clicking the arrow button, you can also access a second page that contains the x10 bands EQ and EQ profiles.

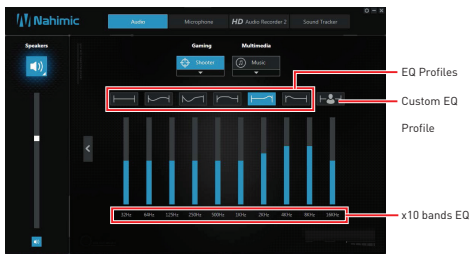

- **EQ Profiles** - allows you to choose between 6 EQ profiles to fit your audio experience
- **Custom EQ Profile** - you can change the x10 bands of the Custom EQ profile so as to make it fit your current needs.
- **x10 bands EQ** - x10 bands EQ, from 32Hz to 16KHz.

## Microphone Tab

From this tab, you can access all of Nahimic 2's microphone effects and settings.

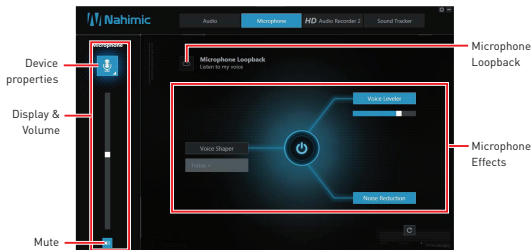

- **Display & Volume** - displays the type of audio recording device currently being used as input, as well as its current volume.
  - **Mute** - mutes the current device.
  - **Device properties** - allows you to boost the volume and modify the left/ right balance of microphone. Clicks on this button and a device properties panel will show.
- **Microphone Loopback** - turns the microphone loopback On/Off. In order to avoid any feedback (Larsen effect).
- **Microphone Effects** - allows you to separately control any of the 3 microphone effects.
  - **Voice Shaper** - applies a filter to the voice.
  - **Voice Leveler** - levels the volume of your voice in order to avoid any saturation and maintains a constant and clear communication. Voice Leveler can be adjusted with a 0 to 100% slider.
  - **Noise Reduction** - removes the remaining sound that the Noise Gate has left on top of your words and sentences.

## HD Audio Recorder 2

From this tab, you can access the audio launchpad and HD Audio Recorder 2 settings.

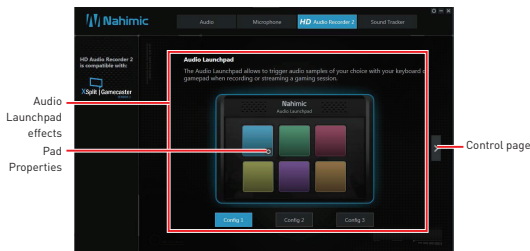

- **Audio Launchpad effects** - allows streamers to use prerecorded sounds during a livestream. These sounds can also be heard by viewers. This tool will allow you to create your true audio identity. That way, your livestreams will be more personal and animated. The Audio Launchpad is one of the fresh new features of Nahimic 2. As it's a feature designed for broadcasters, we included it in the HD Audio Recorder 2 page.
  - **Pad Properties** - every pad can be customized by clicking the properties button that will appear in its bottom right when hovering over it with your mouse. On the Pad Properties panel you can choose:
    - The sound assigned to each pad.
    - The keyboard hotkey assigned to each pad.
    - The color assigned to each pad.
  - **Config 1, 2 & 3** - allows you to prepare 3 completely different configurations so as to adapt the Launchpad to the content you are streaming. Each configuration has 6 customizable pads. The 3 configurations are independent, meaning Config 1 cannot be used at the same time than Config 3.

- **Control Page** - by clicking the arrow button, you can access the control page.

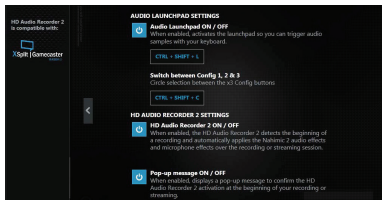

- **Audio Launchpad ON/OFF** - switches the Audio Launchpad on or off.
- **HD Audio Recorder 2** - The HD Audio Recorder 2 is, by default, automatically launched when a XSplit Gamecaster 2 recording session is detected. The launch of the HD Audio Recorder 2 enables HD audio processing over an XSplit Gamecaster 2 recording without any need for adjustments. The HD Audio Recorder supports XSplit Gamecaster 2.
- **Pop-up message ON/OFF** - switches the pop-up message on or off.

## Sound Tracker

The Sound Tracker is an FPS oriented feature that provides a visual indication localizing the source of the strongest sound while in a game. The Sound Tracker captions the 5.1 and 7.1 sound streams processed by your audio system, and is displayed in all applications and games using DirectX 9, 9c, 10 and 11. Please remember Sound Tracker is only available if you are using an audio device that supports Nahimic 2 effects.

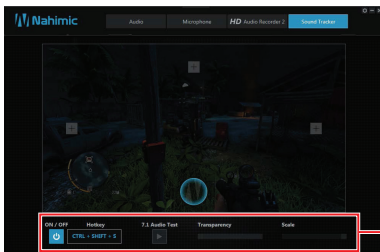

Sound Tracker Effects

- **ON / OFF button and hotkey** - switches the Sound Tracker on or off.
- **Hotkey** - use the CTRL + SHIFT + S to turn ON / OFF the Sound Tracker.
- **7.1 Audio Test** - launch a 7.1 audio sample allowing you to preview how the radar will react in your game.
- **Transparency** - allows you to adjust the transparency of the Sound Tracker, making it look more or less discrete.
- **Scale** - allows you to adjust the scale of the Sound Tracker, making it look bigger or smaller.

## SteelSeries Engine 3

SteelSeries Engine 3 is a unified platform built to support all of SteelSeries products. It can deploy your saved device settings automatically when switching between your favorite games or applications.

After installation the SteelSeries Engine background processes will start and the interface will open automatically.

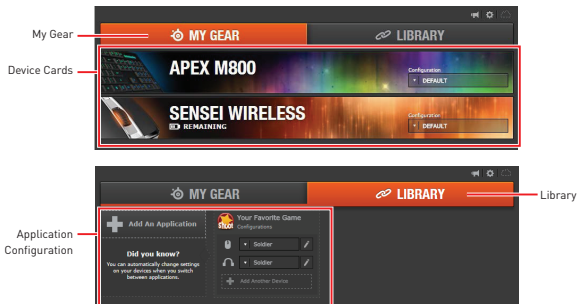

- **My Gear** - all of your SteelSeries devices in one place.
  - **Device Cards** - all of your SteelSeries devices are easily accessible from the My Gear tab, regardless of type, connection status, or which applications they are assigned to.
- **Library** - quickly set up your configurations to autolaunch with an application.
  - **Application Configuration** - you can choose to have configurations deploy automatically whenever you use a specific game or application. Add any number of applications to your library and SteelSeries Engine 3 will seamlessly change the configurations of your devices as you switch between them.

## Configuration Windows

Configuration Windows are unique to their devices and each of them includes a collapsible **Configuration List Panel** of all the configurations for that device. You can create a new configuration by selecting the **New** button at the bottom of the Configuration List Panel.

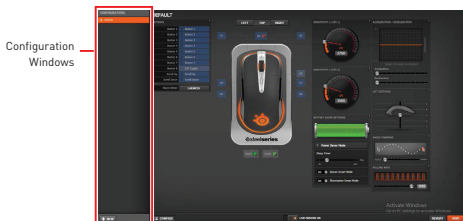

## Configuring Your Devices

You can custom configurations for SteelSeries devices in their Configuration Windows. The top left displays the name of the configuration you are viewing, the body features widgets for customizing various functions of the device, and at the bottom are Save/ Revert buttons, a Live Preview toggle, and a button to open/close the collapsible Configuration List Panel.



- **Widgets** - allow you to customize a certain aspect of your device.
- **Widgets Toggle** - allows you to toggle Widgets .
- **Configuration Windows Toggle** - allows you to toggle the Configuration Windows.
- **Live Preview** - gives you the full experience of your configuration's look, feel, and sound while you are editing it.
- **Revert/ Save Button** - configuration changes are not written to the database until you select **Save**. This gives you freedom to experiment, knowing that you can select **Revert** to undo changes.

### Tool Tip

When you click the question mark next to a feature name on the panel, a tooltip will show, describing the particular function of that item.

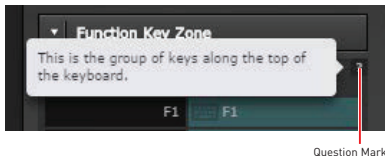

## Intel® Extreme Tuning Utility

Intel® Extreme Tuning Utility (Intel XTU) is a simple overclocking software for you to tune, test and monitor your system.



### • Views Settings Help

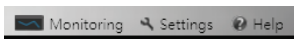

- **Views** - toggles to switch between **Monitoring** and **Show All** view.
- **Settings** - opens the **General Settings** window.
- **Help** - displays the help content for Intel XTU in a separate window.
- **Navigation** - lists all of the major functions of Intel XTU.
  - **System Information** - shows the details about your system.
  - **App-Profile Pairing** - tunes automatically based on active application.
  - **Manual Tuning** - changes system settings in a free form.
  - **Stress Test** - tests the stability of your system.
  - **Benchmarking** - analyzes and compares your system's performance against other system profiles.
  - **Profiles** - manages sets of system settings.
- **Tuning Controls** - displays the controls for changing the system settings in manual tuning. For stress tests and profiles, this area displays the settings for these features.
- **System Table** - displays information about the current system settings and a summary of your changes.
- **System Graphs** - shows measured system values over a period of time. The system graphs update live as changes are detected in the system. You can customize the system graphs to show the data you need for your overclocking strategy in the system graphs preferences.
- **System Monitors** - shows the range of the value, averages, and the current value. The monitors change color if the monitored values fall into warning or critical zones.

## CPU-Z

CPU-Z is an utility that gathers information on some of the main devices of your system.

**CPU-Z** — X

**CPU** Caches Mainboard Memory SPD Graphics Bench About

**Processor**

Name	Intel Core i3/5/7		
Code Name	Skylake-E/EP	Max TDP	140.0 W
Package			
Technology	14 nm	Core Voltage	0.896 V

**Specification**

Genuine Intel® CPU 0000% (ES)					
Family	6	Model	5	Stepping	2
Ext. Family	6	Ext. Model	55	Revision	

**Instructions** MMX, SSE, SSE2, SSE3, SSSE3, SSE4.1, SSE4.2, EM64T, VT-x, AES, AVX, AVX2, FMA3, TSX

**Clocks (Core #0)**

Core Speed	934.6 MHz
Multiplier	x 10.0 (-10 - 32)
Bus Speed	100.0 MHz
Rated FSB	

**Caches**

L1 Data	10 x 32 KBytes	8-way
L1 Inst.	10 x 32 KBytes	8-way
Level 2	10 x 1024 KBytes	16-way
Level 3	14080 KBytes	11-way

Selection: Processor #1    Cores: 10    Threads: 20

Version 1.78.1    Validate    OK

- **CPU Tab** - shows processor name, code name, package, specification, instructions sets, core speed and cache levels.
- **Caches Tab** - shows extended information related to the cache capabilities.
- **Mainboard Tab** - shows motherboard manufacturer, model name, chipset, BIOS version and graphic interface.
- **Memory Tab** - shows memory type, memory size, channels, memory frequency.
- **SPD Tab** - shows specifications relating to each memory module connected to the motherboard, including the size, type and frequency.
- **Graphics Tab** - shows GPU name, code name, core speed, memory size, and memory type.
- **Bench Tab** - allows you to run either a benchmark or a stress test on your processor.
- **About Tab** - shows the CPU-Z version, Windows version, DirectX version and allows you to save the report file.

## TriDef VR

With TriDef VR you can play your favorite PC games on a huge 3D screen inside your virtual reality headset. It is compatible with the Oculus Rift and HTC Vive.

After installation, please ensure that your VR headset is set up and working correctly, then double-click **TriDef VR Games** on the Desktop, or from:

### Start > TriDef > TriDef VR Games

You can now put on your VR headset to experience TriDef VR!

## VR Environment

With the headset on, you'll now find yourself inside a VR environment. Move your head around to change your view of the surroundings. A virtual screen will be visible in front of you. This screen will initially be showing the Windows desktop.



While TriDef VR is running, any Windows application you use will be shown on the virtual screen. Web browsers, games, media players, Windows Store apps, productivity apps, etc. can all be displayed on this 2D screen.

Use your mouse and keyboard as usual to control the applications. Audio will also be sent to your headphones.

## Main Window

The main TriDef VR application window controls various aspects of the VR experience. This window can be minimized if desired, but closing the window will exit TriDef VR. The Help menu provides a link to this user guide, our privacy policy and an about box.

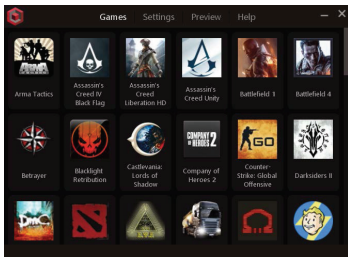

## Games Tab

The first tab you'll see on the main window is the Games tab. As mentioned, apps or games launched from the desktop will appear in 2D on the virtual screen. However, if you launch a supported game from the Games tab, it will be displayed on the virtual screen in stereoscopic 3D!

The first time you launch TriDef VR, the application will scan your PC and automatically add supported games to the list. If a particular game wasn't found, or new games have been installed, then click the Add Game(s) tile:

Games can be removed from the list by right-clicking on the tile and selecting Remove. The Edit option in the right-click menu allows you to modify the game name and other properties.

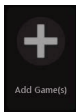

## Settings Tab

The virtual screen's size, distance, curvature and background environment can be modified in the Settings tab.

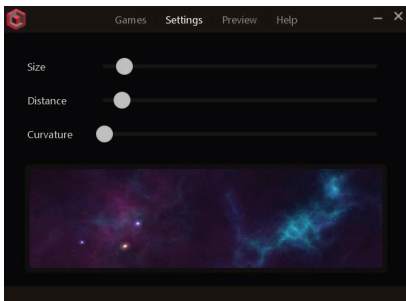

## VR Controls

While in the VR environment, look down below the screen to see the Recenter and Settings items. As you look directly towards those items, a small white dot will appear. Aim this dot directly at an item to highlight it.

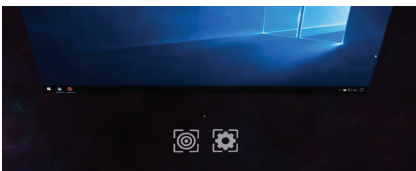

### Recenter



Look at the Recenter item for 1 second to enter recentering mode. Now look in the direction you would like the screen to appear. After a few seconds the screen will move to the new location.

## Settings Popup



Look at the Settings item for 1 second to display the Settings popup. This popup window appears in front of the virtual screen. Use your mouse to adjust the slider values.

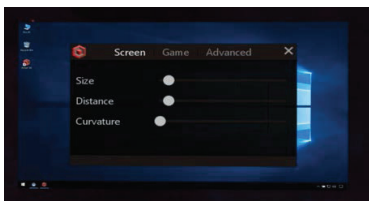

- **Screen Settings** - adjust the virtual screen's size, distance and curvature.
- **Game Settings** - adjust 3D settings for that game. Please note that these settings are not available for applications and games launched from the desktop as those are displayed in 2D only.
- **Advanced Settings** - adjust the audio volume, game FPS and output quality. The **Audio** setting is only available when TriDef VR is redirecting the audio from a different output, so if the slider is disabled, then use the normal Windows volume controls instead. The **Game FPS** setting is provided for troubleshooting purposes only. The **Default** value should produce the best results. However, if a game appears to be stuttering on the virtual screen, then other options may fix this. **Output quality** determines how TriDef VR displays images on the virtual screen. The **Best** quality setting produces smoother images with more readable text characters. This is achieved by supersampling, which requires additional GPU resources. The **Better** option reduces the size of the supersampling process while Good renders the image without using supersampling.

## TriDef SmartCam

Use TriDef SmartCam to replace or SmartBlur your background in video chat applications or to remove your background in XSplit.

Just select TriDef SmartCam wherever you see a list of cameras or choose your webcam application. The following description uses XSplit Gamecaster for an example.

### TriDef SmartCam for XSplit Gamecaster

After installation TriDef SmartCam is integrated into XSplit Gamecaster version 2.5 and newer.

To enable TriDef SmartCam, launch Gamecaster as usual, and select the **Settings** tab.

Click the **BACKGROUND** option below the camera preview, then select **TriDef SmartCam** from the list.

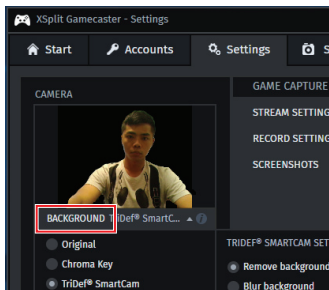

You'll now see yourself in front of a black background. When you switch to your game, the black area will be transparent, so the game itself will be visible instead of your background!

### Options

When TriDef SmartCam is selected, several advanced settings are also made available.

TriDef SmartCam's background replacement can operate in one of two modes. In **Normal** mode, SmartCam will detect you and any movement in the background. Other people moving in the background will be included, as will your arms and other objects that are in motion. This may not be desirable in some circumstances, particularly in public settings.

For those occasions, **Head & Shoulders Only** mode would be more suitable. In this mode only you will be visible, specifically your face and upper torso. Arms usually won't be visible in this mode, and neither will objects or people behind you. Tick the Head & Shoulders Only checkbox to select this mode.

The **Quality** setting allows you to trade off image quality for processing speed. A higher quality setting will result in more accurate foreground detection, but requires more processing. This results in higher CPU usage which can reduce your game's frame rate.

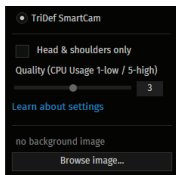

# RAID Configuration

Below are the different types of a RAID.

- RAID 0** breaks the data into blocks which are written to separate hard drives. Spreading the hard drive I/O load across independent channels greatly improves I/O performance.
- RAID 1** provides data redundancy by mirroring data between the hard drives and provides enhanced read performance.
- RAID 5** provides data striping at the byte level and also stripe error correction information. This results in excellent performance and good fault tolerance.
- RAID 10** uses four hard drives to create a combination of RAID 0 and 1 by forming a RAID 0 array from two RAID 1 arrays.

## RAID level comparison

	RAID 0	RAID 1	RAID 5	RAID 10
Minimum # drives	2	2	3	4
Data protection	None	Excellent	Excellent	Excellent
Read performance	Excellent	OK	Good	OK
Write performance	Excellent	Good	OK	Good
Capacity utilization	100%	50%	67%~(1-1/n)	50%

## Using Intel® Rapid Storage Technology Option ROM

First, you need to set the **SATA mode** to **RAID** in BIOS to create, delete and reset RAID volumes. To enter the IRST Option ROM, reboot and press **Ctrl + I** keys to enter the IRST Option ROM during the POST, the following window will appear.

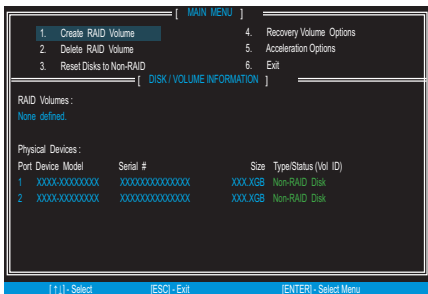

### Important

The following procedure is only available with a newly-built system or if you are reinstalling your OS. It should not be used to migrate an existing system to RAID.

## Creating s RAID Volume

1. Select option **Create RAID Volume** and press **Enter** key. The following screen appears.

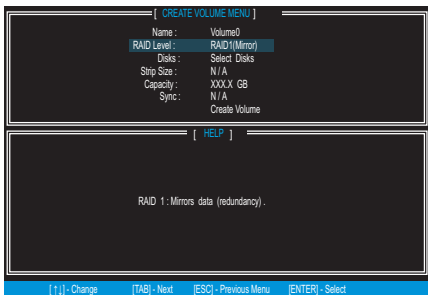

2. Specify a RAID Volume name and then press the **Tab** or **Enter** key to go to the next field
3. Use the **↑ ↓ ← →** arrow keys to select the RAID level best suited to your usage model in RAID Level.
4. In the Disk field, press **Enter** key and use **Space** key to select the disks you want to create for the RAID volume, then click **Enter** key to finish selection. This field will become available according to the selected RAID level.
5. Select the strip size for the RAID array by using the **↑ upper arrow** or **↓ down arrow** keys to scroll through the available values, and pressing the **Enter** key to select and advance to the next field. The available values range from 4KB to 128 KB in power of 2 increments. The strip size should be chosen based on the planned drive usage. Here are some typical values:  
RAID0 - 128KB / RAID10 - 64KB / RAID5 - 64KB.
6. Select the capacity of the volume in the **Capacity** field. The default value is the maximum volume capacity of the selected disks.

### **Important**

Since you want to create two volumes, this default size (maximum) needs to be reduced. Type in a new size for the first volume. As an example: if you want the first volume to span the first half of the two disks, re-type the size to be half of what is shown by default. The second volume, when created, will automatically span the remainder of two hard drives.

7. Go to the **Create Volume** field and press **Enter**, a WARNING message will appear for you to confirm if you are sure to create the RAID volume. Press **Y** to continue.

## Removing a RAID Volume

Here you can delete the RAID volume, but please be noted that all data on RAID drives will be lost.

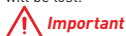

### Important

*If your system currently boots to RAID and you delete the RAID volume in the IRST Option ROM, your system will become unbootable.*

Select option **Delete RAID Volume** from the main menu screen and press **Enter** key to select a RAID volume for deletion. Then press **Delete** key to delete the selected RAID volume. The following screen appears.



Press **Y** key to accept the volume deletion.

## Resetting Disks to Non-RAID

Select option **Reset Disks to Non-RAID** from the main menu screen and press **Enter** to delete the RAID volume and remove any RAID structures from the drives. Use the **Space** key to select the disks and press **Enter** key. A confirmation sentence will appear below, and then press **Y** key to accept the selection

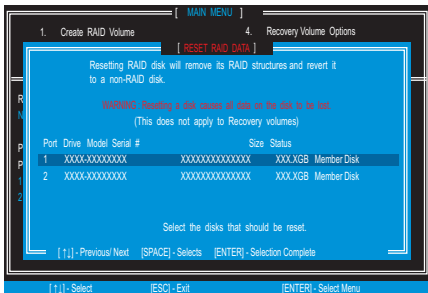

## Important

- You will lose all data on the RAID drives and any internal RAID structures when you perform this operation.
- Possible reasons to **Reset Disks to Non-RAID** could include issues such as incompatible RAID configurations or a failed volume or failed disk.

## Recovery Volume Options

Select option **Recovery Volume Options** from the main menu screen and press **Enter** to change recovery volume mode. The following screen appears:

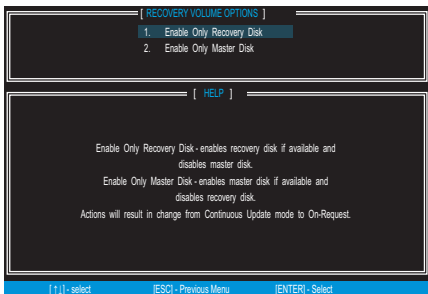

Recovery mode will change from Continuous Update to On-Request after you enable **Only Recovery Disk** or **Only Master Disk**.

## Degraded RAID Array

A RAID 1, RAID 5 or RAID 10 volume is reported as degraded when one of its hard drive members fails or is temporarily disconnected, and data mirroring is lost. As a result, the system can only utilize the remaining functional hard drive member. To re-establish data mirroring and restore data redundancy, refer to the procedure below that corresponds to the current situation.

RAID Volumes						
ID	Name	Level	Strip	Size	Status	Bootable
0	Volume0	RAID 1(Mirror)	N/A	XXX.XGB	Degraded	Yes

Physical Disks:				
Port	Device Model	Serial #	Size	Type/Status(Vol ID)
1	XXXXXXXXXXXXXX	XXXXXXXXXXXXXX	XXX.XGB	Member Disk (0)
2	XXXXXXXXXXXXXX	XXXXXXXXXXXXXX	XXX.XGB	Member Disk (0)

Press <CTRL-I> to enter Configuration Utility..

## Missing Hard Drive Member

1. Power off.

2. Reconnect the hard drive.
3. Reboot to Windows®; the rebuild will occur automatically.

## Failed Hard Drive Member

1. Power off.
2. Replace the failed hard drive with a new one that is of equal or greater capacity.
3. Reboot the system to IRST Option ROM by press **Ctrl + I** keys during the POST.
4. Select the port of the destination disk for rebuilding, and then press **Enter**.

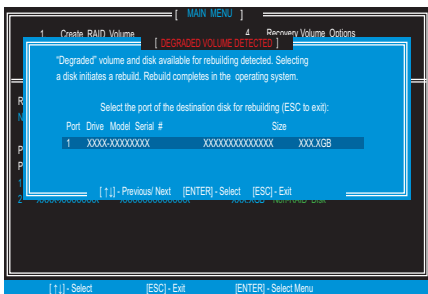

5. Exit IRST Option ROM, reboot to Windows®.
6. When prompted to rebuild the RAID volume, click **Yes**.
7. The **Intel® Rapid Storage Technology** application will be launched. Right-click the new hard drive and select **Rebuild to this Disk**. The **Rebuild Wizard** will be launched which will guide you through the process of rebuilding to the new hard drive.

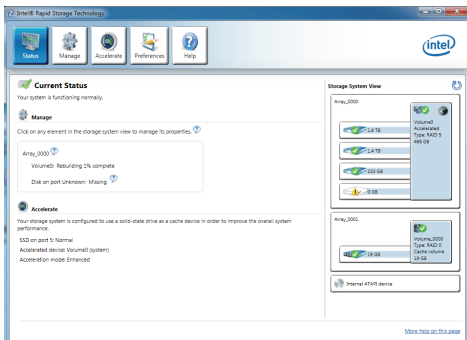

# Intel® Optane™ Memory Configuration

Intel® Optane™ memory can accelerate the Windows 10 64bit operating system. This section describes how to install and remove the Intel® Optane™ memory.

## System Requirements

- Intel® Optane™ memory ready MSI® motherboards
- Supported 7th Gen, or later, Intel® Core™ - i Processor
- System BIOS that supports the Intel® Rapid Storage Technology (Intel® RST) 15.5 or later driver
- Operating system: Windows 10 64 bit [UEFI mode].
- Intel® Optane™ Memory Module

## Installing the Intel® Optane™ memory

The Intel® Optane™ memory is pre-installed on this motherboard, just skip to step 4: Install the Intel® Rapid Storage Technology 15.5.

1. Update BIOS (refer to the **Updating BIOS** section).
2. Install the Intel® Optane™ memory module.
  - Power off the system.
  - Refer to the **Specifications** for location to install your Intel® Optane™ memory module.
  - Install the Intel® Optane™ memory module into the M.2 slot.
3. Enable M.2/Optane Genie
  - Power on and press **Delete** key to enter BIOS Setup menu.
  - Enable M.2/Optane Genie by clicking the **M.2/Optane Genie** item.
  - Click **Ok** in the dialog.
  - Press **F10** to save configuration and exit.
4. Install the Intel® Rapid Storage Technology 15.5
  - Reboot to operating system.
  - Install the Intel® Rapid Storage Technology 15.5
  - Reboot System.

5. Enable Intel® Optane™ Memory.

- Enable Intel® Optane™ Memory via the Intel® Optane™ memory application (auto-launches upon reboot).
- Click **Yes** in the dialog.

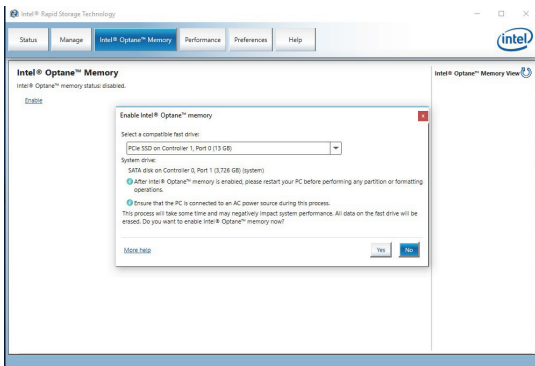

- Reboot System.



**WARNING**

Once you enable Intel® Optane™ memory, in order to prevent seriously damage your operating system, please follow the cautions listed below.

- **DO NOT set the SATA mode back to AHCI in BIOS.**
- **DO NOT revert back to older version of the BIOS.**
- **DO NOT remove the Intel® Optane™ memory module.**
- **DO NOT replace the CPU that is not supported by Intel® Optane™ Memory.**

## Removing the Intel® Optane™ memory

If you no longer want to use Intel® Optane™ memory, you have to disable the Intel® Optane™ memory before removing the Intel® Optane™ memory module to avoid operating system damage. Please follow the steps below to remove the Intel® Optane™ memory.

1. Disable Intel® Optane™ Memory.
  - Disable Intel® Optane™ Memory via the Intel® Optane™ memory application (Intel® Rapid Storage Technology).
  - Click **Yes** in the dialog.

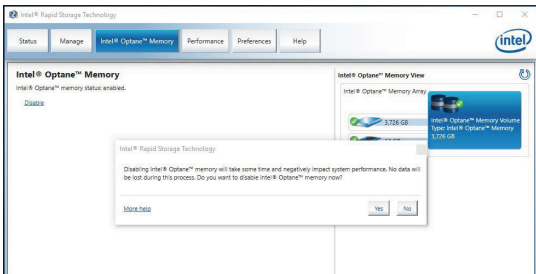

- Reboot System.
2. Disable M.2/Optane Genie
  - Press **Delete** key to enter BIOS Setup menu during POST.
  - Disable M.2/Optane Genie by clicking **M.2/Optane Genie** item.
  - Click **Ok** in the dialog.
  - Press **F10** to save configuration and exit.
3. Remove the Intel® Optane™ memory module.
  - Power off the system.
  - Remove the Intel® Optane™ memory module.

## Troubleshooting

When you installed the operating system in AHCI mode, the system will be changed to RAID/ Optane mode after enabling Intel® Optane™ Memory. If you want to disable Intel Optane Memory and switch BIOS setting from RAID/ Optane mode back to AHCI mode, that may cause operating system damage. MSI has developed a software assistance for this problem. You can disable Intel® Optane™ Memory and switch back to AHCI mode while keep the system bootable with MSI SMART TOOL.

Please follow the steps below to disable Intel® Optane™ Memory and set the SATA mode back to AHCI.

1. Run MSI SMART TOOL.



2. Click the **OPTANE** icon. (Note: the OPTANE icon is only available when Intel® Optane™ Memory has been enabled)
3. Click **Yes**.

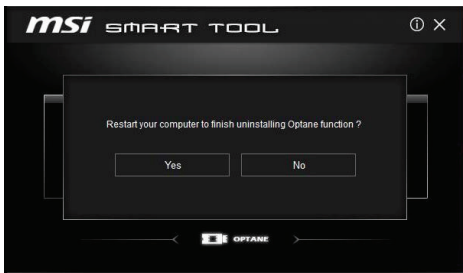

4. Reboot System.

# Troubleshooting

Before sending the motherboard for RMA repair, try to go over troubleshooting guide first to see if you got similar symptoms as mentioned below.

## The power is not on.

- Connect the AC power cord to an electrical outlet securely.
- Check if all ATX power connectors like **ATX\_PWR1**, **CPU\_PWR1** are connected from the power supply to the motherboard?
- Some power supply units have a power button on the rear side, make sure the button is turned on.
- Check if the power switch cable is connected to **JFP1** pin header properly.
- Verify the **Clear CMOS** jumper **JBAT1** is set to **Keep DATA**.
- Test with another known working power supply of equal or greater wattage.

## The power is on, but no signal to monitor

- Connect the monitor power cord to a electrical outlet securely.
- Make sure the monitor is turned on.
- Select different inputs on the monitor.
- If 3 long beeps are heard, remove all memory modules and try to install only one memory module in the **DIMMA1** slot first and then restart the computer.
- If 1 long 2 short beeps are heard, remove and reinstall the graphics card and then restart the computer.
- Test with another known working graphics card.

## The computer does not boot after updating the BIOS

- Clear the CMOS.
- Use the secondary BIOS to bootup the system (Only for motherboard with Dual BIOS)

## Lost BIOS password

- Clear the CMOS, but that will cause you to lose all customized settings in the BIOS.

## There is no audio

- Adjust the volume.
- Connect the speakers/headphones to audio ports on the motherboard rear IO panel.
- Remove secondary speakers/headphones, HDMI cables, USB audio devices.
- Test with another known working speaker or headphone.

## There is no network

- Make sure the network chipset driver has been installed.
- Verify if the network cable is properly connected and make sure the LAN port LEDs are properly illuminated.
- Verify your TCP/IP settings.
- Restart or reset your router.
- Test with another known working LAN cable.

## The USB device is not working

- Make sure your USB drive driver has been installed.
- Verify if USB device is listed in Windows® Device Manager.
- Connect the USB device to other USB port on the motherboard rear IO panel.

# Regulatory Notices

## FCC Compliance Statement

Note: This equipment has been tested and found to comply with the limits for a Class B digital device, pursuant to part 15 of the FCC Rules. These limits are designed to provide reasonable protection against harmful interference in a residential installation. This equipment generates, uses and can radiate radio frequency energy and, if not installed and used in accordance with the instructions, may cause harmful interference to radio communications. However, there is no guarantee that interference will not occur in a particular installation. If this equipment does cause harmful interference to radio or television reception, which can be determined by turning the equipment off and on, the user is encouraged to try to correct the interference by one or more of the following measures:

- Reorient or relocate the receiving antenna.
- Increase the separation between the equipment and receiver.
- Connect the equipment into an outlet on a circuit different from that to which the receiver is connected.
- Consult the dealer or an experienced radio/TV technician for help.

Caution: Changes or modifications not expressly approved by the party responsible for compliance could void the user's authority to operate the equipment.

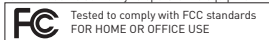

This device complies with part 15 of the FCC Rules. Operation is subject to the following two conditions:  
(1) This device may not cause harmful interference, and  
(2) This device must accept any interference received, including interference that may cause undesired operation.

## CE Conformity



Products bearing the CE marking comply with one or more of the following EU Directives as may be applicable:

RED 2014/53/EU; Low Voltage Directive 2014/35/EU; EMC Directive 2014/30/EU; RoHS Directive 2011/65/EU. Compliance with these directives is assessed using applicable European Harmonized Standards. The point of contact for regulatory matters is MSI, MSI-NL Eindhoven 5706 5692 ER Son.

## B급 기기 (가정용 방송통신기자재)



이 기기는 가정용(B급) 전자파적합기로서 주로 가정에서 사용하는 것을 목적으로 하며, 모든 지역에서 사용할 수 있습니다.

## クラスB情報技術装置



この装置は、クラスB情報技術装置です。この装置は、家庭環境で使用することを目的としていますが、この装置がラジオやテレビジョン受信機に近接して使用されると、受信障害を引き起こすことがあります。取扱説明書に従って正しい取り扱いをして下さい。

VCCI-B

## C-Tick Compliance



N1996

## Battery Information

European Union:



Batteries, battery packs, and accumulators should not be disposed of as unsorted household waste. Please use the public collection system to return, recycle, or treat them in compliance with the local regulations.

Taiwan:



廢電池請回收

For better environmental protection, waste batteries should be collected separately for recycling or special disposal.

California, USA:



The button cell battery may contain perchlorate material and requires special handling when recycled or disposed of in California.

For further information please visit:

<http://www.dtsc.ca.gov/hazardouswaste/perchlorate/>

CAUTION: There is a risk of explosion, if battery is incorrectly replaced.

Replace only with the same or equivalent type recommended by the manufacturer.

## Chemical Substances Information

In compliance with chemical substances regulations, such as the EU REACH Regulation [Regulation EC No. 1907/2006 of the European Parliament and the Council], MSI provides the information of chemical substances in products at:  
[http://www.msi.com/html/popup/csr/evmtprrt\\_pcm.html](http://www.msi.com/html/popup/csr/evmtprrt_pcm.html)

## Environmental Policy

- The product has been designed to enable proper reuse of parts and recycling and should not be thrown away at its end of life.
- Users should contact the local authorized point of collection for recycling and disposing of their end-of-life products.
- Visit the MSI website and locate a nearby distributor for further recycling information.
- Users may also reach us at [gpcontdev@msi.com](mailto:gpcontdev@msi.com) for information regarding proper Disposal, Take-back, Recycling, and Disassembly of MSI products.



## WEEE (Waste Electrical and Electronic Equipment) Statement

ENGLISH

To protect the global environment and as an environmentalist, MSI must remind you that...

Under the European Union ("EU") Directive on Waste Electrical and Electronic Equipment, Directive 2002/96/EC, which takes effect on August 13, 2005, products of "electrical and electronic equipment" cannot



be discarded as municipal wastes anymore, and manufacturers of covered electronic equipment will be obligated to take back such products at the end of their useful life. MSI will comply with the product take back requirements at the end of life of MSI-branded products that are sold into the EU. You can return these products to local collection points.

#### DEUTSCH

Hinweis von MSI zur Erhaltung und Schutz unserer Umwelt  
Gemäß der Richtlinie 2002/96/EG über Elektro- und Elektronik-Altgeräte dürfen Elektro- und Elektronik-Altgeräte nicht mehr als kommunale Abfälle entsorgt werden. MSI hat europaweit verschiedene Sammel- und Recyclingunternehmen beauftragt, die in die Europäische Union in Verkehr gebrachten Produkte, am Ende seines Lebenszyklus zurückzunehmen. Bitte entsorgen Sie dieses Produkt zum gegebenen Zeitpunkt ausschließlich an einer lokalen Altgerätesammelstelle in Ihrer Nähe.

#### FRANCAIS

En tant qu'écologiste et afin de protéger l'environnement, MSI tient à rappeler ceci...  
Au sujet de la directive européenne (EU) relative aux déchets des équipements électriques et électroniques, directive 2002/96/EC, prenant effet le 13 août 2005, que les produits électriques et électroniques ne peuvent être déposés dans les décharges ou tout simplement mis à la poubelle. Les fabricants de ces équipements seront obligés de récupérer certains produits en fin de vie. MSI prendra en compte cette exigence relative au retour des produits en fin de vie au sein de la communauté européenne. Par conséquent vous pouvez retourner localement ces matériels dans les points de collecte.

#### РУССКИЙ

Компания MSI предпринимает активные действия по защите окружающей среды, поэтому напоминаем вам, что...  
В соответствии с директивой Европейского Союза (ЕС) по предотвращению загрязнения окружающей среды использованным электрическим и электронным оборудованием [директива WEEE 2002/96/EC], вступающей в силу 13 августа 2005 года, изделия, относящиеся к электрическому и электронному оборудованию, не могут рассматриваться как бытовой мусор, поэтому производители вышеперечисленного электронного оборудования обязаны принимать его для переработки по окончании срока службы. MSI обязуется соблюдать требования по приему продукции, проданной под маркой MSI на территории ЕС, в переработку по окончании срока службы. Вы можете вернуть эти изделия в специализированные пункты приема.

#### ESPAÑOL

MSI como empresa comprometida con la protección del medio ambiente, recomendamos:  
Bajo la directiva 2002/96/EC de la Unión Europea en materia de desechos y/o equipos electrónicos, con fecha de rigor desde el 13 de agosto de 2005, los productos clasificados como "eléctricos y equipos electrónicos" no pueden ser depositados en los contenedores habituales de su municipio, los fabricantes de equipos electrónicos, están obligados a hacerse cargo de dichos productos al término de su período de vida. MSI estará comprometido con los términos de recogida de sus productos vendidos en

la Unión Europea al final de su período de vida. Usted debe depositar estos productos en el punto limpio establecido por el ayuntamiento de su localidad o entregar a una empresa autorizada para la recogida de estos residuos.

#### NEDERLANDS

Om het milieu te beschermen, wil MSI u eraan herinneren dat...  
De richtlijn van de Europese Unie (EU) met betrekking tot Vervuiling van Elektrische en Elektronische producten [2002/96/EC], die op 13 Augustus 2005 in zal gaan kunnen niet meer beschouwd worden als vervuiling. Fabrikanten van dit soort producten worden verplicht om producten retour te nemen aan het eind van hun levenscyclus. MSI zal overeenkomstig de richtlijn handelen voor de producten die de merknaam MSI dragen en verkocht zijn in de EU. Deze goederen kunnen getourneerd worden op lokale inzamelingspunten.

#### SRPSKI

Da bi zaštitili prirodnu sredinu, i kao proizvođač koje vodi računa o okolini i prirodnoj sredini, MSI mora da vas podesti da...  
Po Direktivi Evropske unije ("EU") o odbačenoj elektonskoj i električnoj opremi, Direktiva 2002/96/EC, koja stupa na snagu od 13. Avgusta 2005, proizvodi koji spadaju pod "elektronsku i električnu opremu" ne mogu više biti odbačeni kao običan otpad i proizvođači ove opreme biće prinuđeni da uzmu natrag ove proizvode na kraju njihovog uobičajenog veka trajanja. MSI će poštovati zahtev o preuzimanju ovakvih proizvoda kojima je istekao vek trajanja, koji imaju MSI oznaku i koji su prodati u EU. Ove proizvode možete vratiti na lokalnim mestima za prikupljanje.

#### POLSKI

Aby chronić nasze środowisko naturalne oraz jako firma dbająca o ekologię, MSI przypomina, że...  
Zgodnie z Dyrektywą Unii Europejskiej ("UE") dotyczącą odpadów produktów elektrycznych i elektronicznych [Dyrektywa 2002/96/EC], która wchodzi w życie 13 sierpnia 2005, tzw. "produkty oraz wyposażenie elektryczne i elektroniczne" nie mogą być traktowane jako śmieci komunalne, tak więc producenci tych produktów będą zobowiązani do odbierania ich w momencie gdy produkt jest wycofywany z użycia. MSI wypełni wymagania UE, przyjmując produkty [sprzedawane na terenie Unii Europejskiej] wycofywane z użycia. Produkty MSI będzie można zwracać w wyznaczonych punktach zbiorczych.

#### TÜRKÇE

Çevreci özelliğiyle bilinen MSI dünyada çevreyi korumak için hatırlatır:  
Avrupa Birliği (AB) Kararnamesi Elektrik ve Elektronik Malzeme Atığı, 2002/96/EC Kararnamesi altında 13 Ağustos 2005 tarihinden itibaren geçerli olmak üzere, elektrikli ve elektronik malzemeler diğer atıklar gibi çöpe atılmayacak ve bu elektronik cihazların üreticileri, cihazların kullanım süreleri bittikten sonra ürünleri geri toplamakla yükümlü olacaktır. Avrupa Birliği'ne satılan MSI markalı ürünlerin kullanım süreleri bittiğinde MSI ürünlerin geri alınması isteği ile işbirliği içerisinde olacaktır. Ürünlerinizi yerel toplama noktalarına bırakabilirsiniz.

#### ČESKY

Záleží nám na ochraně životního prostředí - společnost MSI upozorňuje...  
Podle směrnice Evropské unie ("EU") o likvidaci elektrických a elektronických výrobků 2002/96/

EC platné od 13. srpna 2005 je zakázáno likvidovat "elektrické a elektronické výrobky" v běžném komunálním odpadu a výrobci elektronických výrobků, na které se tato směrnice vztahuje, budou povinni odebrat takové výrobky zpět po skončení jejich životnosti. Společnost MSI splní požadavky na odebrání výrobků značky MSI, prodávaných v zemích EU, po skončení jejich životnosti. Tyto výrobky můžete odevzdat v místních sběrnách.

#### MAGYAR

Annak érdekében, hogy környezetünket megvédjük, illetve környezetvédekméket fellépve az MSI emlékezteti Önt, hogy ...  
Az Európai Unió („EU”) 2005. augusztus 13-án hatályba lépett, az elektromos és elektronikus berendezések hulladékaikról szóló 2002/96/EC irányelvet szerint az elektromos és elektronikus berendezések többé nem kezelhetők lakossági hulladékként, és az ilyen elektronikus berendezések gyártói kötelesek válnak az ilyen termékek visszavételére azok hasznos élettartama végén. Az MSI betartja a termékvisszavételrel kapcsolatos követelményeket az MSI márkánév alatt az EU-n belül értékesített termékek esetében, azok élettartamának végén. Az ilyen termékeket a legközelebbi gyűjtőhelyre viheti.

#### ITALIANO

Per proteggere l'ambiente, MSI, da sempre amica della natura, ti ricorda che....  
In base alla Direttiva dell'Unione Europea [EU] sullo Smaltimento dei Materiali Elettrici ed Elettronici, Direttiva 2002/96/EC in vigore dal 13 Agosto 2005, prodotti appartenenti alla categoria dei Materiali Elettrici ed Elettronici non possono più essere eliminati come rifiuti municipali: i produttori di detti materiali saranno obbligati a ritirare ogni prodotto alla fine del suo ciclo di vita. MSI si addeguerà a tale Direttiva ritirando tutti i prodotti marchiati MSI che sono stati venduti all'interno dell'Unione Europea alla fine del loro ciclo di vita. È possibile portare i prodotti nel più vicino punto di raccolta

## 日本JIS C 0950材質宣言

日本工業規格JIS C 0950により、2006年7月1日以降に販売される特定分野の電気および電子機器について、製造者による含有物質の表示が義務付けられます。  
[http://www.msi.com/html/popup/csr/cemmm\\_jp.html](http://www.msi.com/html/popup/csr/cemmm_jp.html)  
[http://tw.msi.com/html/popup/csr\\_tw/cemmm\\_jp.html](http://tw.msi.com/html/popup/csr_tw/cemmm_jp.html)

## India RoHS

This product complies with the "India E-waste (Management and Handling) Rule 2011" and prohibits use of lead, mercury, hexavalent chromium, polybrominated biphenyls or polybrominated diphenyl ethers in concentrations exceeding 0.1 weight % and 0.01 weight % for cadmium, except for the exemptions set in Schedule 2 of the Rule.

## Türkiye EEE yönetmeliği

Türkiye Cumhuriyeti: EEE Yönetmeliğine Uygundur

## Україна обмеження на наявність небезпечних речовин

Обладнання відповідає вимогам Технічного регламенту щодо обмеження використання деяких небезпечних речовин в електричному та електронному обладнанні, затвердженого постановою Кабінету Міністрів України від 3 грудня 2008 № 1057.

## Việt Nam RoHS

Kể từ ngày 01/12/2012, tất cả các sản phẩm do công ty MSI sản xuất tuân thủ Thông tư số 30/2011/TT-BCT quy định tạm thời về giới hạn hàm lượng cho phép của một số hóa chất độc hại có trong các sản phẩm điện, điện tử

## Wireless Radio Use

This device is restricted to indoor use when operating in the 2.4GHz, 5GHz frequency band.

Cet appareil doit être utilisé à l'intérieur.

당해 무선설비는 운용중 전파혼신 가능성이 있음.

この製品は、周波数帯域 2.4GHz, 5GHz で動作しているときは、屋内においてのみ使用可能です。

### NCC無線設備警告聲明

工作頻率2.4GHz, 5GHz該頻段限於室內使用。  
經型式認證合格之低功率射頻電機，非經許可，公司、商號或使用者均不得擅自變更頻率、加大功率或變更原設計之特性及功能。  
低功率射頻電機之使用不得影響飛航安全及干擾合法通信；經發現有干擾現象時，應立即停用，並改善至無干擾時方得繼續使用。前項合法通信，指依電信法規定作業之無線電通信。低功率射頻電機須忍受合法通信或工業、科學及醫療用電波輻射性電機設備之干擾。

### Products with radio functionality (EMF)

This product incorporates a radio transmitting and receiving device. For computers in normal use, a separation distance of 20 cm ensures that radio frequency exposure levels comply with EU requirements. Products designed to be operated at closer proximities, such as tablet computers, comply with applicable EU requirements in typical operating positions. Products can be operated without maintaining a separation distance unless otherwise indicated in instructions specific to the product.

### Restrictions for products with radio functionality



CAUTION: IEEE 802.11x wireless LAN with 5.15–5.35 GHz frequency band is restricted for indoor use only in all European Union member states, EFTA (Iceland, Norway, Liechtenstein), and most other European countries (e.g., Switzerland, Turkey, Republic of Serbia). Using this WLAN application outdoors might lead to interference issues with existing radio services.

### Radio frequency bands and maximum power levels

Features	:802.11 a/b/g/n/ac, BT
Frequency Range	:2.4GHz, 5GHz
Modulation	:FHSS, DSSS, OFDM
Power Output	:10, 20, 23
Channel Band Width	:1, 5, 20, 40, 80MHz

## 产品中有害物质的名称及含量

部件名称	有害物质					
	铅 [Pb]	汞 [Hg]	镉 [Cd]	六价铬 [Cr(VI)]	多溴联苯 [PBB]	多溴二苯醚 [PBDE]
印刷电路板组件*	×	○	○	○	○	○
电池** 	×	○	○	○	○	○
外部信号接头	×	○	○	○	○	○
线材	×	○	○	○	○	○

本表格依据 SJ/T 11364 的规定编制。

○：表示该有害物质在该部件所有均质材料中的含量均在 GB/T 26572 规定的限量要求以下。

×：表示该有害物质至少在该部件的某一均质材料中的含量超出 GB/T 26572 规定的限量要求，但所有部件都符合欧盟RoHS要求。

\* 印刷电路板组件：包括印刷电路板及其构成的零部件。

\*\* 电池本体上如有环保使用期限标识，以本体标识为主。

■ 上述有毒有害物质或元素清单会依型号之部件差异而有所增减。

■ 产品部件本体上如有环保使用期限标识，以本体标识为主。

## 限用物質含有情況標示聲明書

單元	限用物質及其化學符號					
	鉛 [Pb]	汞 [Hg]	鎘 [Cd]	六價鉻 [Cr <sup>VI</sup> ]	多溴聯苯 [PBB]	多溴二苯醚 [PBDE]
電路板	○	○	○	○	○	○
電子元件	—	○	○	○	○	○
金屬機構件	—	○	○	○	○	○
塑膠機構件	○	○	○	○	○	○

備考1. “超出0.1 wt %”及“超出0.01 wt %”係指限用物質之百分比含量超出百分比含量基準值。

備考2. “○”係指該項限用物質之百分比含量未超出百分比含量基準值。

備考3. “—”係指該項限用物質為排除項目。

### Copyright

**msi** Micro-Star Int'l Co., Ltd.  
Copyright © 2017 All rights reserved.

The material in this document is the intellectual property of Micro-Star Int'l Co., Ltd. We take every care in the preparation of this document, but no guarantee is given as to the correctness of its contents. Our products are under continual improvement and we reserve the right to make changes without notice.

### Technical Support

If a problem arises with your system and no solution can be obtained from the user guide, please contact your place of purchase or local distributor. Alternatively, please try the following help resources for further guidance.

- Visit the MSI website for technical guide, BIOS updates, driver updates, and other information: <http://www.msi.com>
- Register your product at: <http://register.msi.com>

### Trademark Recognition

All product names used in this manual are the properties of their respective owners and are acknowledged.

### Revision History

Version 1.0, 2017/09, First release.