

Installation Instructions

Water flow system ice cube making machine



Catalogue

Ice Maker Overview	1
Reception and Inspection	1
Ice Maker Exterior Structure and Interface Names	2
Foot Installation and Foot Placement	3
Installation of Water Supply	4
All-in-one Machine Installation Diagram	5
Split Machine Installation Diagram	6
LCD Control Panel Operating Manual	7-14
Routine Precautions	15
Electrical Safety Matters	16
Maintenance	17
Ice Maker Work Steps	17
Fault Self-diagnosis	17
Fault Detection	18
Before Calling for Service	19
Warranty	20
Out-of-service machine treatment	20

Ice Maker Overview

1. Our company's ice maker adopts advanced technology and technique method, and the strict and comprehensive quality inspection ensures the excellent performance.
2. The core component of the ice maker is compressor which adopts the world famous brand, such as Embraco, Secop, Tecumseh. Together with the reasonable configuration of the refrigeration system, makes the performance of the ice maker more reliable and the energy consumption lower.
3. Food grade 304 stainless steel shell, elegant and durable, corrosion resistant, easy to clean.
4. The refrigerating capacity of water-cooling type ice maker is stable, it is not affected by ambient temperature. It can make ice leisurely with enough output in hot summer.
5. Advanced industrial microcomputer control system can make ice making and ice collecting process automatically. It has many kinds of protection functions which makes the ice maker convenient and safe to use.
6. Our company's products have passed ISO9001-2008, CE, RoHS certificates.

Receiving And Checking

Thank you for selecting our company's automatic ice maker. In order to protect your legitimate rights and interests, please pay attention to the following things when receiving and checking the machine:

1. The outer packing of the machine is intact.
2. Machine's model is consistent with your purchased.
3. The appearance of the machine is in good condition.
4. The attached parts are complete.
5. The internal components of the machine are in good condition.



In the process of transportation, due to improper stacking or handling, the lubricating oil in the compressor will flow into the refrigeration pipeline, resulting in a serious lack of oil for the compressor. Once the electricity is switched on, the compressor will be burned in a short time. Therefore, we strongly suggest that after the customer receives our machine, place the machine in the right position for a day, so that the lubricating oil can flow back to the compressor, then install and use the machine.

Ice Maker Exterior Structure and Interface Names

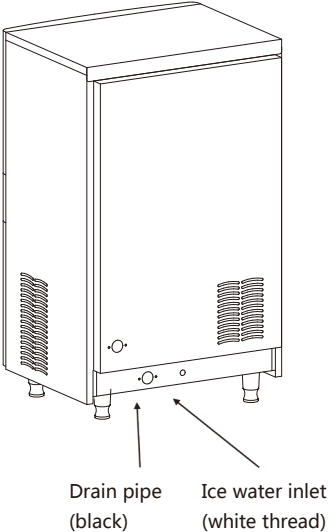
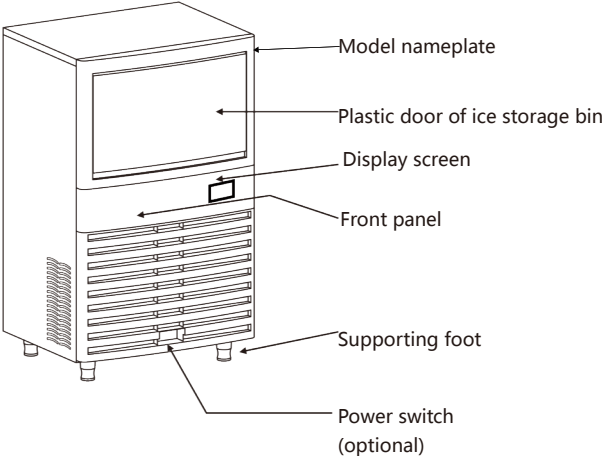

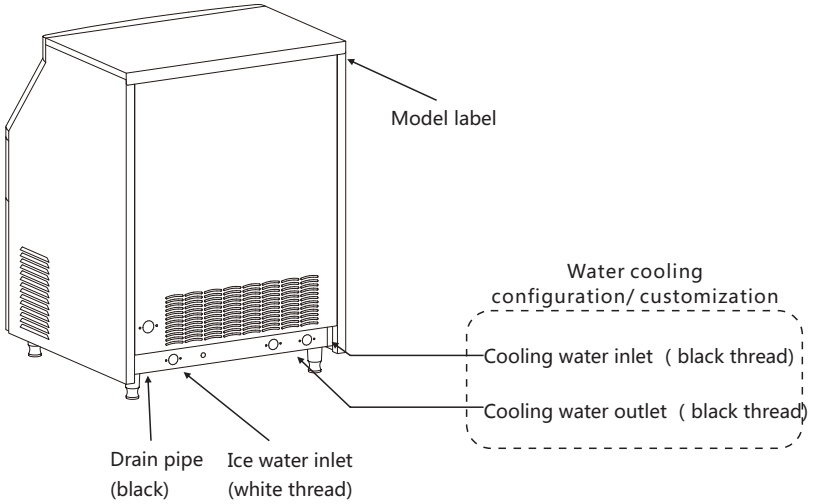

Foot Installation And Foot Placement

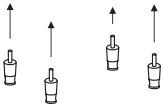
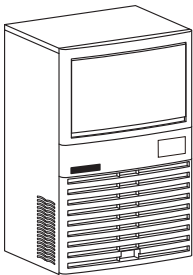

1. Screw the feet of the ice maker to the baseplate.
2. Each foot must be screwed up and tightened so as not to bend.
3. Put the ice maker in a sturdy and flat position.
4. Adjust the height of the foot to make the ice maker level.
5. The ice maker is not suitable for use outdoors. The normal ambient temperature is between 10-38 degrees centigrade, and the water temperature is between 5-30 degrees. Our maximum ice production temperature is: ambient temperature: 21 degrees, water temperature 10 degrees centigrade. High temperature will seriously reduce the amount of ice production. We suggest that the client put the ice maker in a room with cold air.

6. ice making machine should not be installed in the environment without sewer and water seepage, and it is strictly prohibited from high temperature equipment.

7. air-cooled ice making machines (such as refrigerators, ovens, etc.) rely on air circulation to dissipate heat. So it is necessary to keep the space above 15cm to benefit the heat dissipation.

Installation of Water Supply

1.The ice maker must use drinkable normal atmospheric temperature filtered water.

2.Water pressure of water supply must be controlled between 0.3~3MPa, if over pressure pressure reducing valve need to be installed. Don't make the water inlet hose be squeezed.

3.The two ends of the water inlet hose are 3 / 4 " internal thread (20mm) and 1 / 2 " internal thread (15mm) joints with silicone seal washers, so no need to wind tape.

4. The water filter is equipped with a filter element, unscrewing it with a filter wrench before using the water filter. Take out the filter element, tearing up the packaging film of filter element, putting it back as it used to be and screwing up it. Changing the filter element every half year in the process of use.

5.Please notice that the filter cover has the water inlet and the water outlet direction marks.

6.Connecting the joint of 3/4 "with the water inlet of the machine(white 3/4" outer thread), and connect the joint of 1/2 "with water supply pipe.

7.Water-cooled ice maker, added one inlet and one outlet joints of 3/4" external thread pipe, the black color distinguishes them from the water intake of making ice.

8. The ice maker is drained by gravity. Therefore, it is necessary to ensure that the drainage pipe has sufficient slope and drop.

All-in-one Machine Installation Diagram

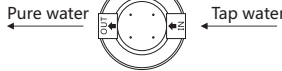
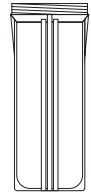
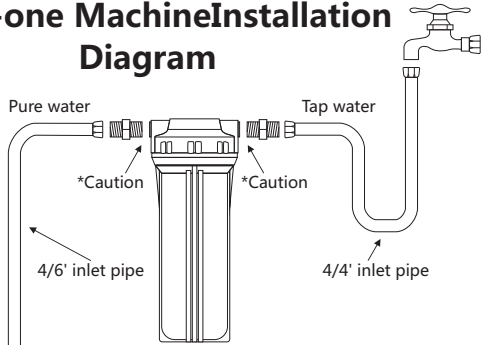
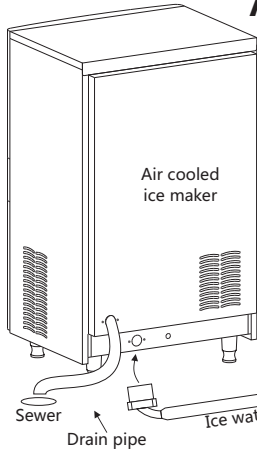

!
Filter core must be taken out before use, tearing off the packaging film and tightening it back

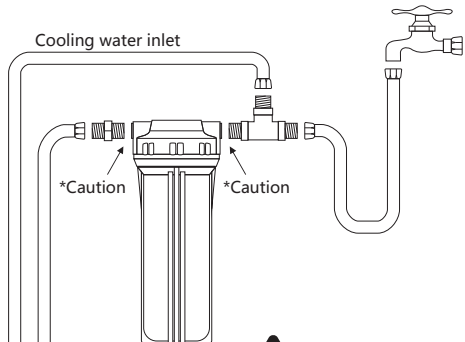
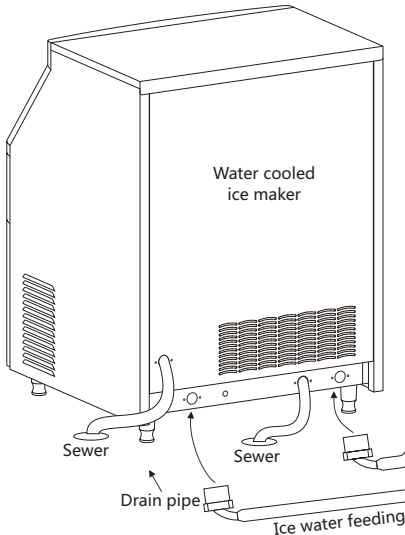

!
The pipe joints on the machine have signs. If there is a conflict, the mark on the machine is the criterion. The white thread interface must be the inlet of the water.

*Caution : Mark swirls interfaces need wrapping tape.

Split Machine Installation Diagram

1. The installation of the split machine should pay attention to the water cooling type more than the condensation into the drainage two joints,

2. The bottom of the ice storage tank has a drain outlet at the bottom. First, the 4/6 outer thread connecting head in the fittings is screwed into the central hole at the bottom of the ice storage bucket, and then connected with the 4/6 hose, and finally exported to the sewer.

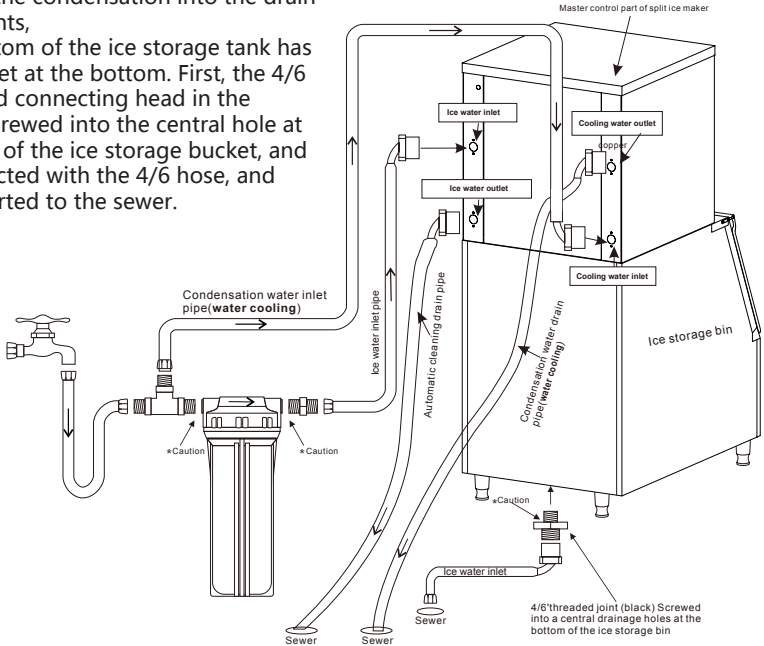

The condenser drain pipe has pressure and cannot be connected with other drains to prevent the case from flowing into the machine and must be inserted into the sewer independently.



The unipolar filter presented by our company can not meet the drinking water standard. Please buy and replace it on your own!

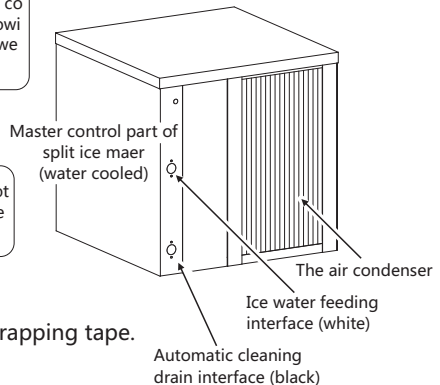

*Caution : Mark swirls interfaces need wrapping tape.

LCDControlPanelOperatingManual

(Available for some models)





General description: This is a fully automatic ice making machine, all programs of the LCD control panel have been set up in the factory. Usually, the user just need to do some simple operation. Please place the machine in the appropriate location and connect to power supplies. (If your machine has red switch on the machine' s back or left side, please turn on it. I=Turn on, O=Turn off) Then the LCD control panel will light up, the machine will run automatically, the user need no any other operation. If you want to stop the machine, just close the red switch.

Note: Unplug the power supplies after finishing the day's work .

I . Button instruction

A. There are five tangibly buttons below the control panel



Pictures	Name	Function
	On/Off button	Turn on/off the machine and set the program
	Model button	Adjust the running model
	Clean/Set button	Clean and set
	Schedule/+ button	Increase the thickness of ice and the duty time.
	Light/- button	Reduce the thickness of ice and duty time,control the light.

B. The exact instruction about the function of the buttons

a. On/Off button

1. Press it to turn off ice machine in the status of power ON .
2. Press it to turn on ice machine in the status of power OFF.
3. Press it to schedule time in the status of time schedule setting.
4. Press it to turn off the machine in the status of time schedule.

b. Clean/Set button

1. Press the button in the status of power OFF , releasing the button when it flashes, machine works on manual clean.
2. Press the button in the status of manual clean, machine go to drain step and then enter into rinsing process after drain finished. Press the button in the status of rinsing, machine will go to drain and then go to next procedure.
3. Press the button goes to manual clean, in the status of ice freezing, ice harvest and ice full .

c. Schedule/+ button

1. Press it to enter time schedule setting when power OFF.
2. In the status of time schedule setting, press the button to increase 10 minutes, long pressing to increase time continuously.
3. In the status of setting, press the button to increase one of the parameter, long pressing to increase continuously.

d. Light/- button

1. In the status of setting, press the button to reduce one of the parameter, long press to reduce continuously.
2. In the status of time schedule setting, press the button to reduce 10 minutes, long press to reduce continuously.
3. In the status of non set , press the button to turn on/off the blue light.

II. LCD control panel status instructions (Drawing instruction)

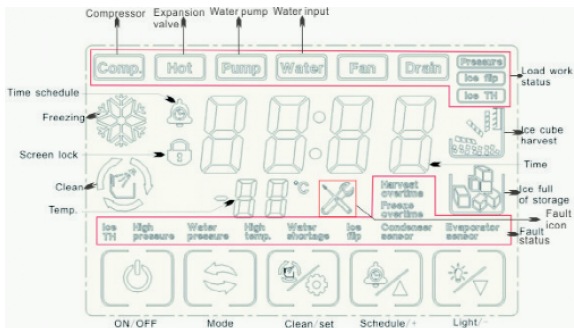

-
1. Switch on: LCD control panel lights up.
 2. Switch on time-delay:
Water inlet: Display time **C00**, icons of **Clean**, **Freezing**, **Ice cube harvest** and **Ice full of storage** light up.
Switch on clean: Display time is cleaning time, **Clean** icon lights up.
Pressure balance: Icons of **Clean**, **Freezing**, **Ice cube harvest** and **Ice full of storage** light up. If condenser sensor had fault, **Fault icon** lights up, **Condenser sensor** icon lights up, temperature displays **EE**.
 3. Manual clean: **Clean** icon flashes. Displays time is cleaning time.(It will not display icon, if the program has no cleaning function..)
 4. Ice freezing: **Freezing**, **Comp.** and regarding icons light up.
Display time is ice freezing time. After entering the countdown program, it displays remaining time for ice making. In the status of delayed shutting down, **Freezing** icon flashes.
If condenser sensor had fault, **Fault icon** light on, **Condenser sensor** icon lights up, temperature displays **EE**.
 5. Ice harvest: **Ice cube harvest** icon light up. Display time is ice cube harvest time. In the status of delayed shutting down, Ice cube harvest icon flashes.
If condenser sensor had fault, Fault icon lights up, Condenser sensor icon lights up, temperature displays **EE**.
 6. Ice full: **Ice full of storage** icon lights up. Display time is ice full time. All the load works will be turned off.

Ice full of storage icon works with ice chute board. When the ice chute board close, **Ice full of storage** icon lights up, **Ice full of storage** icon goes out when ice chute board opens. No button pressed for 60 seconds, screen locked, **screenlock** icon lights up. Press any key to unlock.

Ice full is released (compressor is on delayed status), **Ice full of storage** icon flashes, turn on delay. If condenser sensor had fault, **Fault icon** light on, **Condenser sensor** icon lights up, temperature displays **EE**.

-
7. Fault: **Faulticon** lights up, corresponding fault status icons light on. All the load works will turn off.
 8. Switch off: Displays **OFF**.
 9. Schedule time setting: **Timeschedule** icon lights up. Display time is the schedule time to turn on the machine.
 10. Schedule status: All icons of **Clean, Freezing, Ice cube harvest, Ice full of storage** light up. **Time schedule** icon flashes. Displaying scheduled time counts down.
 11. Condenser fault, **Fault icon** lights up, **Condenser sensor** icon lights up, and the machine working.
 12. Ice chute board or ice full switch faults, **Iceflip** lights up, **Faulticon** flashes.
 13. Overtime ice making fault, if it happens 10 times consecutively, **Freeze overtime** icon lights **Faulticon** flashes.
 14. Overtime ice harvest fault, if it happens 3 times consecutively, **Harvest overtime** icon lights **Faulticon** flashes.
 15. High temperature fault, (condensation temperature is over 65 degree Celsius), **High Temp.** icon lights up and **Faulticon** flashes.
 16. Water shortage fault, after 4 minutes water inputting continuously, water is still not full, **Water shortage** icon lights up and **Faulticon** flashes.
 17. High pressure fault, HP switch open (the function is invalid without HP switch), **High pressure** icon lights up and **Faulticon** flashes.

III. Several frequently-used procedures setting for your reference. Please operate as the following steps when you need.

A. How to adjust the thickness of the ice?

Step 1. When the is on making ice model. Press the discretional one of the five buttons to unlocked.



Step 2. Press Schedule/+ button, the position which displays temperature will flash "00" .



Step 3. Press Schedule/+ button and Light/- button to adjust. Press Schedule/+ button for one time , the position which displays temperature will appear "01" as the following picture. It means the ice making time will be increased 1 min, the ice will become thick.



Press Light/- button for one time , the position which displays temperature will appear "-1" as the following picture. It means the ice making time will be reduced 1 min, the ice will become thin. After setting, you need no other operation, the machine will resume making ice automatically.



B. How to clean the machine?

Step 1. Press the discretionary one of the five buttons to unlocked.

Step 2. Press **On/Off button**, the control panel will appear 'OFF' as the following picture.



Step 3. Press **Clean/Set button**, the control panel will display clean pattern. Usually, 2 minutes to clean the machine is enough.

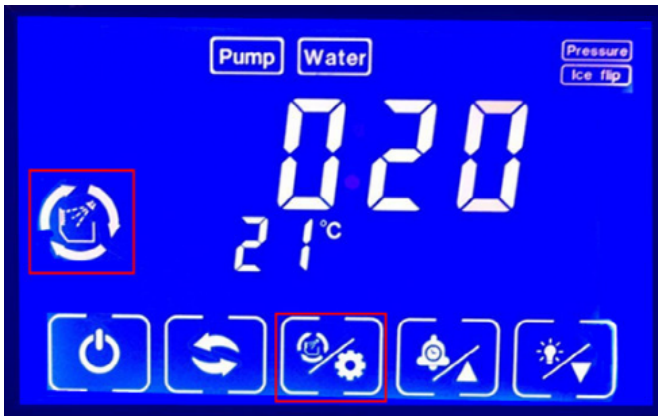

Step 4. Press Model button 3 times to back to making ice model.



C. How to set the program when the ice storage is full?

When the ice storage is full, the control panel will display 'full ice' pattern as the following picture.



Step 1. Use ice shovel to clean the ices which cover on the ice chute board.

Step 2. Press the discretionary one of the five buttons to unlocked.

Step 3. Press **On/Off button** to turn off the machine, the control panel will appear 'OFF'. Step 4. Press **On/Off button** to turn on the machine, then press 3 times **Model button** to back to making ice model.

Routine Cautions

1. When transportation and mobile location, the ice machine tilt shall not exceed 45 degrees.
2. Ice machine, please use independent water source, and check regularly to prevent water pressure is too low, fluctuations or filter clogging.
3. Do not store any sundries in the ice storage room, or freeze any food in the ice storage room and keep the ice shovel clean.
4. Switch the ice storage bucket plastic door, should be light open and light closed, don't beat box door, after taking the ice, please turn off the sliding door of the ice storage bucket.
5. Ice machine should be far away from the heat source. It is strictly prohibited to use in high temperature or low temperature environment. It is necessary to avoid direct sunlight in order to avoid affecting the heat dissipation of the machine.
6. It is forbidden to wash the surface of ice machine directly with water, otherwise it may lead to short circuit, leakage and other faults.
7. After the ice machine is used for a period of time, if it is stopped for a long time, it should be electrified every two months for four to six hours.

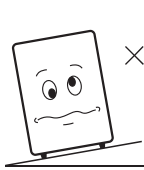

Place smoothly

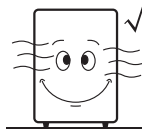

Ventilate well



Avoid exposing to the sun and rain

Electrical Safety Matters

1. Plug and pull plug is strictly prohibited when wet, the plug must be unplugged before maintenance and cleaning work.
2. Must ensure that the socket is equipped with grounding wire, and safe grounding
3. The electrical control system has more than 36V voltage, the use of not free to open and touch. If necessary, please contact the manufacturer or qualified professional and technical personnel.
4. The power connection should be marked according to the nameplate, use the specified power supply, and determine the wire specifications used in the connection circuit can meet the requirements. Please use special power outlet and fuse if necessary.
5. When the ice machine is stopped, the power plug should be unplugged or cut off the power supply.

Maintenance

In order to improve the reliability and service life of the ice maker, and to avoid the increase of the energy consumption coefficient of the ice production, the maintenance and maintenance should be carried out according to the requirements of this manual.

1. Often clean the environment around the ice maker to keep clean, do not plug the ice machine in the case of ventilation shutters.

2. Cleaning of the shell can be cleaned with a neutral cleaning agent, and then wipe clean with a rag which is made of soft material. Commercial stainless steel cleanser and polishing agent can be used when necessary.

3. Filter element should be checked regularly. Most of the ordinary filter element is replaced in half a year, and the senior core should be replaced on time according to the description.

4. Water pipes can be washed directly when the water tank and the ice storage barrel are cleaned. Do not let water pressure is too large, do not directly flush the water pump and the above part of the ice, to prevent the leaching circuit part.

5. Air-cooled ice machine condenser maintenance : three months to clean an air-cooled condenser. A vacuum cleaner with a soft brush or a brush is arranged in the direction of the fin to avoid the damage of the fin to affect the refrigerating efficiency.

6. Maintenance of the wintering : in addition to turning off the water source and power supply, the water tank of the ice machine is also needed, residual water in the inlet and drain pipes.



Any maintenance of the ice machine is not within the manufacture' s warranty.



If the scale of the ice machine is serious, or the waterway is blocked, please call the after-sale service telephone. There will be a charge for door-to-door service.



Before cleaning and maintenance work, be sure to turn off the water and power, pull out the plug.



The wind condenser fin edge is sharp, please be careful when cleaning.



The filter cartridge should be replaced periodically.

Ice Maker Work Steps

The working steps of the ice maker are divided into three parts :

1. The automatic cleaning of the ice machine (once, time 2 minutes)

When each ice maker starts, the automatic 2 minute cleaning program is automatically carried out to clean the floating objects in the ice grid and the tank. In 2 minutes the sink uninterrupted water, pump operation. The user can hear the noise of the pump work flow from the top of the ice grid down into the sink, and then overflow from the sink, from the drain outlet of the ice storage bucket.

2, ice (cycle work, the longest 40 minutes)

After the completion of automatic cleaning, the pump will delay 45 seconds to start, and then the ice began. When making ice, the water pump works continuously from above the ice grid to the sink, and the water will slowly become cold until it freezes. Ice thickness is measured by the ice thickness detector during the ice making process. When the thickness of the test is reached, the program will turn to the de-icing step. If the gap of the ice thickness detector is too large, it will be forced into the de-icing program after more than 40 minutes of ice making time.

3. De-icing (cycle work, up to 4 minutes)

In the de-icing procedure, ice will be heated, ice and ice grid will be the connection will be melted, when the ice due to weight and can not be attached to the ice grid, it will fall off, complete a de-icing process.

When the ice falls, the water plate will be turned over, and then the water retaining plate will be reset due to the dead weight, and then the machine starts to make ice again. When the ice bucket is too much ice, the ice block can not be reset, and the control chip is judged to be full of ice and temporarily shut down until the water retaining plate is reset.

Fault self-diagnosis

1. Pump -- can directly observe whether there is water from the ice grid up, if there is no pump failure.

2. Refrigeration--after 10 minutes of ice making, the water in the sink will be significantly cooler, and you can feel the water temperature directly by touching the ice grid or running water.

3. Influent-- one by one in the automatic cleaning process can be observed in the tank overflow pipe constantly flowing into the ice storage tank. In the process of ice making, you can put your hand into the water tank to feel the amount of water, the normal situation accounts for more than half of the sink.

Fault Detection

Fault	Possible Cause	Solution
Ice maker does not start.	Poor contact of socket.	Replace the socket.
	Ice storage bin is full of ice.	Remove the ice, the machine will run automatically.
	The cover of ice tray does not reset.	Adjust the cover to make it reset free.
Ice maker shuts down after operation	The water supply has not been opened or not connected firmly.	Recheck the water supply.
	Ice maker didn' t be placed horizontally.	Adjust the feet to be horizontal.
	High-voltage temperature control switch action.	Open the front panel, clean the condenser.
Lack of ice production.	Didn' t clean more than two months .	Open the front panel, clean the condenser.
	The water temperature is too high (Usually it happens in summer).	
	The environment temperature is too high.	Clean up the surrounding sundries and use electric fan to makes the temperature cool down and the air circulating.
	The environment space is small or closed.	Clean up the surrounding sundries to make air circulating.
	The water inlet valve fails and keeps open (the water tank is overflowing).	Replace the water inlet valve.
The transparency of ice cube is poor or the shape of the ice is incomplete.	Improper adjustment of ice thickness detector.	Reset the ice thickness detector
	The water quality is poor.	Install the filter, replace the filter element
	The water tank and ice tray is too dirty.	Clean the ice maker and replace the filter element.
	The water inlet valve filter screen is dirty.	Clean the water inlet valve filter screen.
	Large amount of running water above ice tray.	Tighten silicon tube of water pump, regulate water flow.
	The drain valve fails and keeps close (Split ice maker).	Replace the drain valve.
The ice cube can not drop from the ice tray.	The ice is too thick.	Adjust the Ice thickness.
	The ice detector is dirty and loose.	Clear the probe and check the connection.
Excessive noises.	The ice maker placed instability, foot hangs in the air.	Place the ice maker smoothly.
	The shell of the ice maker touch other objects.	Avoid touching other objects.
The shell of the ice maker has condensed water.	The door of ice storage bin is not completely closed.	Completely shut down the ice storage tank.
	Working in a high temperature and humid environment.	Normal phenomenon.

Before calling for service

If the ice maker is abnormal, please confirm the following contents before making a phone call :

1. Is the water source supply of the ice maker normal?

The method of inspection is to loosen the ice water inlet (6" joints) behind the machine, when loosening to a certain extent, the water will leak out. The water source supply will be normal when the water is exuded for a long time, otherwise, there is no water.

2. Whether the ice maker has been connected to the power supply or not?

The ice maker produced by our company is fully automatic without manual operation. You just need to connect the power supply and open the red switch on side of the back of the ice maker. Please let the person who understand the electricity to check whether the ice maker is electrified , focus on checking the plug base.

3. Model and series No. of our ice maker.

There is model and series No. nameplate on the side panel of the machine.



Failure due to user' s reasons (such as no water supply, no electricity supply, environmental factors, etc.) Door-to-door service charges will be charged



When checking the water source, do not completely unscrew the ice making inlet interface to prevent high pressure waterjetting.



Plastic parts of the ice maker do not belong to the scope of warranty.

Warranty

1. Our company undertakes to guarantee the machine warranty period of one year, in the warranty period, free of artificial service and replacement of parts.
2. The plastic parts of the machine are not covered by the warranty.
3. Our company's warranty is limited liability, do not bear all the joint and several liability in addition to the ice maker itself.
4. Our company's warranty scope does not include the daily maintenance, cleaning or the maintenance and failure caused by not installing or using in accordance with the instructions.
5. The warranty service shall be completed by the agency dealer or maintenance organization authorized by our company.

Out-of-service machine treatment

The insulating material between the metal shell and the ice storage bin is combustible polyurethane foaming material. After the machine is waste, please treat it according to the national or local regulations on the treatment of combustible waste.



The instruction is the undivided part of the ice maker.
The user must keep it properly.