

# INSPIRE 2

User Manual V1.2

2017.03

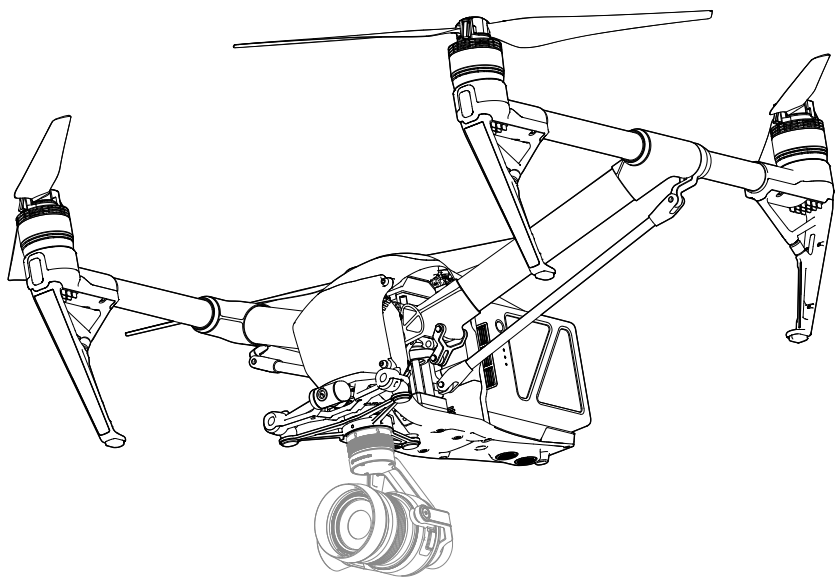

## Searching for Keywords

Search for keywords such as “battery” and “install” to find a topic. If you are using Adobe Acrobat Reader to read this document, press Ctrl+F on Windows or Command+F on Mac to begin a search.

## Navigating to a Topic

View a complete list of topics in the table of contents. Click on a topic to navigate to that section.

## Printing this Document

This document supports high resolution printing.

# Using this manual

## Legends

 Warning

 Important

 Hints and Tips

 Reference

## Before Flight

The following tutorials and manuals have been produced to ensure you to make full use of your Inspire 2.

1. In the Box
2. Safety Guidelines and Disclaimer
3. Quick Start Guide
4. Intelligent Flight Battery Safety Guidelines
5. User Manual

Watching all the tutorial videos and reading the Disclaimer before flight is recommended. Afterwards, prepare for your first flight by using the Quick Start Guide. Refer to this manual for more comprehensive information.

## Watch the video tutorials

Please watch the tutorial video below to learn how to use Inspire 2 correctly and safely:

<http://www.dji.com/inspire-2/info#video>



## Download the DJI GO™ 4 app

Download and install the DJI GO 4 app before use. Scan the QR code or visit "<https://m.dji.net/djigo4>" to download the app.



For the best experience, use mobile device with Android V 4.4 or above. Requires iOS 9.0 or later.

## Download the DJI ASSISTANT™ 2

<http://www.dji.com/inspire-2/info#downloads>

# Contents

<b>Using this manual</b>	2
Legends	2
Before Flight	2
Watch the video tutorials	2
Download the DJI GO 4 app	2
Download the DJI ASSISTANT 2	2
<b>Product Profile</b>	5
Introduction	6
Feature Highlights	6
Assemble the Aircraft	6
Preparing Remote Controller	8
Aircraft Diagram	9
Remote Controller Diagram	10
<b>Aircraft</b>	12
Flight Controller	13
Flight Mode	13
Flight Status Indicator	14
Return-to-Home (RTH)	15
TapFly	19
ActiveTrack	21
Tripod Mode	23
Spotlight Pro	23
Vision System and Infrared Sensing System	24
Flight Recorder	28
Attaching and Detaching the Propellers	28
DJI Intelligent Flight Battery	28
<b>Remote Controllers</b>	34
Remote Controller Profile	35
Remote Controller Operations	35
Dual Remote Controllers Mode	40
Remote Controller Status LED	42
Linking the Remote Controller	43
Used with the DJI Focus	44

<b>Gimbal and Camera</b>	45
Camera	46
Gimbal	47
Using CINESSD	49
<b>DJI GO 4 App</b>	51
Camera	52
Editor	55
SkyPixel	55
Me	55
<b>Flight</b>	56
Flight Environment Requirements	57
Flight Limits and No-Fly Zones	57
Preflight Checklist	60
Calibrating the Compass	61
Auto Take-off and Auto Landing	62
Starting/Stopping the Motors	62
Stop the Motor Mid-flight	63
Flight Test	63
<b>Appendix</b>	65
Specifications	66
Upgrading the Firmware	70
Compliance Information	72
After-Sales Information	74

# Product Profile

---

This chapter describes the features of Inspire 2, instructs you to assemble the aircraft and explains the components on the aircraft and remote controllers.

# Product Profile

## Introduction

The Inspire 2 is a powerful aerial film making system with class leading agility and speed, redundancy features for maximum reliability, and new, smart features that make capturing complex shots easy. The camera unit is now independent from image processor so that you have the flexibility to choose the perfect gimbal and camera system for each of your scenes. Dual frequency support in the remote controller makes the HD video downlink more efficient and more stable.

## Feature Highlights

Upgraded Tapfly™ and ActiveTrack™ commands in the DJI GO 4 app, the Inspire 2 flies anywhere visible on-screen with a tap and tracks moving subjects effortlessly.

**Flight Controller:** The flight controller has been updated to provide a safer, more reliable flight experience. A new flight recorder stores critical data from each flight. A system of visual sensors enhance hovering precision when flying indoors or in environments where GPS is unavailable. Dual IMUs and compasses design provides redundancy.

**HD Video Downlink:** The low-latency long range (up to 4.3mi (7km)) HD downlink is powered by an enhanced version of DJI LIGHTBRIDGE™. Support of 2.4 GHz and 5.8 GHz ensures a more reliable connection in environments with more interference.

**Camera and Gimbal:** The camera unit is now independent from image processor so that you have the flexibility to choose the perfect gimbal and camera system for each of your scenes. This means that regardless of which camera you choose, you have the same powerful processing backing it, and when using the ZENMUSE™ X5S, the ability to capture RAW videos. Lossless video (in CinemaDNG and ProRes format), and DNG RAW photo burst shooting will be available when DJI CINESSD™ used.

**Intelligent Flight Battery:** The new DJI Intelligent Flight Battery features upgraded battery cells and an advanced power management system providing up to 25-minutes of flight with a Zenmuse X5S and 27-minutes with a Zenmuse X4S.

## Assemble the Aircraft

### Unlocking Travel Mode

The aircraft is in Travel Mode during delivery. Follow these steps to change it to Landing Mode before your first flight:

1. Insert the battery pair.
2. Press the power button a minimum of five times.
3. Unfold the landing gear to Landing Mode and power on automatically.

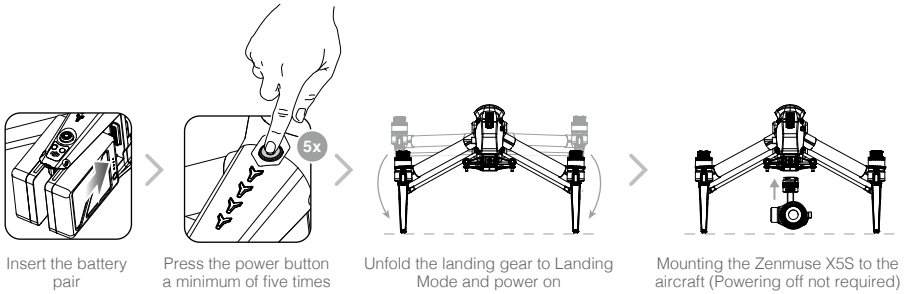

- Battery must be fully charged before using it for the first time. Refer to "Charging the Intelligent Flight Battery" for more information .
- The aircraft cannot change to Landing Mode from Travel Mode with the gimbal camera attached.
- Place the aircraft on the smooth and reflective surface (e.g. table or tile) before switching between the travel modes to the landing mode.
- Keep your hands away from the transformation mechanism when unfolding the landing gear.
- Make sure to press the battery remove button when removing the battery.
- Follow these steps to enter Travel Mode: Press the power button at least 5 times then detach the gimbal and the propellers. Place the aircraft on a smooth surface and wait as it changes into Travel Mode, then press the Remove Battery Button and remove the batteries.

### Mounting the Zenmuse X5S to the Inspire 2

1. Remove the Gimbal Cap from the Zenmuse X5S.
2. Press the gimbal and camera release button on the Inspire 2. Rotate to remove the Gimbal Cap from the Inspire 2.
3. Align the white dot on the gimbal to the red dot on Inspire 2 and insert the gimbal.
4. Rotate the Gimbal Lock to the locked position by aligning the red dots.

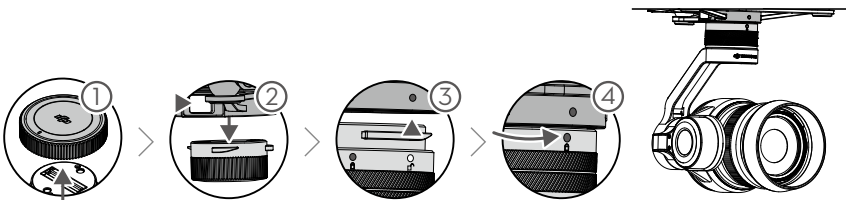

- Always ensure that the DJI Gimbal Connector 2.0 on the Inspire 2 is in the right position when mounting, otherwise the camera will not mount.
- Remove the lens cap when the Zenmuse X5S is in use.
- Always power off the aircraft before removing the gimbal camera.

## Attaching 1550T Quick Release Propellers

Following the steps below to attach the 1550T quick release propellers.

1. Pair the propellers and motors with arrows of the same color (red or white).

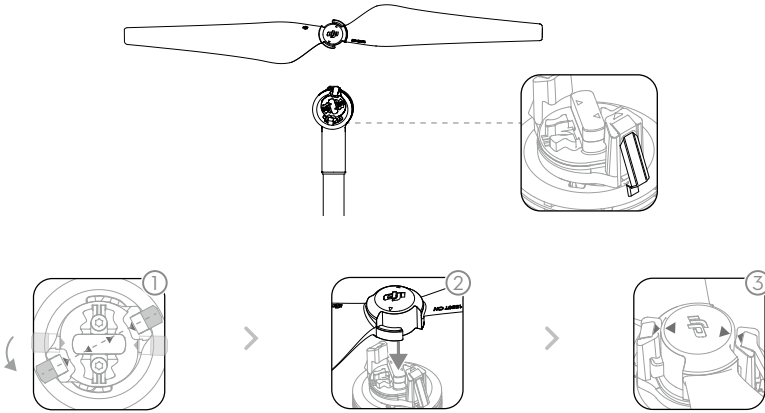

Press down the spring pad and rotate the propeller lock until the arrows are aligned and you hear a click.

Attach the propeller onto the motor.

Again, rotate the propeller lock until you hear a click.

 Make sure to press down the spring pad before rotating the propeller lock.

## Preparing Remote Controller

Tilt the Mobile Device Holder to the desired position then adjust the antenna as shown.

1. Press the button on the side of the Mobile Device Holder to release the clamp, adjust it to fit then attach your mobile device.
2. Connect your mobile device to the remote controller with a USB cable.
3. Plug one end of the cable into your mobile device, and the other end into the USB port on the back of the remote controller.

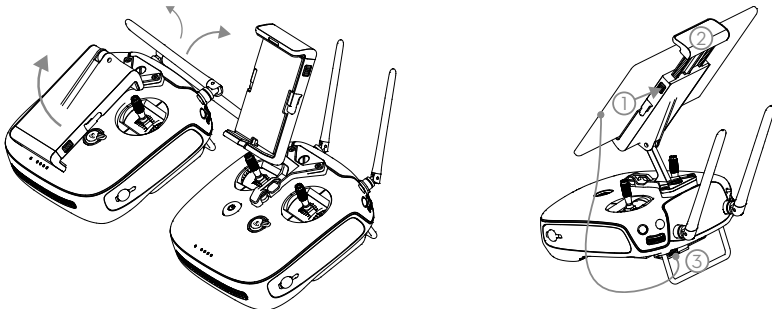

## Aircraft Diagram

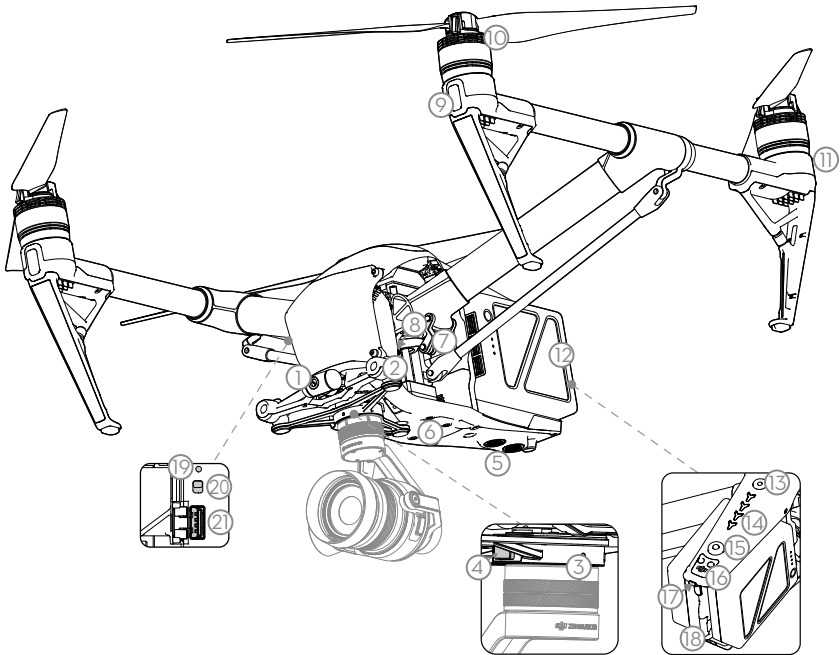

- |  |                                   |
|--|-----------------------------------|
| [1] FPV Camera   | [11] Rear LEDs                    |
| [2] Forward Vision System                                      | [12] Intelligent Flight Batteries |
| [3] DJI Gimbal Connector V2.0 (DGC2.0)                         | [13] Power Button                 |
| [4] Gimbal and Camera Detach Button                            | [14] Battery Level Indicators     |
| [5] Downward Vision System                                     | [15] Battery Remove Button        |
| [6] Extended Device Maounting Position                         | [16] Upward Infrared Sensor       |
| [7] Transformation Mechanism                                   | [17] Aircraft Status Indicator    |
| [8] Control and Processing Center<br>(with Micro SD Card Slot) | [18] DJI CINESSD Slot             |
| [9] Front LEDs   | [19] Linking Button               |
| [10] Propulsion System (with Motors, Propellers, etc.)         | [20] USB Mode Switch              |
|  | [21] USB Port                     |

## Remote Controller Diagram

**[1] Power Button**

Used to turn the Remote Controller on and off.

**[2] Transformation Switch**

Toggle the switch up or down to raise or lower the landing gear during flight.

**[3] Return-to-Home (RTH) Button**

Press and hold the button to initiate Return to Home (RTH).

**[4] Control Sticks**

Controls the orientation and movement of the aircraft.

**[5] Status LED**

Displays the Remote Controller's system status.

**[6] Battery Level LEDs**

Displays the battery level of the Remote Controller.

**[7] Power Port**

Connect to the Charger to charge the battery of the remote controller.

**[8] Mobile Device Holder**

Securely mounts your mobile device to the remote controller.

**[9] Antennas**

Relays aircraft control and video signal.

**[10] Handle Bar**

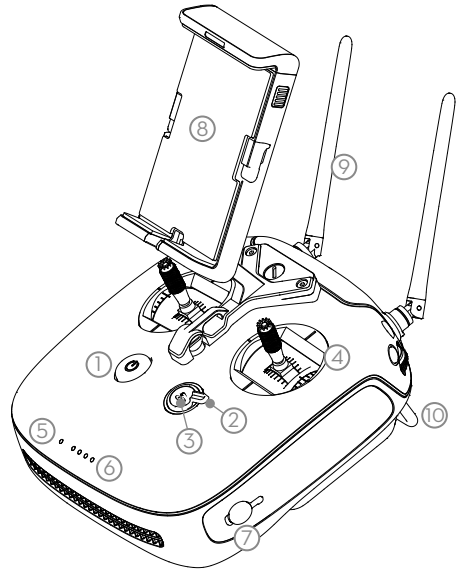

**[11] Control Dial (Gimbal/FPV)**

Use this dial to control gimbal tilt. In the gimbal Free Mode, pressing and holding the C1 Button and rotating the control dial adjusts gimbal pan. To adjust the tilt of the FPV camera, press and hold the C2 Button and rotate the control dial.

**[12] Camera Settings Dial**

Turn the dial to adjust camera settings. (Only functions when the remote controller is connected to a mobile device running the DJI GO 4 app.)

**[13] Record Button**

Press to start recording video. Press again to stop recording.

**[14] Flight Mode Switch**

Switch between P-mode, S-mode, and A-mode.

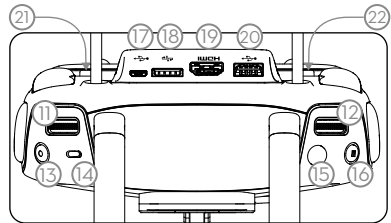

**[15] Shutter Button**

Press the Shutter Button to take a photo. Photos can also be captured during video recording.

**[16] Pause Button**

Press once to allow the aircraft to exit from TapFly, ActiveTrack and Advanced mode.

**[17] Micro USB Port**

Use this port to upgrade the firmware.

**[18] CAN Bus**

Reserved extended port.

**[19] HDMI A Port**

HDMI A Port is for video output.

**[20] USB Port**

Connection to mobile device for DJI GO 4 app.

**[21] C1 Button**

Customizable through the DJI GO 4 app.

**[22] C2 Button**

Customizable through the DJI GO 4 app.

# Aircraft

---

This chapter describes the features of the Flight Controller, Vision System and the Intelligent Flight Battery.

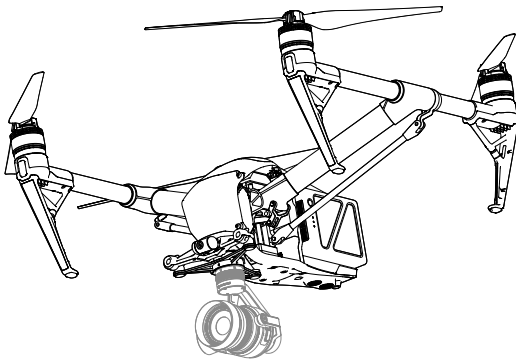

# Aircraft

## Flight Controller

The Inspire 2 flight controller features several important upgrades. Safety modes include Failsafe and Return-to-Home. These features ensure the safe return of your aircraft if the control signal is lost. The flight controller can also save critical flight data from each flight to the on-board storage device. The new flight controller also provides increased stability and a new air braking feature.

## Flight Mode

Three flight modes are available. The details of each flight mode are found in the section below:

### P-mode (Positioning) :

P-mode works best when the GPS signal is strong. The aircraft utilizes the GPS and Forward and Downward Vision Systems to locate itself, automatically stabilize, and navigate between obstacles. Advanced features such as TapFly and ActiveTrack are enabled in this mode.

When the Forward Vision System is enabled and lighting conditions are sufficient, the maximum flight attitude angle is 25°. When forward obstacle sensing are disabled, the maximum flight attitude angle is 35°.

When the GPS signal is weak and lighting conditions are too dark for the Forward and Downward Vision Systems, the aircraft will only use its barometer for positioning to control altitude.

Note: P-mode requires larger stick movements to achieve high speeds.

### S-mode (Sport):

The aircraft is using GPS for positioning. As Forward and Downward Vision Systems are disabled, the aircraft will not be able to sense and avoid obstacles when in Sport Mode. Ground Station and the Intelligent Flight functions are also not available in Sport Mode.

Note: Aircraft responses are optimized for agility and speed making it more responsive to stick movements.

### A-mode (Attitude):

When neither the GPS nor the Vision System is available, the aircraft will only use its barometer for positioning to control the altitude. Ground Station and the Intelligent Flight functions are also not available in A-mode.



**• The forward Vision System is disabled in S-mode (Sport), which means the aircraft will not be able to automatically avoid obstacles in its flight path. Be vigilant and stay clear of nearby obstacles.**

• The aircraft's maximum speed and braking distance are significantly increased in S-mode (Sport). A minimum braking distance of 164 feet (50 meters) is required in windless conditions.

• The aircraft's responsiveness is significantly increased in S-mode (Sport), which means a small stick movement on the remote controller will translate into a large travel distance of the aircraft. Be vigilant and maintain adequate maneuvering space during flight.

• The aircraft's descent speed is significantly increased in S-mode (Sport). A minimum braking distance of 164 feet (50 meters) is required in windless conditions.



Use the Flight Controller mode switch to change the flight mode of the aircraft.

---





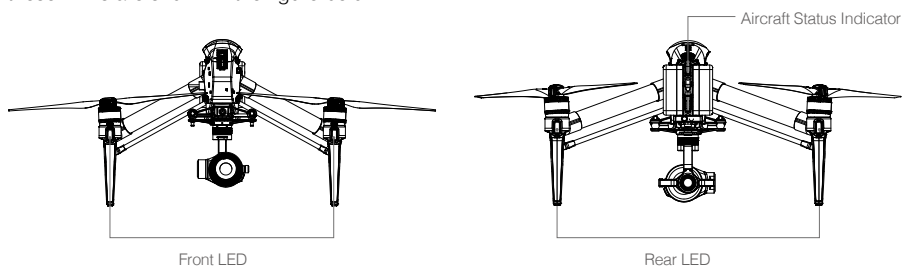







## Flight Status Indicator

The Inspire 2 comes with the Front LED, Rear LED and Aircraft Status Indicator. The positions of these LEDs are shown in the figure below:



The Front LEDs show the orientation of the aircraft. The Front LEDs glow solid red when the aircraft is turned on to indicate the front (or nose) of the aircraft (Front and rear LEDs can be turned off in the DJI GO 4 app). The Aircraft Status Indicator communicates the system status of the flight controller. Refer to the table below for more information about the Aircraft Status Indicator.



### Aircraft Status Indicator Description

Normal		
 .....	Red, yellow, green, blue and purple flashes	Turning On and Self Diagnostic Testing
 ×4	Four yellow flashes	Warming Up
 .....	Slow green flashing	P-mode with GPS*
 ×2 .....	Two green flashes	P-mode with Forward and Downward Vision Systems*
 .....	Slow yellow flashing	No GPS and Forward and Downward Vision Systems
 .....	Fast green flashing	Braking
Warning		
 .....	Fast yellow flashing	Remote Controller Signal Lost
 .....	Slow red flashing	Low Battery Warning
 .....	Fast red flashing	Critical Low Battery Warning
 .....	Red flashing	IMU Error
 —	Solid Red	Critical Error
 .....	Fast alternating red and yellow flashing	Compass Calibration Required

\* Slow green flashes indicate P-Mode and fast green flashes indicate S-mode.

## Return-to-Home (RTH)

Return-to-Home (RTH) function brings the aircraft back to the last recorded Home Point. There are three types of RTH: Smart RTH, Low Battery RTH, and Failsafe RTH. This section describes these three scenarios in detail.

	GPS	Description
Home Point		If a strong GPS signal was acquired before takeoff, the Home Point is the location from which the aircraft launched. The GPS signal strength is indicated by the GPS icon (  ). Less than 4 bars is considered a weak GPS signal.). The aircraft status indicator will blink rapidly when the home point is recorded.



 The aircraft can sense and avoid obstacles when the Forward Vision System is enabled and lighting conditions are sufficient. The aircraft will automatically climb up to avoid obstacles and descend slowly as it returns to the home point. To ensure the aircraft returns home forwards, it cannot rotate or fly left and right during RTH while the Forward Vision System is enabled.

### Failsafe RTH

The Forward Vision System allows the aircraft to create a real-time map of its flight route as it flies. If the Home Point was successfully recorded and the compass is functioning normally, Failsafe RTH will be automatically activated if the remote controller signal is lost for more than three seconds. The aircraft will plan its return route and retrace its original flight route home. The aircraft will hover for 10 seconds at its current location. When it regains signal connection it will wait for pilot commands. The Return-to-Home process may be interrupted and the pilot given control of the aircraft if the remote controller signal connection is re-established.

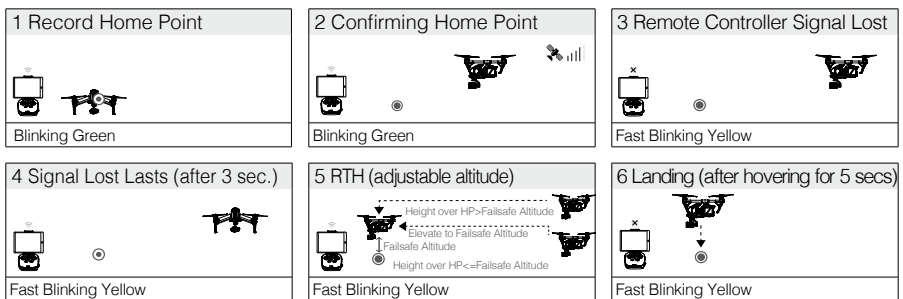
### Failsafe Illustration



-  • Aircraft cannot return to the Home Point when GPS signal is weak (  ) Less than 4 bars is considered a weak GPS signal.) or unavailable.
- Aircraft automatically descends and lands if RTH is triggered when the aircraft flies within a 65 feet (20 meters) radius of the Home Point. Aircraft will stop ascending and immediately return to the Home Point if you move the left stick if the aircraft reaches 65 feet (20 meters) altitudes or beyond during Failsafe.
- The aircraft cannot avoid obstruction during Failsafe RTH if Forward Vision System is disabled. It is important to set a suitable Failsafe altitude before each flight. Launch the DJI GO 4 app, enter "Camera" and tap  to set the Failsafe Altitude.
- User cannot control the aircraft while the aircraft is ascending to 65 feet (20 meters) from the current altitude. However, user can press RTH button once to exit ascending and regain control.

## Smart RTH

Use the RTH button on the remote controller or tap the RTH button in the DJI GO 4 app and follow the on-screen instructions when GPS is available to initiate Smart RTH. The aircraft will then automatically return to the last recorded Home Point. Use the remote controller to control the aircraft's speed or altitude to avoid a collision during the Smart RTH process. As the aircraft returns, it will use the primary camera to identify obstacles as far as 300m in front, allowing it to plan a safe route home. Press and hold the Smart RTH button once to start the process, and press the Smart RTH button again to terminate the procedure and regain full control of the aircraft.

## Low Battery RTH (Can be turned off in DJI GO 4 app)

The low battery level failsafe is triggered when the DJI Intelligent Flight Battery is depleted to a point that may affect the safe return of the aircraft. Users are advised to return home or land the aircraft immediately when prompted. The DJI GO 4 app will display a notice when a low battery warning is triggered. The aircraft will automatically return to the Home Point if no action is taken after a ten-second countdown. The user can cancel the RTH procedure by pressing the RTH button on the remote controller. The thresholds for these warnings are automatically determined based on the aircraft's current altitude and distance from the Home Point.

The aircraft will land automatically if the current battery level can only support the aircraft long enough to descend from its current altitude. The user can still use the remote controller to alter the aircraft's orientation during the landing process.

The Battery Level Indicator is displayed in the DJI GO 4 app, and is described below:

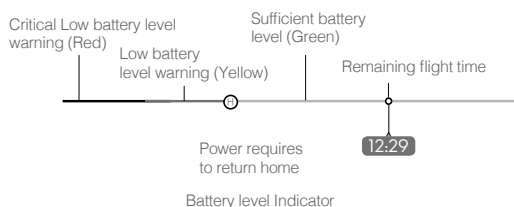

Battery Level Warning	Remark	Aircraft Status Indicator	DJI GO 4 App	Flight Instructions
Low battery level warning	Battery power is low. Land the aircraft.	Aircraft status indicator blinks RED slowly.	Tap "Go-home" to have the aircraft return to the Home point and land automatically, or "Cancel" to resume normal flight. If no action is taken, the aircraft will automatically go home and land after 10 seconds. Remote controller will sound an alarm.	Fly the aircraft back and land it as soon as possible, then stop the motors and replace the battery.

Critical Low battery level warning	The aircraft must land immediately.	Aircraft status indicator blinks RED quickly.	The DJI GO 4 app display will flash red and the aircraft will start to descend. The remote controller will sound an alarm.	Allow the aircraft to descend and land automatically.
Estimated remaining flight time	Estimated remaining flight based on current battery level.	N/A	N/A	N/A



- When the Critical low battery level warning is triggered and the aircraft begins to land automatically, push the left stick upward to make the aircraft hover at its current altitude, giving you an opportunity to navigate to a more appropriate landing location.
- The colored zones and markers on the battery level indicator bar reflect the estimated remaining flight time. They are automatically adjusted according to the aircraft's current location and status.

### Failsafe Safety Notices



The aircraft cannot avoid obstruction during the Failsafe RTH when the Forward Vision System is disabled. Therefore, it is important to set a suitable Failsafe altitude before each flight. Launch the DJI GO 4 app, enter Camera and tap to set the Failsafe Altitude.



If the aircraft is flying under 65 feet (20 meters) and Failsafe (including Smart RTH, Lower Battery RTH ) is triggered, the aircraft will first automatically ascend to 65 feet (20 meters) from the current altitude. You can only cancel the ascending by exiting the Failsafe.

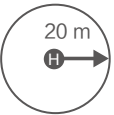

Aircraft automatically descends and lands if RTH is triggered when the aircraft flies within a 65 feet (20 meters) radius of the Home Point. Aircraft will stop ascending and immediately return to the Home Point if you move the left stick if the aircraft reaches 65 feet (20 meters) altitudes or beyond during Failsafe.



Aircraft cannot return to the Home Point when GPS signal is weak ( [ ] displays less than four bars) or unavailable.



if you move the left stick after the aircraft rises above 65 feet (20 meters) but below the pre-set Failsafe RTH altitude, the aircraft will stop ascending and immediately return to the Home Point.

## Obstacle Avoidance During RTH\*

Aircraft can now sense and actively attempt to avoid obstacles during RTH, provided that the lighting conditions are adequate for the Forward Vision System. Upon detecting an obstacle, the aircraft will act as follows:

1. The aircraft will use the primary camera to identify obstacles as far as 984 feet (300 meters) in front, allowing it to plan a safe route home.
2. The aircraft decelerates when an obstacle is sensed at 49 feet (15 meters) ahead.
3. The aircraft stops and hover then start ascending vertically to avoid the obstacle. Eventually, the aircraft will stop climbing when it is at least 16 feet (5 meters) above the detected obstacle.
4. Failsafe RTH procedure resume, the aircraft will continue flying to the Home Point at the current altitude.

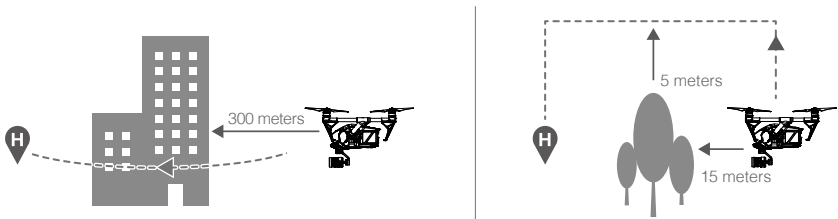

\*Coming soon.



- The Obstacle Sensing function is disabled during RTH descent. Proceed with care.
- To ensure the aircraft returns home forwards, it cannot rotate during RTH while the Forward Vision System is enabled.
- The aircraft cannot avoid obstacles beside or behind the aircraft.

## Landing Protection Function

Landing Protection will activate during auto landing.

1. Landing Protection determines whether the ground is suitable for landing. If so, the Inspire 2 will land gently.
2. If Landing Protection determines that the ground is not suitable for landing, the Inspire 2 will hover and wait for pilot confirmation. The aircraft will hover if it detects the ground is not appropriate for landing even with a critically low battery warning. Only when the battery level decreases to 0% will the aircraft land. Users retain control of aircraft flight orientation.
3. If Landing Protection is inactive, the DJI GO 4 app will display a landing prompt when the Inspire 2 descends below 0.7 meters. Tap to confirm or pull down the control stick for 2 seconds to land when the environment is appropriate for landing.



Landing Protection will not be active in the following circumstances:

- When the user is controlling the pitch/roll/throttle sticks (Landing ground detection will re-activate when control sticks are not in use)
- When the positioning system is not fully functional (e.g. drift position error)
- When the downward vision system needs re-calibration
- When light conditions are not sufficient for the downward vision system
- If an obstacle is within 1-meter of the aircraft, the aircraft will descend to 0.7m above the ground and hover. The aircraft will land upon with user confirmation.

## TapFly

### Introduction

With the TapFly feature, users can now tap on the mobile device screen to fly in the designated direction without using the remote controller. The aircraft will automatically avoid obstacles it sees or brake and hover provided that the lighting is appropriate ( $< 300$  lux) nor too bright ( $> 10,000$  lux).

### Using TapFly

Ensure the battery level is more than 50% for the Intelligent Flight Battery. And the aircraft is in P-mode. Then follow the steps below to use TapFly:

1. Take off and ensure the aircraft is flying at least 6 feet (2 meters) above the ground.

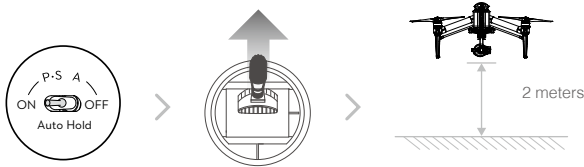

2. Launch the DJI GO 4 app and tap , then tap , read and understand the prompts.

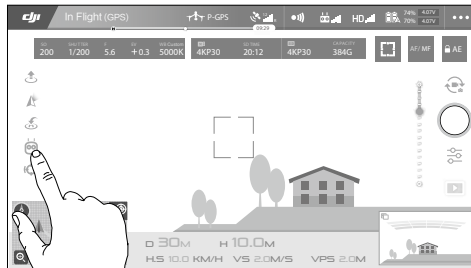

3. Tap once on the target direction and wait for  icon to appear. Tap again to confirm the selection and the aircraft will automatically fly towards the target direction.

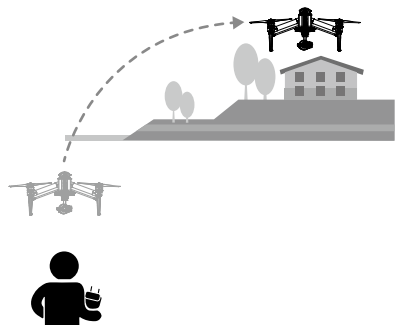
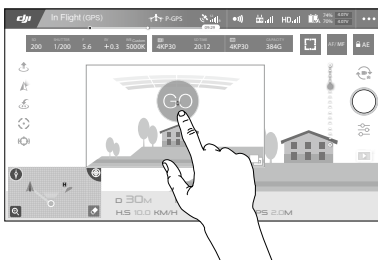

- ⚠ • DO NOT guide the aircraft to fly towards people, animals, small and fine objects (e.g. tree branches and power lines) or transparent objects (e.g. glass or water).
- Watch for the obstacles in the flight path and stay clear of them.
- There may be deviations between the expected and the actual flight path of TapFly selection.
- The selectable range for the target direction is limited. You cannot make a TapFly selection close to the upper or lower edge of the screen.
- TapFly Mode may not work properly when the aircraft is flying over water or snow covered areas.
- Be extra cautions when flying in dark (< 300 lux ) or bright (>10,000 lux) environments.

☀: Enable control stick control of the gimbal inside the DJI GO 4 app to control gimbal orientation using the remote controller. When control sticks are in use, the gimbal will automatically change into Free Mode. In this situation, the control stick used to control pitch on the aircraft now controls gimbal pitch, and the control stick used to control aircraft roll now controls gimbal pan. The left dial now controls flight speed.

After confirming the TapFly selection, the aircraft will fly in the direction marked by the  icon. Note that you can still use the control stick to control the movement of the aircraft during the flight.

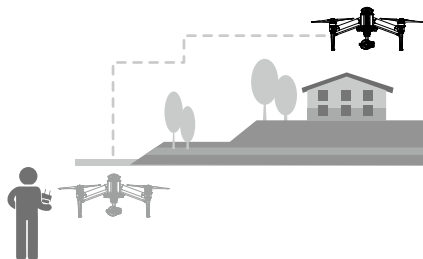
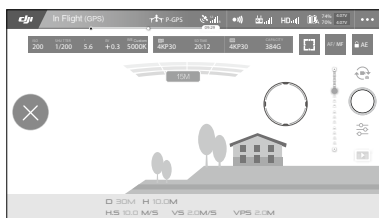

The aircraft automatically adjusts its speed when it senses an obstacle in front, or if it flies too close to the ground. The DJI GO 4 app will show a prompt if the aircraft flies over an obstacle or to the left or right of the obstacle. However, this feature should not be relied upon for navigation between obstacles. Failsafe procedures will override TapFly. If the GPS signal weakens, the aircraft will exit autonomous flight and return to home.

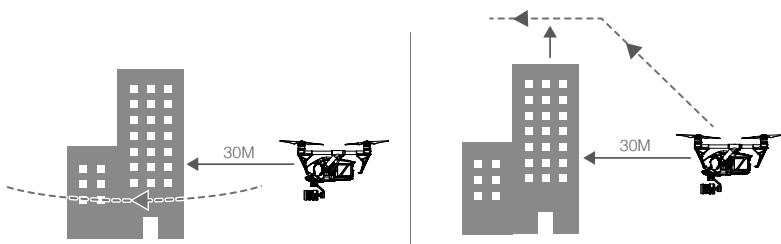

### Exit TapFly

Use the following methods to exit TapFly:

1. Tap "  " button on the screen.
2. Pull back the pitch stick on the remote controller and hold for more than 3s.
3. Press the Intelligent Flight Pause button on the remote controller.

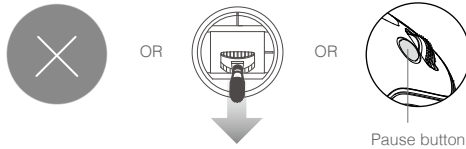

Aircraft will stop and hover after exiting from TapFly. Tap a new target direction to continue flying or begin manual flight.

## ActiveTrack

ActiveTrack allows you to mark and track a moving object on your mobile device screen. The aircraft will automatically avoid obstacles in its flight path. No external tracking device is required. The Inspire 2 can automatically identify and trace bikes and other vehicles, people and animals, and use different tracking strategies for each.

### Using ActiveTrack

Ensure the Intelligent Flight Battery has more than 50% power and the aircraft is in P-mode. Then follow the steps below to use ActiveTrack:

1. Take off and hover at least 6 feet (2 meters) above the ground.

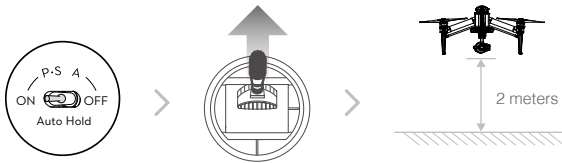

2. Launch the DJI GO 4 app and tap , then tap , read and understand the prompts.

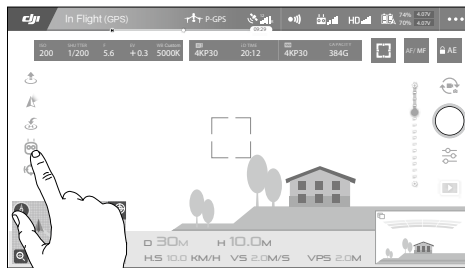

3. Tap on the subject you want to track then tap to confirm selection. If the subject is not automatically recognized, drag a box around it. The box  will turn green when tracking is in progress. If the box turns red, the object could not be identified and you should try again.

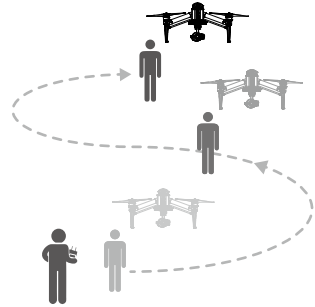
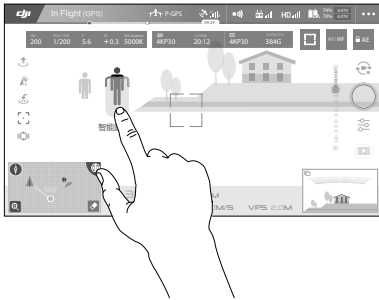

- ⚠ DO NOT select an area containing people, animals, small, fine objects (e.g. tree branches and power lines) or transparent objects (e.g. glass or water surface).
- Stay clear of obstacles near the flight path, particularly when the aircraft is flying backward.
- Be extra vigilant when using ActiveTrack in any of the following situations:
  - a) The tracked subject is not moving on a level plane.
  - b) The tracked subject changes shape drastically while moving.
  - c) The tracked subject could be blocked or out of sight for a long time.

ActiveTrack includes following functions:

Trace	Profile
<p>The aircraft tracks the subject at a constant distance. Use the roll stick on the remote controller or the slider in DJI GO 4 app to circle the subject.</p>	<p>The aircraft tracks the subject at constant angle and distance from the side. Use the roll stick on the remote control to circle the subject.</p>

- ⚠ DO NOT select an area containing people, animals, small, fine objects (e.g. tree branches and power lines) or transparent objects (e.g. glass or water).
- Stay clear of obstacles near the flight path, particularly when the aircraft is flying backward.
- Be extra vigilant when using ActiveTrack in any of the following situations:
  - a) The tracked subject is not moving on a level plane.
  - b) The tracked subject changes shape drastically while moving.
  - c) The tracked subject could be blocked or out of sight for a long time.
  - d) The tracked subject is moving on a snowy surface.
  - e) Available light is low (< 300 lux) or high (> 10,000 lux).
  - f) The tracked subject has a similar color or pattern as its surrounding environment.

- ⚠ • You must follow local privacy laws and regulations when using ActiveTrack.
- Aircraft will not be able to avoid obstacles while in Profile or Spotlight Mode. Use these modes in open areas.

## Exiting ActiveTrack

Use the following methods to exit ActiveTrack:

1. Tap the "✕" button on the screen.
2. Press the Intelligent Flight Pause button on the remote controller.

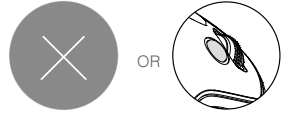

After exiting ActiveTrack, the aircraft will hover in place, at which point you may choose to fly manually, track another subject, or return to home.

## Tripod Mode

Tap the icon in the DJI GO app to enable Tripod Mode. Tripod Mode reduces the Inspire 2's maximum speed (this can be adjusted in DJI GO 4 app), and the control stick sensitivity of the remote controller is dulled to give you the precision you need for accurate framing. Tripod Mode allow the Inspire 2 to be used as a rocker arm or slide rail as in this mode it can shoot smoother, more stable footage.

- ⚠ • Only use Tripod Mode where the GPS signal is strong or light conditions are ideal for the vision system. If GPS signal is lost and the vision system cannot function, it will automatically switch to Atti mode. In this case, flight speed will increase and the aircraft cannot hover in place. Use Tripod Mode carefully.

## Spotlight Pro

Spotlight Pro is a powerful new tracking mode that allows a single pilot to capture complex, dramatic images. The gimbal will automatically adjust to keep the camera pointing at the subject. Lock onto a subject in Spotlight Pro mode and the gimbal will capture the locked subject regardless of the directions that the aircraft flies.

**Quick Mode:** Use your finger to draw a square around the object in to begin tracking.

**Composition Mode:** Use your finger to draw a square. When the subject enters the square, press the C2 button to begin tracking. Press the C2 button again to stop tracking.

In Free mode, you can control the aircraft's heading independently of the camera.

In Follow mode, the aircraft heading will be the same as that of the camera.



- ⚠ • You can drag on a subject in the DJI GO 4 app or move the gimbal control sticks to change the subject's position in the shot.
- Aircraft auto spin is enabled by default in Free Mode. It spins the aircraft in the opposite angle to gimbal rotation to avoid rotation limits during shooting.
- Spotlight Pro can be used in S-Mode, A-Mode, TapFly Mode and Tripod Mode.

## Vision System and Infrared Sensing System

The main components of the Vision System are located on the front and bottom of the Inspire 2, including [1] [2] two stereo vision sensors and [3] two ultrasonic sensors. The Vision System uses ultrasound and image data to help the aircraft maintain its current position, enabling precision hovering indoors or in environments where a GPS signal is not available. The Vision System constantly scans for obstacles, allowing the Inspire 2 to avoid them by going over, around, or hovering. The Infrared Sensing System consists [4] of two infrared modules on top side of the aircraft. These scan for obstacles on top side of the aircraft and is active in certain flight modes.

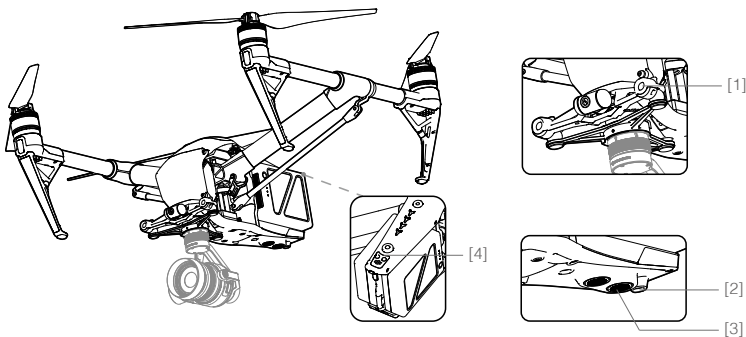

### Detection Range

The detection range of the Vision System is depicted as follow. Note that the aircraft cannot sense and avoid the obstacles that are not within the detection range.

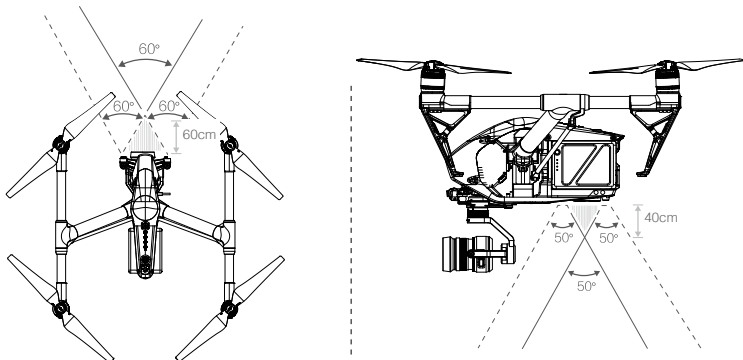

 The aircraft cannot detect objects in shadow. Fly carefully.

Ultrasonic sensor detection range is as follows.

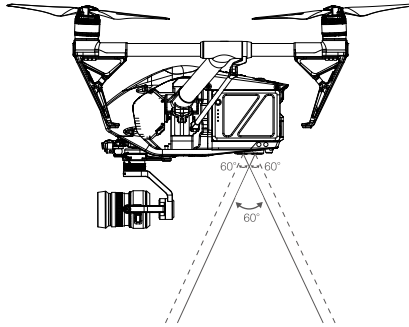

## Calibration

Forward and Downward Vision Systems cameras installed on the aircraft are calibrated on delivery. However these cameras are vulnerable to excessive impact and will require occasional calibration via DJI Assistant 2.

### Calibration via the Visual Calibration Plate

1. Ensure the aircraft is in landing mode. Power on the Intelligent Flight Battery and toggle the USB Mode Switch down.
2. Connect the Inspire 2 and the PC via a USB cable with Double A ports.
3. Launch DJI Assistant 2 and login with a DJI account.
4. Click Inspire 2 and the calibration button.

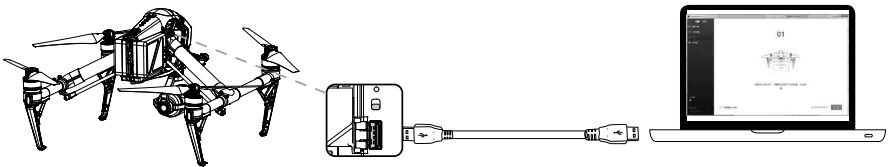

5. Place the side of visual calibration plate with the dots facing the forward vision system, and follow the instructions in the DJI Assistant 2 to complete calibration.
6. Place the aircraft straight, and ensure the dotted side of the visual calibration plate faces the downward vision system. Follow the instructions in the DJI Assistant 2 to complete calibration.

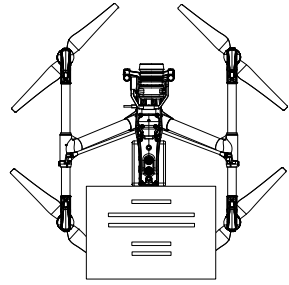
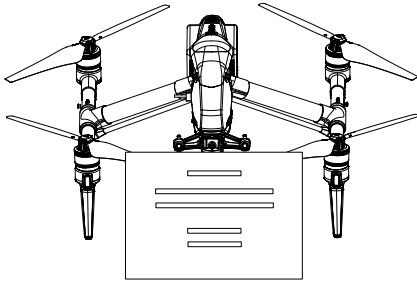

### Calibrating via Screen

Follow the steps below to calibrate the camera.



01

Point the aircraft toward the screen

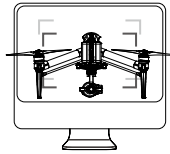

02

Align the boxes

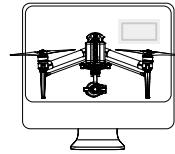

03

Pan and tilt the aircraft

---

 DO NOT power off or unplug the USB cable after calibration. Wait for data calculation.

---

### Using Vision System

Vision System is activated automatically when the Inspire 2 is powered on. No manual action is required. Vision System is typically used in the indoor environment where no GPS is available. By using the sensors on the Vision system, Inspire 2 can perform precision hovering even when no GPS is available.

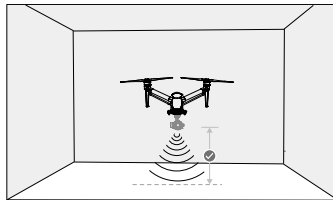

Follow the steps below to use Vision System:

1. Toggle the flight mode switch to P-mode.
2. Place the aircraft on a flat surface. Note that the Vision System cannot work properly on surfaces without clear pattern variations.
3. Turn on the aircraft. The aircraft status indicator will flash green two times, which indicates the Vision System is ready. Gently push the left stick up to lift off and the aircraft will hover in place.

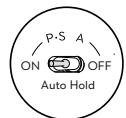

## Assisted Braking from Obstacle Sensing

Powered by the Obstacle Sensing, the aircraft will now be able to actively brake when obstacles are detected around the aircraft. Note that Obstacle Sensing function works best when lighting is adequate and the obstacle is clearly marked or textured. The aircraft must fly at no more than 31mph (50kph) to allow sufficient braking distance.

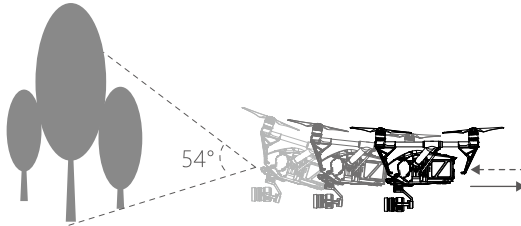

- 
- ⚠ • The forward vision system will be disabled after the landing gear lowers. Stay alert.
  - The performance of your Vision System and Infrared Sensing System are affected by the surface being flown over. Ultrasonic sensors may not be able to accurately measure distances when operating above sound-absorbing materials and the camera may not function correctly in suboptimal environments. The aircraft will switch from P-mode to A-mode automatically if neither GPS nor Vision System and Infrared Sensing System are available. Operate the aircraft with great caution in the following situations:
    - a) Flying over monochrome surfaces (e.g. pure black, pure white, pure red, pure green).
    - b) Flying over a highly reflective surfaces.
    - c) Flying at high speeds of over 31mph (50kph) at 2 meters or over 11mph (18kph) at 1 meter.
    - d) Flying over water or transparent surfaces.
    - e) Flying over moving surfaces or objects.
    - f) Flying in an area where the lighting changes frequently or drastically.
    - g) Flying over extremely dark (lux < 10) or bright (lux > 100,000) surfaces.
    - h) Flying over surfaces that can absorb sound waves (e.g. thick carpet).
    - i) Flying over surfaces without clear patterns or texture.
    - j) Flying over surfaces with identical repeating patterns or textures (e.g. tiling).
    - k) Flying over inclined surfaces that will deflect sound waves away from the aircraft.
    - l) Flying over obstacles with too small effective infrared reflective surface.
    - m) DO NOT position the sides of two aircraft toward each other to avoid interference between the 3D infrared modules.
    - n) DO NOT cover the protective glass of the infrared module. Keep it clean and undamaged.
- 
- ☀ • Keep sensors clean at all times. Dirt or other debris may adversely affect their effectiveness.
  - Vision System is only effective when the aircraft is at altitudes of 0.3 to 10 meters.
  - The Vision System may not function properly when the aircraft is flying over water.
  - The Vision System may not be able to recognize pattern on the ground in low light conditions (less than 100 lux).
  - Do not use other ultrasonic devices with frequency of 40 KHz when Vision System is in operation.
- 
- ⊗ • Keep animals away from the aircraft when Vision System is activated. The sonar sensor emits high frequency sounds that are audible to some animals.
-

## Flight Recorder

Flight data is automatically recorded to the internal storage of the aircraft. This includes flight telemetry, aircraft status information, and other parameters. To access this data, connect the aircraft to the PC through the USB port and launch the DJI Assistant 2.

## Attaching and Detaching the Propellers

### Attaching the Propellers

Refer to "Attaching Propellers" for details.

### Detaching the Propellers

Press down the spring pad and rotate the propeller lock to remove the propeller.



- Be aware of the sharp edges of the propellers. Handle with care.
  - Use only the DJI approved propellers. Do not mix propeller types.
  - Check that the propellers and motors are installed correctly and firmly before every flight.
  - Ensure that all propellers are in good condition before each flight. DO NOT use aged, chipped, or broken propellers.
  - To avoid injury, STAND CLEAR of and DO NOT touch propellers or motors when they are spinning.
  - ONLY use original DJI propellers for a better and safer flight experience.
- 

## DJI Intelligent Flight Battery

The DJI Intelligent Flight Battery has a capacity of 4280mAh, voltage of 22.8V, and smart charge-discharge functionality. It can only be charged with an appropriate DJI approved charger.

### DJI Intelligent Flight Battery Functions

1. Battery Level Display: LEDs display the current battery level.
2. Auto-discharging Function: The battery automatically discharges to below 70% of total power when it is idle (press the power button to check battery level will cause battery to exit idle state) for more than 10 days to prevent swelling. It takes around 3 days to discharge the battery to 65%. It is normal to feel moderate heat emitting from the battery during the discharge process. Discharge thresholds can be set in the DJI GO 4 app.
3. Balanced Function: Automatically balances the voltage of each battery cell when charging.
4. Over charge Protection: Charging automatically stops when the battery is fully charged.
5. Temperature Protection: The battery will only charge when the temperature is between 5 °C (41°F) and 45°C (113°F).
6. Over Current Protection: Battery stops charging when high amperage (more than 10A) is detected.
7. Over Discharge Protection: Over-discharging can seriously damage the battery. Current output will be cut off when the battery cell is discharged to 2.8V and not in flight mode. To extend flight times, over-charging protection is disabled as batteries discharge during flight. In this instance, a battery voltage below 2V, may cause a safety hazard such as a fire when charged. To prevent this, the battery will not be able to charge if the voltage of a single battery cell is below 2V. Avoid using any batteries matching this description. Always be alert to avoid serious over-discharging to prevent permanent battery damage.

8. Short Circuit Protection: Automatically cuts the power supply when a short circuit is detected.
9. Battery Cell Damage Protection: The DJI GO 4 app displays a warning message when a damaged battery cell is detected.
10. Sleep Mode: Sleep mode is entered to save power when the aircraft is not flying.
11. Communication: Battery voltage, capacity, current, and other relevant information is provided to the aircraft's to the main controller.
12. Pairing Batteries: Powered by two batteries (with battery cells connected in parallel), the Inspire 2 requires the two batteries to have similar properties, e.g. internal resistance. Pairing batteries in the beginning is recommended. Pairing can be done using the DJI GO 4 app. The DJI GO 4 app will also prompt when batteries that are not paired are in use. The Intelligent Flight Battery Charging Hub will charge paired batteries simultaneously. Stickers are provided for marking paired batteries.
13. Heating: Batteries are able to work even in cold weather, ensuring a safe flight. Refer to "Using the Battery" section for details.

**⚠** Refer to *Disclaimer* and *Intelligent Flight Battery Safety Guidelines* before use. Users take full responsibility for all operations and usage.

## Charging the Intelligent Flight Battery

The Inspire 2 Intelligent Flight Battery Charging Hub is designed for use with the Inspire 2 Battery Charger. It charges up to four Intelligent Flight Batteries simultaneously. The battery pair with more stored power will be charged first. The Charging Hub will intelligently charge batteries in sequence according to battery power levels from high to low, if batteries are not paired. Pairing can be carried out using the DJI GO 4 app. The Micro USB port is used for firmware updates.

### Overview

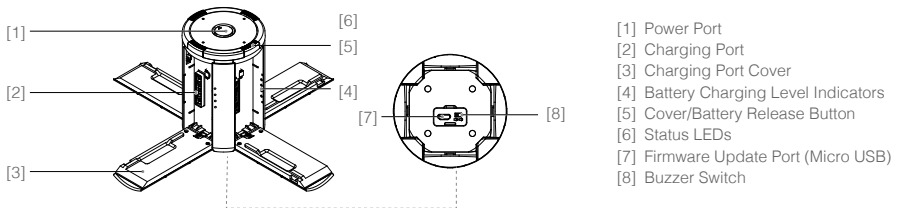

### Connecting to a Power Source

Connect the standard Inspire 2 Battery Charger to a power outlet (100-240V, 50/60Hz), then uncover the rubber cover on the power port to connect the Charging Hub to the Inspire 2 Battery Charger\*.

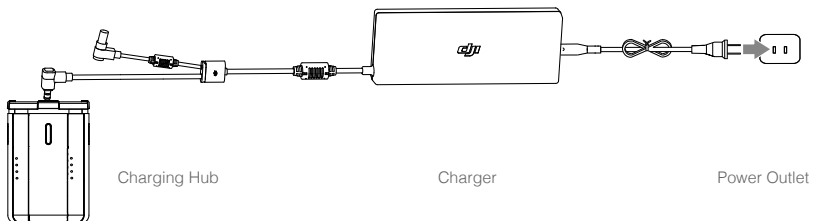

\* It will take approximately 1.5 hours to fully charge the Inspire 2 Intelligent Flight Battery, and 3 hours for the remote controller. It will take a longer time to charge the Intelligent Flight Battery and remote controller together.

### Connecting Batteries

Press the release button and open the corresponding charging port cover. Insert the Intelligent Flight Battery into the charging port to begin charging. The battery pair with more stored power will be charged first. The Charging Hub will intelligently charge batteries in sequence according to battery power levels from high to low, if batteries are not paired. Pairing can be carried out using the DJI GO 4 app. Refer to the "Status LED Description" section for more information about Status LED blinking patterns. The buzzer will begin beeping when charging is complete. Refer to the "Buzzer Beeping Description" for more information about buzzer beeping patterns.

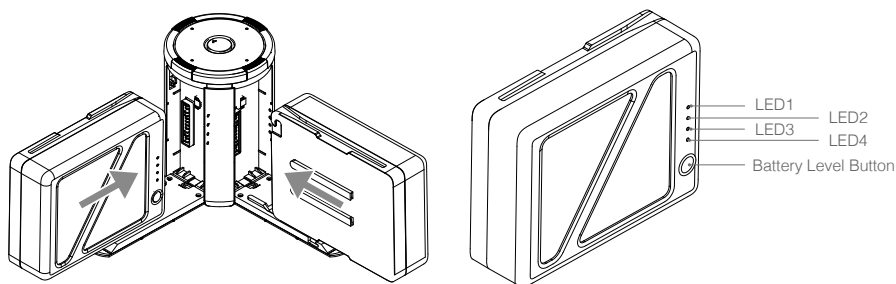

- ⚠ • Always align the grooves on the Intelligent Flight Battery with the battery slot tracks.
- Press the release button to detach batteries after charging is complete.
- DO NOT leave metal terminals exposed to open air when not in use.

### Status LED Descriptions

Status LED (Charging Hub)	Description
☀️ ..... Blinks Green	Charging
☀️ — Solid Green	Fully charged
🔴 ..... Blinks Red	Battery Charger Error. Retry with an official battery charger.
🔴 — Solid Red	Intelligent Flight Battery error
☀️ ..... Blinks Yellow	Battery temperature too high/low. Temperature must be within operating range (5°-40°C)
☀️ — Solid Yellow	Ready to charge
☀️ ... Alternating Green Blinks	Intelligent Flight Battery not detected

Battery Level Indicators while Charging (Battery)				Battery Level
LED1	LED2	LED3	LED4	
☀️	☀️	○	○	0%~50%
☀️	☀️	☀️	○	50%~75%
☀️	☀️	☀️	☀️	75%~100%
○	○	○	○	Fully Charged

### Charging Protection LED Display

The table below shows battery protection mechanisms and corresponding LED patterns.

Battery Level Indicators for Battery Protection					
LED1	LED2	LED3	LED4	Blinking Pattern	Battery Protection Item
○	☀	○	○	LED2 blinks twice per second	Over current detected
○	☀	○	○	LED2 blinks three times per second	Short circuit detected
○	○	☀	○	LED3 blinks twice per second	Over charge detected
○	○	☀	○	LED3 blinks three times per second	Over-voltage charger detected
○	○	○	☀	LED4 blinks twice per second	Charging temperature is too low (<0°C)
○	○	○	☀	LED4 blinks three times per second	Charging temperature is too high (>40°C)

After any of the above mentioned protection issues are resolved, press the button to turn off the Battery Level Indicator. Unplug the Intelligent Flight Battery from the charger and plug it back in to resume charging. Note that you do not need to unplug and plug the charger in the event of a room temperature error, the charger will resume charging when the temperature falls within the normal range.



DJI does not take any responsibility for damage caused by third-party chargers.



**How to discharge the Intelligent Flight Battery before transport the batteries for long trip:**

Fly the aircraft outdoors until there is low battery power left, or until the battery can no longer be turned on.

### Buzzer Beeping Description

Toggle the buzzer switch to turn on/off the warning sound.

Descriptions	Beeping Pattern
Toggle the buzzer switch to turn it on	Quick beeping
Connect to the Battery Charger	Quick beeping
A battery pair is fully charged	Quick beeping
Four Intelligent Flight Batteries are fully charged	Alternating two short and one long beeps, last for about 1 hour

### Updating the Firmware

DJI will release firmware updates when available. Refer to the official DJI website and follow the instructions below to update the firmware.

1. Download the latest firmware update program from the official DJI website.  
(<http://www.dji.com/inspire-2/info#downloads>)

2. Turn on the Charging Hub, then connect it to a computer using a Micro USB cable.

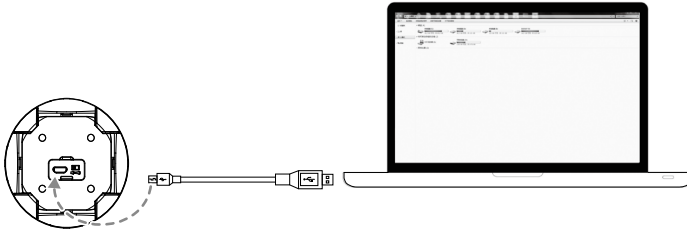

3. Run the firmware update program. Press the update button and wait for the process to finish.
4. The Charging Hub will automatically restart when the update has been successfully completed.
5. Repeat this process if the firmware update fails for any reason.

### Using the Battery

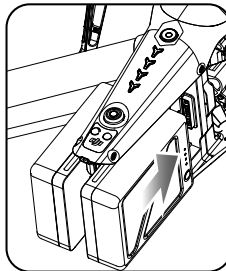

#### Powering ON/OFF

**Powering On:** Press the Power Button once, then press again and hold for 2 seconds to power on.

The Power LED will turn red and the Battery Level Indicators will display the current battery level.

**Powering Off:** Press the Power Button once, then press again and hold for 2 seconds to power off.

#### Heating the Battery

**Manual Heating:** When the battery is powered off, press and hold the power button for 3 seconds to manually initiate battery warmup.

The battery will warm up if the temperature is below 59°F (15°C). As it warms, LED 1 & 2 and LED 3 & 4 will blink alternately. The battery will stop warming when it reaches 68°F (20°C).

The temperature of the battery will remain between 59-68°F (15-20°C) when alternating LED 1 and LED 4 blinking indicates that it is above 59°F (15°C). This will last for approximately 30 minutes then it will power off automatically.

**Auto Heating:** Insert the batteries into the aircraft and power on. When the temperature of the battery is below 59°F (15°C), it will warm up automatically. Check the LEDs for the current power level.



**Low Temperature Notice:**

































1. The performance of the intelligent Flight Battery is significantly reduced when flying in a low temperature environments (those with air temperatures below 5°C). Ensure that the battery is fully charged and the cell voltage is at 4.35 V before each flight.
2. If the DJI GO 4 app displays the “Critical Low Battery Level Warning” when flying in low temperature environments, stop flying and land the aircraft immediately. You will still be able to control the aircraft’s movement when this warning is triggered.
3. In extremely cold weather, the battery temperature may not be high enough even after warming up. In these cases, insulate the battery as required.
4. To ensure optimum performance, keep the Intelligent Flight Battery’s core temperature above 20°C when in use.
5. Battery insulation paste is available for you to use.

**Checking the battery level**

The Battery Level Indicators display how much remaining power the battery has. When the battery is powered off, press the Power Button once. The Battery Level Indicators will light up to display the current battery level. See below for details.

 The Battery Level Indicators will also show the current battery level during discharging. The indicators are defined below.

 : LED is on.       : LED is flashing.  
 : LED is off.

Battery Level				
LED1	LED2	LED3	LED4	Battery Level
				87.5%~100%
				75%~87.5%
				62.5%~75%
				50%~62.5%
				37.5%~50%
				25%~37.5%
				12.5%~25%
				0%~12.5%

# Remote Controllers

---

This chapter describes the features of the remote controller that includes aircraft and remote controller operations and dual remote controller mode.

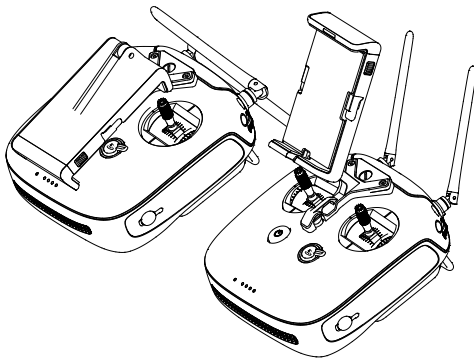

# Remote Controller

## Remote Controller Profile

The Inspire 2 remote controller is a multi-function wireless communication device that integrates a dual frequency video downlink system and the aircraft remote control system. The 5.8 GHz video downlink is recommended for urban areas to resist interference, 2.4 GHz is good for long transmission distances in open areas. The remote controller features a number of camera control functions, including photo/video capture as well as gimbal control. The battery level is displayed via LED indicators on the front panel of the remote controller. When in dual remote controller mode, each of the two remote controllers separately control aircraft and camera and can be up to 328 feet (100m) apart.

- 
- ☰ • **Compliance Version:** The remote controller is compliant with local compliance and regulations.
  - **Operating Mode:** Control can be set to Mode 1 or Mode 2, or to a custom mode.
  - **Mode 1:** The right stick serves as the throttle.
  - **Mode 2:** The left stick serves as the throttle.
- 

- ⚠ Do not operate more than 3 aircrafts within in the same area (size equivalent to a soccer field) to prevent transmission interference.
- 

## Remote Controller Operations

### Powering On And Off The Remote Controller

The Inspire 2 remote controller is powered by a 2S rechargeable battery with a capacity of 6000mAh. The battery level is indicated by the Battery Level LEDs on the front panel. Follow the steps below to power on your remote controller:

1. When powered off, press the Power Button once and the Battery Level LEDs will display the current battery level.
2. Then, press and hold the Power Button to power on the remote controller.
3. The Remote Controller will beep when it powers on. The Status LED will blink green (slave remote controller blinks solid purple) rapidly, indicating that the remote controller is linking to the aircraft. The Status LED will show a solid green light when linking is completed.
4. Repeat step 2 to power off the remote controller after finish using it.

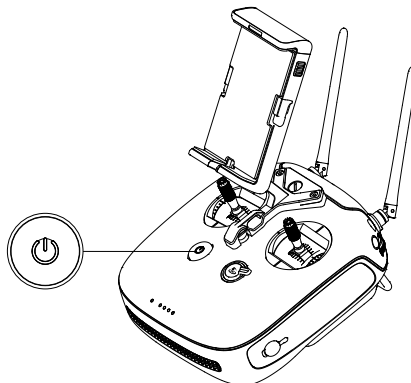

### Charging Remote Controller

Charge the remote controller via supplied charger.

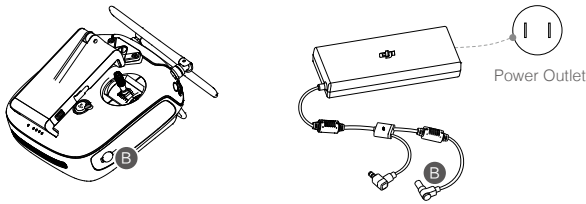

### Controlling Camera

Shoot videos or images and adjust camera settings via the Shutter Button, Camera Settings Dial Video Recording Button and Gimbal Dial on the remote control.

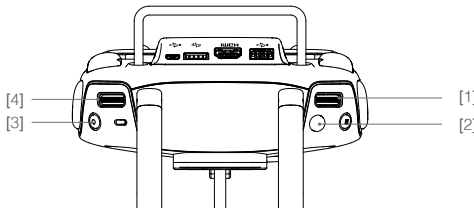

#### [1] Camera Settings Dial

Turn the dial to adjust camera settings such as ISO, shutter speed, and aperture without letting go of the remote controller. Press down on the dial to toggle between these settings.

#### [2] Shutter Button

Press to take a photo. If burst mode is activated, multiple photos will be taken with a continuous press. Press to take a photo even when recording.

#### [3] Video Recording Button



Press once to start recording video, then press again to stop recording.





#### [4] Gimbal Dial

Control the tilt of the gimbal.

### Controlling Aircraft

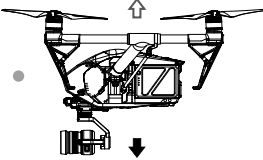
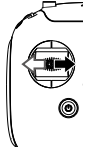
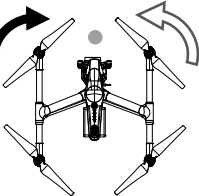
This section explains how to use the various features of the remote controller. The Remote Controller is set to Mode 2 by default.

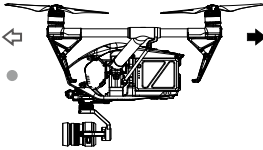
- 
-  Stick Neutral/ mid point: Control sticks of the Remote Controller are placed at the central position.
  -  Move the Stick: The control stick is pushed away from the central position.
-

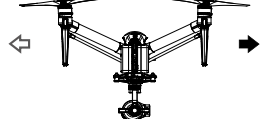
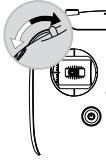
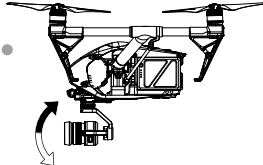
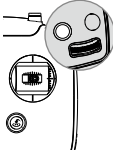
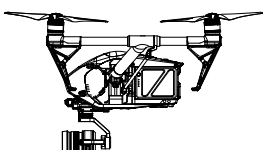
Remote Controller (Mode 2)	Aircraft (● indicates nose direction)	Remarks
		<p>Moving the left stick up and down changes the aircraft's elevation.</p> <p>Push the stick up to ascend and down to descend.</p> <p>Push the throttle stick up to takeoff.</p> <p>When both sticks are centered, the Inspire 2 will hover in place.</p> <p>The more the stick is pushed away from the center position, the faster the Inspire 2 will change elevation. Always push the stick gently to prevent sudden and unexpected elevation changes.</p>
		<p>Moving the left stick to the left or right controls the rudder and rotation of the aircraft.</p> <p>Push the sick left to rotate the aircraft counter clockwise, and push the stick right to rotate the aircraft clockwise. If the stick is centered, the Inspire 2 will stay facing its current direction.</p> <p>The more the stick is pushed away from the center position, the faster the Inspire 2 will rotate.</p>
		<p>Moving the right stick up and down changes the aircraft's forward and backward pitch.</p> <p>Push the stick up to fly forward and down to fly backward. The Inspire 2 will hover in place if the stick is centered.</p> <p>Push the stick further away from the center position for a larger pitch angle and faster flight.</p>
		<p>Moving the right stick control left and right changes the aircraft's left and right pitch.</p> <p>Push left to fly left and right to fly right. The Inspire 2 will hover in place if the stick is centered.</p> <p>Push the stick further away from the center position for a larger pitch angle and faster flight.</p>
		<p>Gimbal Dial: Turn the dial to the right, and the camera will shift to point upwards. Turn the dial to the left, and the camera will shift to point downwards. The camera will remain in its current position when dial is static.</p>
		<p>Press the Intelligent Flight Pause button to pause the current task.</p>

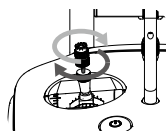

## Adjusting Controller Sticks

Hold and twist the controller sticks clockwise or counter clockwise to adjust the length of the controller sticks. A proper length of controller sticks can improve the controlling accuracy.



## Flight Mode Switch

Toggle the switch to select the desired flight mode. Choose between; P-mode, S-mode and A- mode.

Position	Figure	Flight Mode
Position 1		P-mode
Position 2		S-mode
Position 3		A-mode

Position 1 

Position 2 

Position 3 

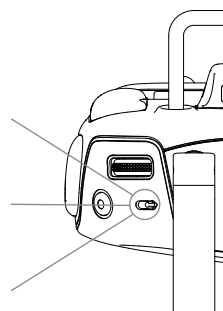

**P-mode (Positioning):** P-mode works best when the GPS signal is strong. The aircraft utilizes GPS, stereo Vision System and Infrared Sensing System to stabilize, avoid obstacles or track moving subjects. Advanced features such as TapFly and ActiveTrack are enabled in this mode.

**S-mode (Sport):** The handling gain values of the aircraft are adjusted to enhance aircraft maneuverability. Note that Obstacle Sensing systems are disabled in this mode.

**A-mode (Attitude):** When neither the GPS nor the Vision System is available, the aircraft will only use its barometer for positioning to control the altitude.

The Flight Mode is locked in P-mode by default, regardless of switch position. To switch flight modes, go to Camera view in the DJI GO 4 app, tap  and enable "Multiple Flight Modes". After enabling multiple flight modes, toggle the switch to P and then to S to fly in Sport Mode.

## Transformation Switch / RTH Button

The Transformation Switch / RTH Button combination serves two functions. Toggle the switch up or down to raise or lower the landing gear. Or, press the button to activate the Return to Home (RTH) procedure. Intelligent landing gear will automatically raise after takeoff and lower when landing. They can also be controlled manually using the Transformation Switch.

### Transformation Switch

This switch has two positions. The effect of toggling the switch to any of these positions is defined below:

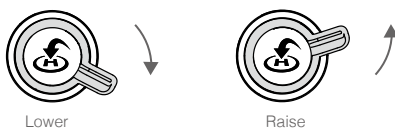

1. **Raise:** Raise the landing gear to its upper most position.

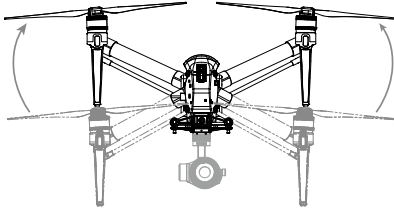

2. **Lower:** The landing gear will lower to its lowest position for landing.

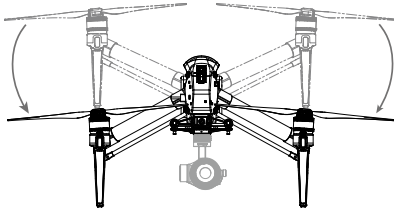

- Do not raise the landing gear when the aircraft is on the ground. Ensure the landing gear is lowered before landing.
- The aircraft will not be able to land if the landing gear does not lower.

### RTH button

Press and hold this button to start the Return to Home (RTH) procedure. The aircraft will then return to the last recorded Home Point. Press this button again to cancel the RTH procedure and regain the control of the aircraft.

Determine RTH status by sound:

Single beep... Request to return, but not receive the respond from the aircraft yet.

Double beep... RTH in progress.

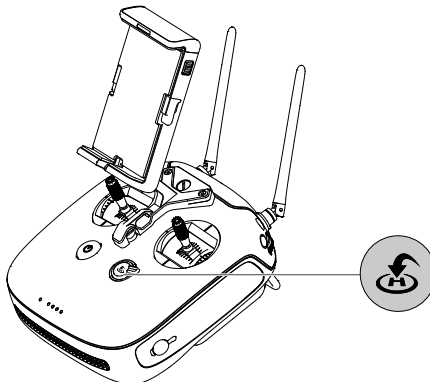

### Connecting Mobile Device

Tilt the Mobile Device Holder to the desired position. Press the button on the side of the Mobile Device Holder to release the clamp, and then place your mobile device into the clamp. Adjust the clamp to secure your mobile device. Then connect your mobile device to the remote controller with a USB cable. Plug one end of the cable into your mobile device, and the other end into the USB port on the back of the remote controller.

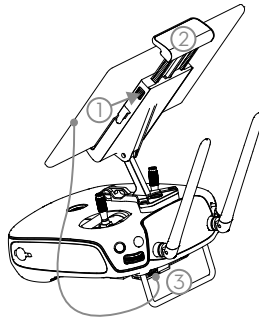

### Optimal Transmission Range

The signal transmission between aircraft and remote controller perform best within the range that displayed in the picture shown below:

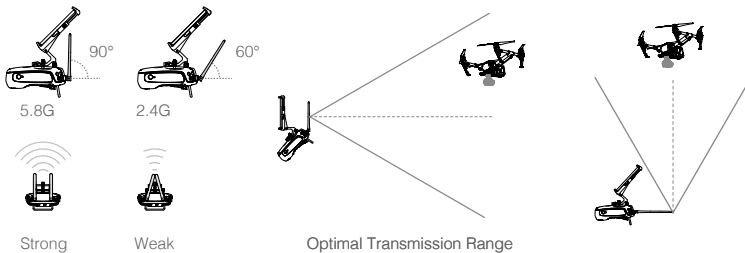

Ensure the aircraft is flying within the optimal transmission range. Adjust the distance and position between the operator and the aircraft to achieve optimal transmission performance. The position of the antennas required for optimal transmission range varies in the frequency of 5.8G and 2.4G. Please place the antennas based on the actual operating frequency.

### Dual Remote Controllers Mode

More than one remote controller can connect to the same aircraft in Dual Remote Controller mode. In Dual Controllers mode, the "Master" remote controller operator controls the orientation of the aircraft, while the "Slave" remote controller controls the movement of the gimbal and camera operation. "Master" and "Slave" remote controllers communicate each other via WiFi.

- ⚠ In Dual Controller Mode, when the Master remote controller is primary, it can control gimbal pitch and pan. When the Slave remote controller is primary, it can control gimbal pitch, pan and roll.
- Dual Remote Controller mode is not available in Russia and Israel.

### Setting Up Dual Remote Controllers Mode

Dual Remote Controllers mode is disabled by default. Users must enable this feature on the “Master” remote controller by through the DJI GO 4 app. Follow the steps below for setup:

#### “Master” Remote Controller:

1. Connect the remote controller to your mobile device and launch the DJI GO 4 app.
2. Go to the Camera page, and tap  to enter the remote controller settings window.
3. Select “Master” set the remote controller as “Master” remote controller.
4. Enter the connection password for the “Slave” remote controller.

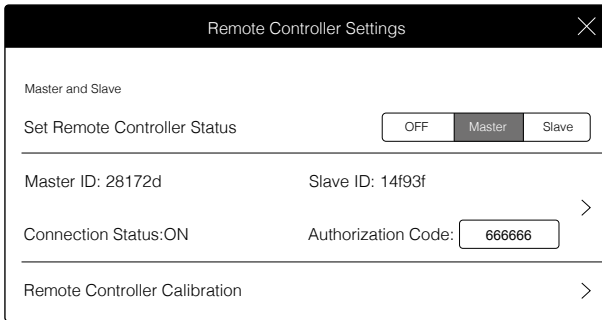

#### “Slave” Remote Controller:

1. Select “Slave” to set the remote controller as “Slave” remote controller.

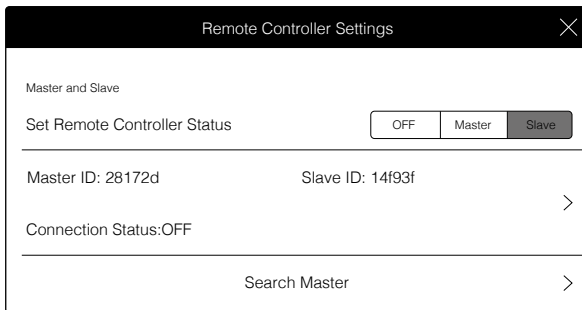

- ⚠ Remote controller cannot link to the aircraft if the remote controller is set as “Slave”. Meanwhile, the “Slave” remote controller cannot control the orientation of the aircraft. Reset the remote controller to “Master” in DJI GO 4 app if you wish to link the remote controller to the aircraft.

2. Search the "Master" remote controller in the surrounding area.

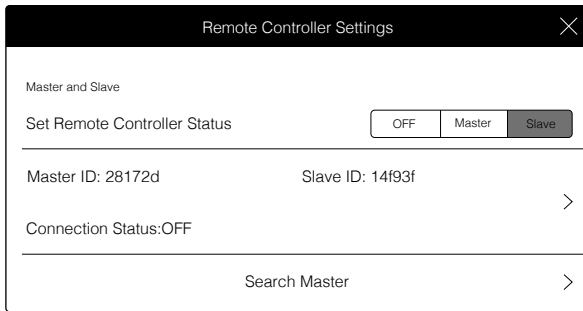



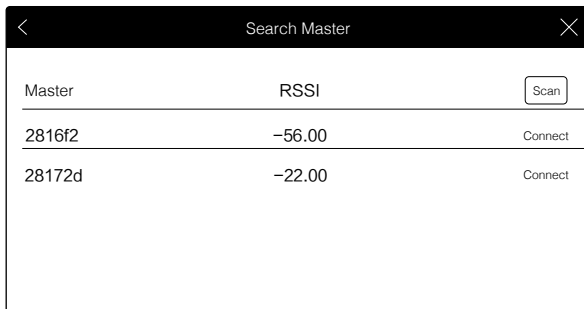





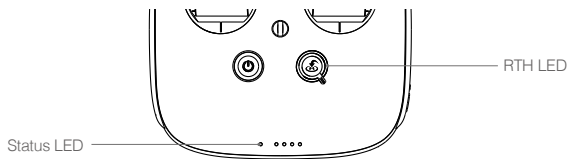



3. Select the "Master" remote controller from the "Master" list and input the connection password to connect to the desired "Master" remote controller.



## Remote Controller Status LED

The Status LED reflects connection status between Remote Controller and aircraft. The RTH LED shows the Return to Home status of the aircraft. The table below contains details on these indicators.



Status LED	Alarm	Remote Controller Status
 — Solid Red	—	The remote controller set as "Master" but it is not connected with the aircraft.
 — Solid Green	—	The remote controller set as "Master" and it is connected with the aircraft.
 — Solid Purple	—	The remote controller set as "Slave" but it is not connected with the aircraft.
 — Solid Blue	—	The remote controller set as "Slave" and it is connected with the aircraft.
 ..... Slow Blinking Red	D-D-D.....	Remote controller error.
 /  ..... Red and Green/ Red and Yellow Alternate Blinks	None	HD Downlink is disrupted.
RTH LED	Sound	Remote Controller Status.
 — Solid White	 chime	Initiate RTH procedure.
 ..... Blinking White	D . . .	Send RTH command to aircraft.
 ..... Blinking White	DD . . . .	Aircraft returning to Home Point.

 The Remote Status Indicator will blink red, sound an alert, when the battery level is critically low.

## Linking the Remote Controller

The remote controller is linked to your aircraft before delivery. Linking is only required when using a new remote controller for the first time. Follow these steps to link a new remote controller:

1. Power on the remote controller and connect to the mobile device. Launch DJI GO 4 app.
2. Power on the Intelligent Flight Battery.
3. Enter camera view and then tap "Linking Remote Controller" button as shown below.

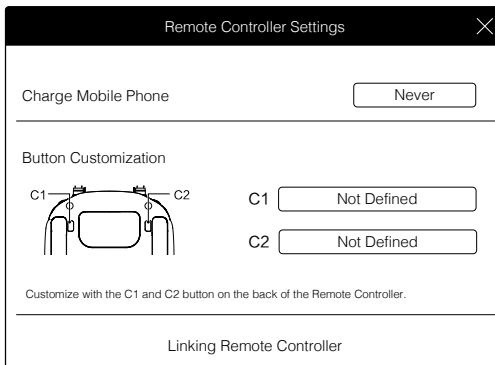

- The remote controller is ready to link. The Remote Controller Status Indicator blinks blue and "beep" sound is emitted.
- Locate the Linking button on the aircraft, as shown in the figure shown below. Press the Linking button to start linking. The Remote Controller Status Indicator will display solid green if Link is succeed.

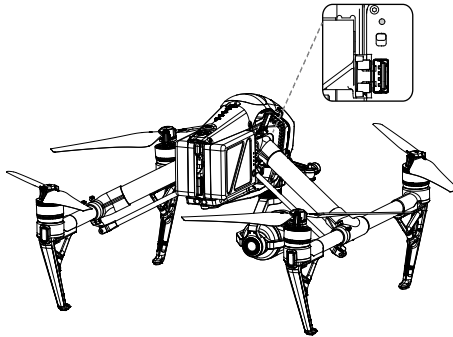

- ⚠ Remote controller cannot link to the aircraft if the remote controller is set as "Slave". Meanwhile, the "Slave" remote controller cannot control the orientation of the aircraft. Reset the remote controller to "Master" in DJI GO 4 app if you wish to link the remote controller to the aircraft.
- Remote controller will disconnect from the linked aircraft if a new remote controller is linked to the same aircraft.
- Press the C1 button, C2 button and Start/Stop button for fast linking.

### Used with the DJI Focus

DJI Focus and DJI Focus Handwheel are fully compatible with the Zenmuse X5S and X4S gimbal and camera. No calibration is required when using the Focus with the gimbal and camera. Use the DJI Focus for example.

#### Connection

To allow communication between the two devices, connect the communication port on the Focus remote controller to the CAN Bus port on the remote controller using the dedicated CAN Bus cable.

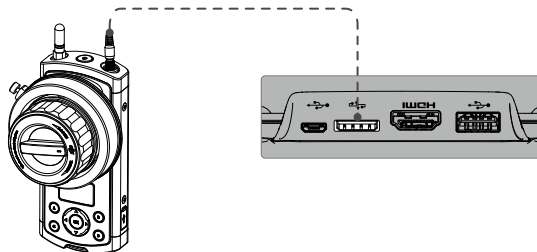

- 💡 Ensure that the gimbal and camera is set in AF mode.
- Refer to "DJI FOCUS User Manual" for more information.

# Gimbal and Camera

---

This chapter provides the technical specifications of the camera and explains the working mode of the gimbal.

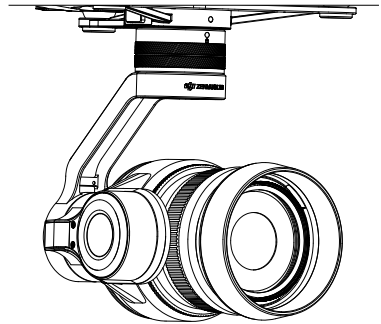

# Camera and Gimbal

## Camera

### Camera Profile

Featuring M4/3 CMOS sensor, the Zenmuse X5S supports up to 20.80 MP still photo capture. It is capable of capturing 5.2K 30fps CinemaDNG video and Apple ProRes Video as well as 4K 60fps using H.264. The Zenmuse X5S is built using the M4/3 interchangeable lens standard. A variety of shooting modes, including single shooting, burst shooting and interval shooting, provide more options of capture. Burst and AEB is available, with up to 14 stills.

When the DJI CINESSD is in use, the Zenmuse X5S is able to record lossless videos with a bitrate of 5.2 Gbps in the CinemaDNG format or capture DNG stills at 20fps continuously.

When mounted on the Inspire 2, the 3-axis gimbal provides a stable platform for the camera to get clear shots even during rapid maneuvering. The gimbal tilts the camera across a  $-130^{\circ}$  to  $+40^{\circ}$  pitch angle and pans  $\pm 320^{\circ}$  in both directions. Live HD video from the camera is streamed to the DJI GO 4 app.

### Camera Micro SD Card Slot

To store your photos and videos, plug in the Micro SD card into the slot shown below before powering on the Inspire 2. The Inspire 2 comes with a 16GB Micro SD card and supports up to a 128GB Micro SD card. A UHS-3 type Micro SD card is recommended, because the fast read and write capability of these cards enables you to store high-resolution video data.

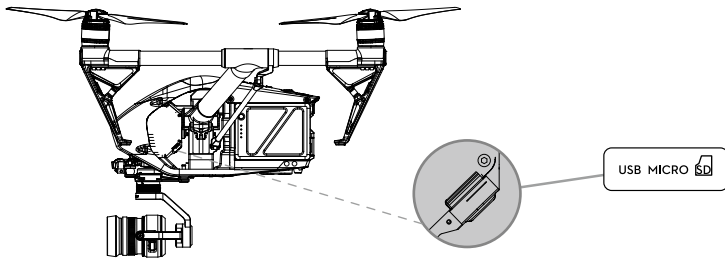

---

**⚠** The Inspire 2 currently supports the following Micro SD cards, and will continue to support more cards in future.

- Sandisk Extreme 32GB UHS-3 MICROSDHC
- Sandisk Extreme 64GB UHS-3 MICROSDXC
- Panasonic 32GB UHS-3 MicroSDHC
- Panasonic 64GB UHS-3 MicroSDXC
- Samsung PRO 32GB UHS-3 MicroSDHC
- Samsung PRO 64GB UHS-3 MicroSDXC
- Samsung PRO 128GB UHS-3 MicroSDXC.

---

**⊘** Do not remove Micro SD card from the Inspire 2 when it is powered on.  
To ensure the stability of the camera system, single video recordings are capped at 30 minutes.

---

## USB Port

Power on the Inspire 2 and then connect a USB cable to the USB port to download photos or videos from the Inspire 2 to your computer.

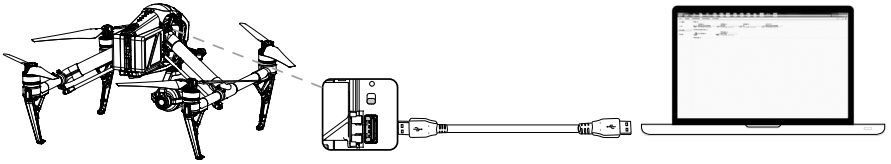

 Power on the aircraft before attempting to download the files.

## Camera Operation

### Remote Controller

Use the Shutter and Record button on the remote controller to shoot the images or the videos. For more information about how to use these buttons, refer to "Controlling Camera".

### DJI GO 4 app

Use the DJI GO 4 app to shoot the images or the videos. For more information, refer to "Zenmuse X5S User Manual".

## Gimbal

### Gimbal Profile

The 3-axis Gimbal provides a steady platform for the attached camera, allowing you to capture stabilized images and video.

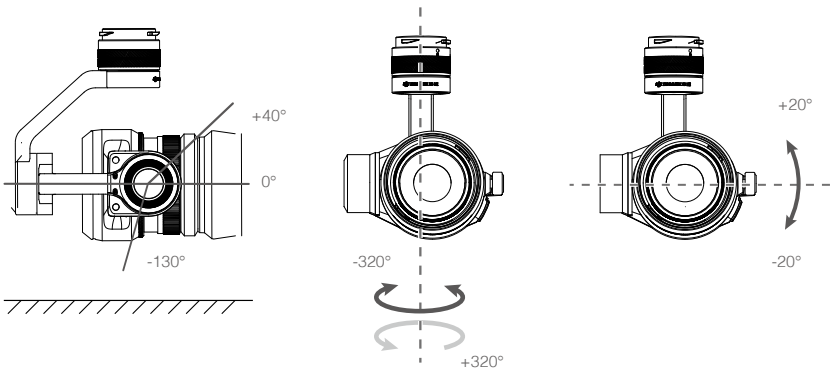

### Using DJI GO 4 App to Control Gimbal

Follow the steps below to use DJI GO 4 app to control the gimbal orientation:

1. Launch DJI GO 4 app, enter camera page.
2. Tap and press on the screen until a blue circle is shown.
3. Slide to control the gimbal orientation within the "Camera" page as shown below.

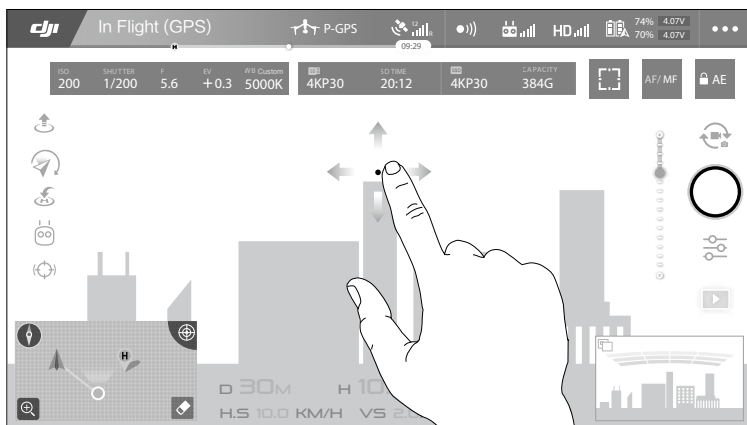

### Gimbal Operation Modes

Three Gimbal operation modes are available. Switch between the different operation modes on the Camera page of the DJI GO 4 App. Note that your mobile device must be connected to the remote controller for changes to take effect. Refer to the table below for details:

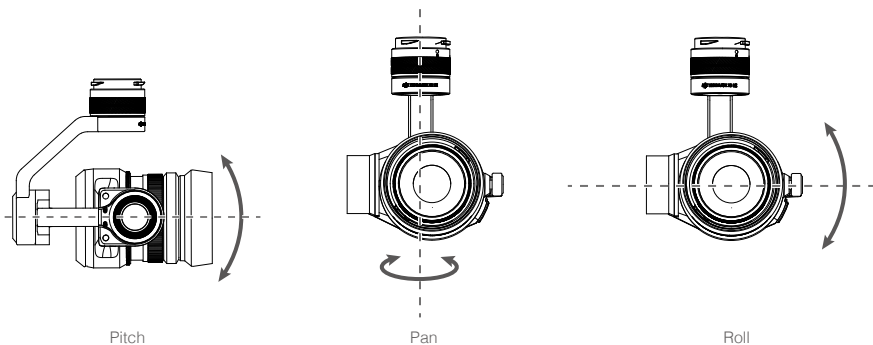

	<b>Follow Mode</b>	Gimbal pan cannot be controlled in this mode.
	<b>Free Mode</b>	The Gimbal's motion is independent of the aircraft's orientation.
	<b>Reset</b>	Tap to force the Gimbal orientation to re-align with aircraft's orientation by panning from gimbal's current orientation. Pitch angle will remain unchanged during the re-alignment.

- ⚠ Gimbal pan cannot be controlled in Follow Mode. In Free Mode, press and hold the C1 Button while rotating the control dial to adjust gimbal yaw.
- The gimbal will be in free mode when the "Slave" remote controller controls the gimbal in Dual Remote Controllers Mode.

## Using CINESSD

Using an Inspire 2 as an example.

### Storing Files

1. Power off the aircraft.
2. Insert the CINESSD into the aircraft. If the CINESSD is not detected, check if it is inserted correctly.

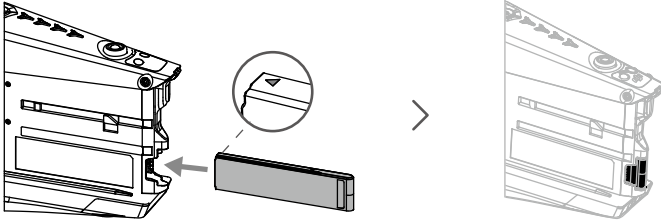

3. Power on the aircraft.
4. Information about the CINESSD will be available in the DJI GO™ 4 app.

### Exporting Files

1. Power off the aircraft. Remove the batteries and then the CINESSD.

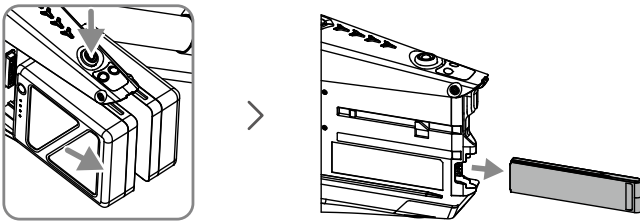

2. Insert the CINESSD into the DJI CINESSD Station, then connect the station to a computer via a USB cable.

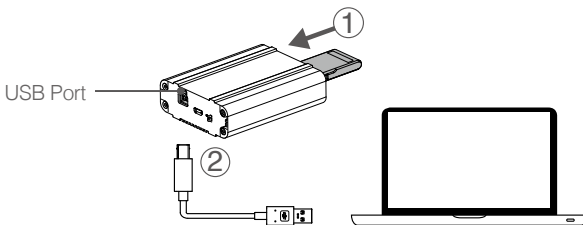

3. When connected, an icon named "DJI\_A" followed by a number sequence will appear. Click to start the file export.
4. Safely remove the station before unplugging it from your computer.

 No additional software is required for exporting data from the CINESSD. You may also use the following DJI software based on your system.

- **Windows:** DJI Camera Exporter.
- **Mac:** DJI CINELIGHT™.

-  • DO NOT remove the CINESSD when it is powered on.
- Insert the CINESSD before connecting the station to the computer.
  - The station icon will vary based on your computer operating system.

### Deleting Files

To guarantee the high performance of the DJI CINESSD, the station only supports file exporting. To delete files, please insert the CINESSD into the aircraft and launch the DJI GO 4 app to format the CINESSD to free up storage space.

-  Ensure to back up your files before formatting the DJI CINESSD.

### Specifications

Capacity	120 GB*/ 240 GB/ 480 GB
Size	105.5 mm×27 mm×7 mm
Weight	42.5 g
Operation Temperature Range	32° to 104° F (0° to 40° C)
Storage Temperature Range	-40° to 185° F (-40° to 85 °C)
Humidity	5% to 95%, non-condensing

\* The 120G CINESSD does not support 5.2K 30fps or 4K 60fps CinemaDNG videos.

## DJI GO 4 App

---

This chapter describes the four main GUI of the DJI GO 4 app.

# DJI GO 4 App

The DJI GO 4 app is a new mobile app designed specifically for the Inspire 2. Use this app to control the gimbal, camera and other features of your flight system. The app also comes with Map, Store a User Center, for configuring your aircraft and sharing your content with friends. It is recommended that you use a tablet for the best experience.

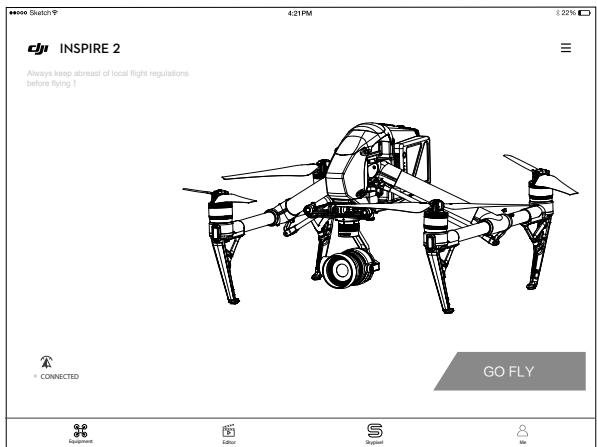

## Camera

The Camera page contains a live HD video feed from the Inspire 2's camera. You can also configure various camera parameters from the Camera page.

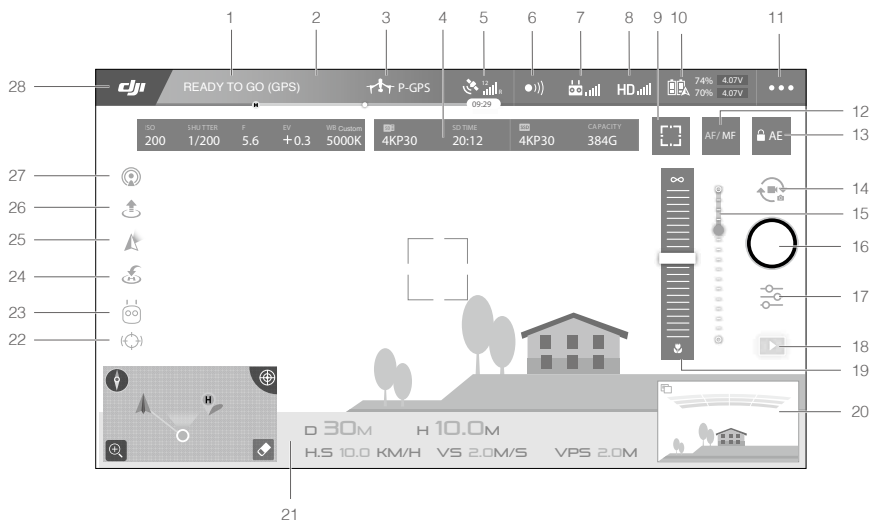

## 1. System Status

: This icon indicates aircraft flight status and various warning messages.

## 2. Battery Level Indicator

: The battery level indicator provides a dynamic display of the battery level. The colored zones on the battery level indicator represent the power levels needed to carry out different functions.

## 3. Flight Mode

: The text next to this icon indicates the current flight mode.

Tap to configure the MC (Main Controller) Settings. These settings allow you to modify flight limits and set gain values.

## 4. Camera Parameters

Displays camera settings parameters and capacity.

ISO	SHUTTER	F	EV	WB Custom	SD TIME	CAPACITY
200	1/200	5.6	+0.3	5000K	4KP30	20:12
					4KP30	384G

(1) Tap  to set the white balance parameters.

(2) Tap  to set the photo and video parameters.

## 5. GPS Signal Strength

: Shows the current GPS signal strength. White bars indicate adequate GPS strength.

## 6. Obstacle Sensing Function Status

: Tap into this button to enable or disable features provided by the Vision System.

## 7. Remote Controller Signal Strength

: This icon shows the strength of the remote controller signal.

## 8. HD Video Link Signal Strength

: This icon shows the strength of the HD video downlink connection between the aircraft and the remote controller.

## 9. Focus/Metering Button

: Tap to switch between focus and metering mode. Tap to select object for focusing or metering.

## 10. Battery Level

: This icon shows the current battery level.

Tap to view the battery information menu, set the various battery warning thresholds, and view the battery warning history.

## 11. General Settings

: Tap to enter general setting menu for setting metrics, enabling livestream, display flight routes and so on.

## 12. AF/MF

: Tap to switch the focus mode.

## 13. Auto Exposure Lock

: Tap to lock the exposure value.

14. Photo/Video Button

 : Tap to switch between photo and video recording modes.

15. Gimbal Slider

 : Displays the pitch of the gimbal.

16. Shoot / Record Button

 : Tap to start shooting photos or recording video.

17. Camera Settings

 : Tap to set ISO, shutter and auto exposure values of the camera.

18. Playback

 : Tap to enter the playback page and preview photos and videos as soon as they are captured.

19. Manual Focus

Only effective in MF mode.

20. FPV

FPV is only available on tablets. Pinch to zoom in or out of the window.



 : Red bars are displayed when obstacles are close to the aircraft. Orange bars are displayed when obstacles are in detection range.

 : Tap to zoom in on the FPV window and move it to the middle of the screen.

21. Flight Telemetry

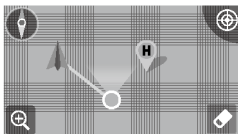

D 30M    H 10.0M  
 H.S 10.0 KM/H    VS 2.0M/S    VPS 2.0M

(1) Tap to switch to the map view.

(2) Flight Attitude and Radar Function:

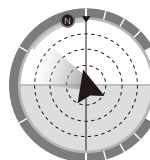

- The red arrow shows which direction the aircraft is facing.
- The ratio of the gray area to the blue area indicates the aircraft's pitch.
- The horizontal level of the gray area indicates the aircraft's roll angle.

- A blue line indicates the current position of the gimbal's tilt motor.
- The outermost grey circle displays the current power capacity.

(3) Flight Parameters:

Altitude: Vertical distance from the Home Point.

Distance: Horizontal distance from the Home Point.

Vertical Speed: Movement speed across a vertical distance.

Horizontal Speed: Movement speed across a horizontal distance.

(4) Aircraft Distance:

The horizontal distance between the aircraft and the operator.

## 22. Spotlight Pro

: Tap to use the Spotlight Pro function.

## 23. Intelligent Flight Mode

: Display the current mode. Tap to select Intelligent Flight Mode.

## 24. Smart RTH

: Initiate RTH home procedure. Tap to have the aircraft return to the last recorded home point.

## 25. Gimbal Working Modes

Follow mode, free mode and reset mode are included.

## 26. Auto Takeoff/Landing

: Tap to initiate auto takeoff or landing.

## 27. Livestream

: This icon indicates the current video feed is being broadcast live on YouTube. Ensure that mobile data service is available on your mobile device.

## 28. Back

: Tap this icon to return to the main menu.

## Editor

An intelligent video editor is built into the DJI GO 4 app. After recording several video clips and downloading them to your mobile device, go to Editor on the home screen. You can then select a template and a specified number of clips which are automatically combined to create a short film that can be shared immediately.

## SkyPixel

Find out about our latest events, featured products and trending Skypixel uploads in the SkyPixel page.

## Me

If you already have a DJI account, you will be able to participate in forum discussions, earn Credits in the DJI Store, and share your artwork with the community.

# Flight

---

This chapter describes the flight safety and flight restrictions.

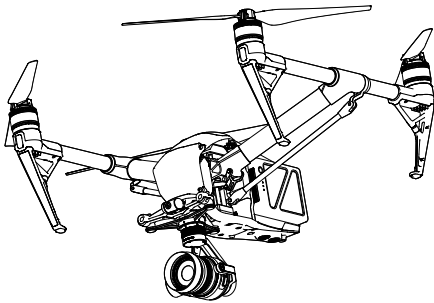

# Flight

Once pre-flight preparation is complete, it is recommended that you use the flight simulator in the DJI GO 4 app to hone your flight skills and practice flying safely. Ensure that all flights are carried out in an open area.

## Flight Environment Requirements

1. Do not use the aircraft in severe weather conditions. These include wind speeds exceeding 10 m/s , snow, rain and fog.
2. Only fly in open areas. Tall structures and large metal structures may affect the accuracy of the on-board compass and GPS system.
3. Avoid obstacles, crowds, high voltage power lines, trees, and bodies of water.
4. Minimize interference by avoiding areas with high levels of electromagnetism, including base stations and radio transmission towers.
5. Aircraft and battery performance is subject to environmental factors such as air density and temperature. Be very careful when flying at high altitudes, as the performance of the battery and aircraft may be affected.
6. The compass and GPS will not work in Polar Regions. The aircraft will auto switch to A-mode and use the Vision System for positioning.

## Flight Limits and No-Fly Zones



All unmanned aerial vehicle (UAV) operators should abide by all regulations set forth by government and regulatory agencies including the ICAO and the FAA. For safety reasons, flights are limited by default, which helps users operate this product safely and legally. Flight limitations include height limits, distance limits, and No-Fly Zones.

When operating in P-mode, height limits, distance limits, and No-Fly Zones function concurrently to manage flight safety. In A-mode, only height limits are in effect, which by default prevent the aircraft altitude from exceeding 1640 feet (500 m) .

### Maximum flight altitude & Radius Limits

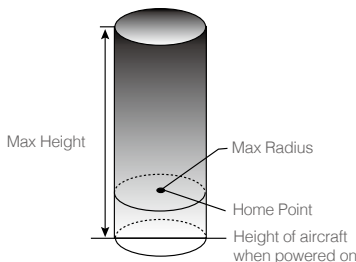
Maximum flight altitude and radius limits may be changed in the DJI GO 4 app. Be aware that the maximum flight altitude cannot exceed 1640 feet (500 meters). In accordance with these settings, your Inspire 2 will fly in a restricted cylinder, as shown below:



GPS Signal Strong  ..... Blinking Green			
	Flight Limits	DJI GO 4 App	Aircraft Status Indicator
Maximum Flight Altitude	Aircraft's altitude cannot exceed the specified value.	Warning: Height limit reached.	None.
Max Radius	Flight distance must be within the max radius.	Warning: Distance limit reached.	Rapid red flashing  ..... when close to the max radius limit.

GPS Signal Weak  ..... Blinking Yellow			
	Flight Limits	DJI GO 4 App	Aircraft Status Indicator
Maximum Flight Altitude	Height is restricted to 26 feet (8 meters) when the GPS signal is weak and Vision Positioning is activated. Height is restricted to 164 feet (50 meters) when the GPS signal is weak and Vision Positioning is inactivated.	Warning: Height limit reached.	None.
Max Radius	No limits		



- If the aircraft flies out of the limit, you can still control the aircraft, but you cannot fly it any farther.
- If the aircraft flies out of the max radius it will fly back within range automatically when GPS signal is strong.

## No-Fly Zones

All No-Fly Zones are listed on the DJI official website at <http://www.dji.com/flysafe/no-fly>. No-Fly Zones are divided into Airports and Restricted Areas. Airports include major airports and flying fields where manned aircraft operate at low altitudes. Restricted Areas include borders between countries or sensitive sites. The details of the No-Fly Zones are explained below:

### Airport:



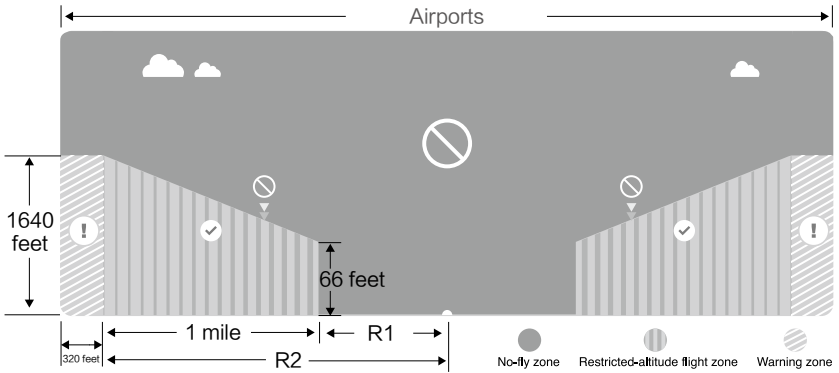



- (1) Airport No-Fly Zone are comprised of Take-off Restricted zones and Restricted Altitude Zones. Each zone features circles of various sizes.
- (2) R1 miles (value of the R1 depends on the size and shape of the airport) around the airport is a Take-off restricted zone, inside of which take off is prevented.
- (3) From R1 mile to R1 + 1 mile around the airport the flight altitude is limited to a 15 degree inclination. Starting at 65 feet (20 meters) from the edge of airport and radiating outward. The flight altitude is limited to 1640 feet (500 meters) at R1+1 mile.
- (4) When the aircraft enters within 320 feet (100 meters) of No-Fly Zones, a warning message will appear on the DJI GO 4 app.

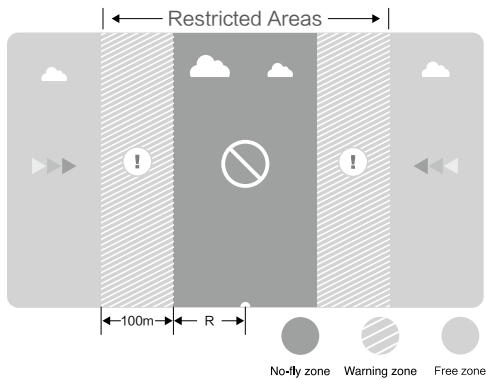



### Restricted Areas:

- (1) Restricted Areas does not have flight altitude restrictions.
- (2) R miles around the designated restriction area is a Take-off Restricted area. Aircraft cannot take off within this zone. The value of R varies based on the definition of the restricted areas.
- (3) A "warning zone" has been set around the Restricted Area. When the aircraft approaches within 0.062 miles (100 m) of this zone, a warning message will appear on the DJI GO 4 app.



GPS Signal Strong  ..... Blinking Green		
Zone	Restriction	Aircraft Status Indicator
No-fly Zone 	Motors will not start.	 ..... Red flashing
	If the aircraft enters the restricted area in A-mode, but is switched to P-mode, the aircraft will automatically descend, land, and stop its motors.	
Restricted-altitude flight zone 	If the aircraft enters the restricted area in A-mode, but is switched to P-mode, it will descend to an appropriate altitude and hover 15 feet below the altitude limit.	
Warning zone 	No flight restriction applies, but there will be a warning .	
Free zone 	No restrictions.	None.

 Semi-automatic descent: All stick commands are available except the left stick command during the descent and landing process. Motors will stop automatically after landing.

-  • When flying in a safety zone, the aircraft's status indicator will blink red rapidly and continue for 3 seconds, then switch to indicate current flying status and continue for 5 seconds at which point it will switch back to blinking red.
- For safety reasons, please do not fly close to airports, highways, railway stations, railway lines, city centers, or other sensitive areas. Fly the aircraft only within your line of sight.

## Preflight Checklist

1. Remote controller, Intelligent Flight Battery, and mobile device are fully charged.
2. Propellers are mounted correctly and firmly.
3. Micro SD card has been inserted, if necessary.
4. Gimbal is functioning normally.
5. Motors can start and are functioning normally.
6. The DJI GO 4 app is successfully connected to the aircraft.
7. Ensure that the sensors for the Obstacle Sensing System are clean.

## Calibrating the Compass

Only calibrate the compass when the DJI GO 4 app or the status indicator prompt you to do so. Observe the following rules when calibrating your compass:

- ☀️ • DO NOT calibrate your compass where there is a chance of strong magnetic interference, such as magnetite, parking structures, and steel reinforcements underground.
- DO NOT carry ferromagnetic materials with you during calibration such as cellular phones.
- The DJI GO 4 app will prompt you to resolve the compass issue if the compass is affected by strong interference after calibration is complete. Follow the prompted instructions to resolve the compass issue.

### Calibration Procedures

Choose an open area to carry out the following procedures.

1. Tap the Aircraft Status Bar in the app and select "Calibrate", then follow the on-screen instructions.
2. Hold the aircraft horizontally and rotate 360 degrees. The Aircraft Status Indicators will display a solid green light.

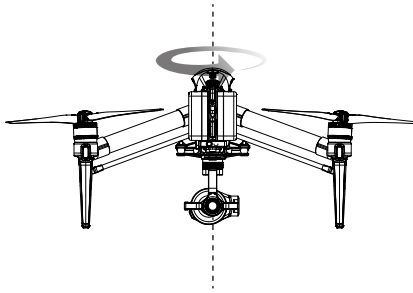

3. Hold the aircraft vertically, with nose pointing downward, and rotate it 360 degrees around the center axis. Recalibrate the compass if the Aircraft Status Indicator glows blinking red.

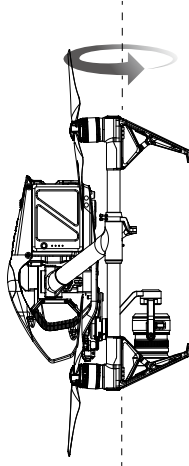

- ⚠ If the Aircraft Status Indicator blinks red and yellow after the calibration procedure, move your aircraft to a different location and try again.

- ☀
- DO NOT calibrate the compass near metal objects such as a metal bridge, cars, scaffolding.
  - If the aircraft status indicators are blinking red and yellow alternately after placing the aircraft on the ground, the compass has detected magnetic interference. Change your location.

## Auto Take-off and Auto Landing

### Auto Takeoff

Use auto takeoff only if the Aircraft Status Indicators are blinking green. Follow the steps below to use the auto takeoff feature:

1. Launch the DJI GO 4 app, and enter "Camera" page.
2. Complete all steps on the pre-flight checklist.
3. Tap "☀", and confirm that conditions are safe for flight. Slide the icon to confirm and takeoff.
4. Aircraft takes off and hovers at (1.2 meters) above ground.

- ⚠ Aircraft Status Indicator blinks rapidly when it is using the Vision System for stabilization. The aircraft will automatically hover below 10 meters. It is recommended to wait until there is sufficient GPS lock before using the Auto Take-off feature.

### Auto-Landing

Use auto-landing only if the Aircraft Status Indicator is blinking green. Follow the steps below to use the auto-landing feature:

1. Tap on "☘", to ensure the landing condition is ideal. Slide to confirm.
2. Abort landing process immediately by using the "⊗" button on the screen.
3. a. When Landing Protection determines that the ground is suitable for landing, the Inspire 2 will land gently.
  - b. If Landing Protection determines that the ground is not suitable for landing, the Inspire 2 will hover and wait for pilot confirmation.
  - c. If Landing Protection is not operational, the DJI GO 4 app will display a landing prompt when the Inspire 2 descends below 0.7 meters. Pull down on the throttle or use the auto landing slider to land.
4. Aircraft will land and turn off automatically.

## Starting/Stopping the Motors

### Starting Motors

A Combination Stick Command (CSC) is used to start the motors. Push both sticks to the bottom inner or outer corners to start the motors. Once the motors have started spinning, release both sticks simultaneously.



## Stopping the Motors

There are two methods to stop the motors.

Method 1: When Inspire 2 has landed, push the left stick down ①, then conduct the same CSC that was used to start the motors, as described above ②. Motors will stop immediately. Release both sticks once motors stop.

Method 2: When the aircraft has landed, push and hold the left stick down. The motors will stop after three seconds.

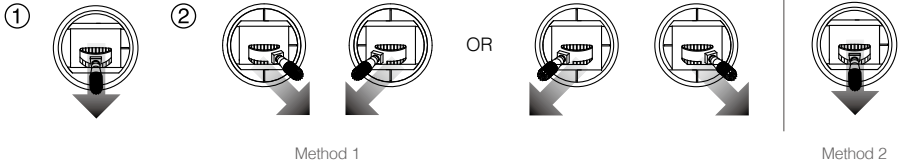

**⚠** Do not perform CSC when aircraft is in midair, otherwise the motors will be stopped.

## Stop the Motor Mid-flight

Pull the left stick to the bottom inside corners and press the RTH button at the same time. **Only stop the motors mid-flight in emergency situations when doing so can reduce the risk of damage or injury.**

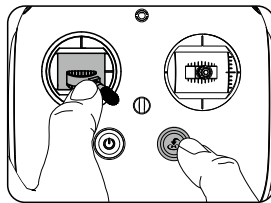

**⚠** Please check that CSC is activated inside DJI GO 4 app, then the user can stop the aircraft mid-air.

## Flight Test

### Takeoff/Landing Procedures

1. Place the aircraft in an open, flat area with the battery level indicators facing towards you.
2. Turn on the remote controller and your mobile device, then turn on the Intelligent Flight Battery.
3. Launch the DJI GO 4 app and enter the Camera page.
4. Wait until the Aircraft Indicators blink green. This means the Home Point is recorded and it is now safe to fly. If they flash yellow, the Home Point has not been recorded.
5. Push the left stick up slowly to take off or use Auto Takeoff.
6. Shoot photos and videos using the DJI GO 4 app.
7. To land, hover over a level surface and gently pull down on the left stick to descend.
8. After landing, execute the CSC command or hold the left stick at its lowest position until the motors stop.
9. Turn off the Intelligent Flight Battery first, then the Remote Controller.



- When the Aircraft Status Indicators blink yellow rapidly during flight, the aircraft has entered Failsafe mode.
  - A low battery level warning is indicated by the Aircraft Status Indicators blinking red slowly or rapidly during flight.
  - Watch our video tutorials for more flight information.
- 

### Video Suggestions and Tips

1. Go through the full pre-flight checklist before each flight.
2. Select the desired gimbal operation mode in the DJI GO 4 app.
3. Only shoot video when flying in P-mode.
4. Always fly in good weather and avoid flying in rain or heavy wind.
5. Choose the camera settings that suit your needs. Settings include photo format and exposure compensation.
6. Perform flight tests to establish flight routes and preview scenes.
7. Push the control sticks gently to keep the aircraft's movement smooth and stable.

# Appendix

---

# Appendix

## Specifications

Aircraft	
Model	T650
Weight	7.25 lbs (3290 g, including two batteries, without gimbal and camera)
Max Takeoff Weight	4000 g
GPS Hovering Accuracy	Vertical: $\pm 1.64$ feet (0.5 m) or $\pm 0.33$ feet (0.1 m, Downward Vision System enabled) Horizontal: $\pm 4.92$ feet (1.5 m) or $\pm 0.98$ feet (0.3 m, Downward Vision System enabled)
Max Angular Velocity	Pitch: 300°/s Yaw: 150°/s
Max Tilt Angle	P-mode: 35° (Forward Vision System enabled: 25°); A-mode: 35°; S-mode: 40°
Max Ascent Speed	P-mode/A-mode: 16.4 ft/s (5 m/s); S-mode: 19.7 ft/s (6 m/s)
Max Descent Speed	Vertical: 13.1 ft/s (4 m/s); Tilt: 13.1-29.5 ft/s (4-9 m/s)
Max Takeoff Sea Level	1.55 mi (2500 m); 3.1 mi (5000 m with specially-designed propeller)
Max Wind Speed Resistance	10 m/s
Max Flight Time	Approx. 25 min (with Zenmuse X5S)
Motor Model	DJI 3512
Propeller Model	DJI 1550T
Indoor Hovering	Enabled by default
Operating Temperature	-4° to 104° F (-20° to 40° C)
Diagonal Distance (propeller excluded)	23.8 inch (605 mm, Landing Mode)
Max Speed	58 mph (94 kph)
Gimbal and Camera (Optional, take the Zenmuse X5S for example)	
General	
Name	Zenmuse X5S
Dimensions	140x98x132 mm
Weight	Approx. 461 g (Including original lens, balancing ring, lens hood)
Camera	
Supported Lens	DJI MFT 15mm/1.7 ASPH (With Balancing Ring and Lens Hood) Panasonic Lumix 15mm/1.7 (With Balancing Ring and Lens Hood) Panasonic Lumix 14-42mm/3.5-5.6 HD (With Balancing Ring) Olympus M.Zuiko 12mm/2.0 (With Balancing Ring) Olympus M.Zuiko 17mm/1.8 (With Balancing Ring) Olympus M.Zuiko 25mm/1.8 (With Balancing Ring) Olympus M.Zuiko 45mm/1.8 (With Balancing Ring) Olympus M.Zuiko 9-18mm/4.0-5.6 (With Balancing Ring)
Sensors	CMOS, 4/3" Effective Pixels: 20.8MP





FOV	72° (with DJI MFT 15mm/1.7 ASPH )
Photo Resolutions	4:3, 5280×3956 16:9, 5280×2970
Video Resolutions	H.264 C4K: 4096×2160 23.976/24/25/29.97/47.95/50/59.94p @100Mbps 4K: 3840×2160 23.976/24/25/29.97/47.95/50/59.94p @100Mbps 3840×1572 23.976/24/25/29.97p @100Mbps 2.7K: 2720×1530 23.976/24/25/29.97p @80Mbps 47.95/50/59.94p @100Mbps FHD: 1920×1080 23.976/24/25/29.97p @60Mbps 47.95/50/59.94p @80Mbps 119.88p @100Mbps H.265 C4K: 4096×2160 23.976/24/25/29.97p @100Mbps 4K: 3840×2160, 3840×1572 23.976/24/25/29.97p @100Mbps 2.7K: 2720×1530 23.976/24/25/29.97p @65Mbps 47.95/50/59.94p @80Mbps FHD: 1920×1080 23.976/24/25/29.97p @50Mbps 47.95/50/59.94p @65Mbps 119.88p @100Mbps C-DNG RAW 5.2K: 5280×2972 23.976/24/25/29.97p, up to 4.2Gbps 4K: 4096×2160, 3840×2160 23.976/24/25/29.97p, up to 2.4Gbps 4K: 4096×2160, 3840×2160 50/59.94p, up to 4.0Gbps ProRes 5.2K: 5280×2160 23.976/24/25/29.97p, 422 HQ @1.3Gbps 4K: 3840×2160 23.976/24/25/29.97p, 422 HQ @900Mbps 4K: 3840×2160 23.976/24/25/29.97p, 4444 XQ @2.0Gbps
Photo Formats	SSD: DNG Micro SD: DNG, JPEG, DNG+JPEG
Video Formats	SSD: CinemaDNG, ProRes Micro SD: MOV, MP4
Operation Modes	Capture, Record, Playback
Still Photography Modes	Micro SD: Single shot, Burst shooting (3/5/7/10/14 frames), Auto Exposure Bracketing (3/5 bracketed frames at 0.7EV bias), Interval SSD: RAW BURST (3/5/7/10/14/∞ frames)
Exposure Mode	Auto, Manual, Shutter Priority, Aperture Priority
Exposure Compensation	±3.0 (1/3 increments)
Metering Mode	Center-weighted metering, Spot metering (area option 12×8)
AE Lock	Supported
Electronic Shutter Speed	8-1/8000s
White Balance	Auto, Sunny, Cloudy, Incandescent, Neon Custom (2000K–10000K)
ISO Range	100 – 6400 (Video) 100 – 25600 (Stills)
Video Captions	Supported

Anti-Flicker	Auto, 50Hz, 60Hz
PAL/NTSC	Supported
<b>Environmental</b>	
Operating Temperature	14° to 104°F (-10 to 40°C)
Storage Temperature	-4° to 140° F (-20 to 60 °C)
<b>Gimbal</b>	
Angular Vibration Range	±0.01°
Controllable Range	Pitch: -130° to +40°; Roll: ±20°; Pan: ±320°
Max Controllable Speed	Pitch: 180°/s; Roll: 180°/s; Pan: 270°/s
Interface Type	DGC2.0
Mechanical Range	Pitch: -140° to +50°; Roll: -50° to +90°; Pan: ±330°
<b>Remote Controller</b>	
Model	GL6D10A
Operating Frequency	2.400-2.483 GHz; 5.725-5.825 GHz
Max Transmitting Distance	2.4 GHz: 4.3 miles (7 km, FCC); 2.2 miles (3.5 km, CE); 2.5 miles (4 km, SRRC) 5.8 GHz: 4.3 miles (7 km, FCC); 1.2 miles (2 km, CE); 3.1 miles (5 km, SRRC)
EIRP	2.4 GHz: 26 dBm (FCC); 17 dBm (CE); 20 dBm (SRRC) 5.8 GHz: 28 dBm (FCC); 14 dBm (CE); 20 dBm (SRRC)
Video Output Ports	USB, HDMI
Power Supply	Built-in battery
Charging	DJI charger
Dual User Capability	Host-and-Slave connection
Mobile Device Holder	Tablet or Smart Phone
Max Mobile Device Width	170 mm
Output Power	9W (Without supplying power to smart device)
Operating Temperature	-4° to 104° F (-20° to 40° C)
Storage Temperature	Less than 3 months: -4° to 113° F (-20° to 45° C) More than 3 months: 72° to 82° F (22° to 28° C)
Charging Temperature	32° to 104° F (0° to 40° C)
Battery	6000 mAh 2S LiPo
USB Supply Power	iOS: 1 A @ 5.2 V (Max); Android: 1.5 A @ 5.2 V (Max)
<b>Charger</b>	
Model	IN2C180
Voltage	26.1 V
Rated Power	180 W
<b>Battery (Standard)</b>	
Name	Intelligent Flight Battery
Model	TB50-4280mAh-22.8V
Capacity	4280 mAh







Voltage	22.8 V
Battery Type	6S LiPo
Energy	97.58 Wh
Net Weight	515 g
Operating Temperature	-4° to 104° F (-20° to 40° C)
Storage Temperature	Less than 3 months: -4° to 113° F (-20° to 45° C) More than 3 months: 72° to 82° F (22° to 28° C)
Charging Temperature	41° to 104° F (5° to 40° C)
Max Charging Power	180 W
<b>Charging Hub (Model: IN2CH)</b>	
Input Voltage	26.1 V
Input Current	6.9 A
<b>Downward Vision System</b>	
Velocity Range	<32.8 ft/s (10 m/s) at height of 6.56 feet (2 m)
Altitude Range	<32.8 feet (10 m)
Operating Range	<32.8 feet (10 m)
Operating Environment	Surfaces with clear patterns and adequate lighting (> 15 lux)
Ultrasonic Sensor Operating Range	0.33-16.4 feet (10-500 cm)
Ultrasonic Sensor Operating Environment	Non-absorbing material, rigid surface (thick indoor carpeting will reduce performance)
<b>Forward Vision System</b>	
Obstacle Sensing Range	2.3-98.4 feet (0.7-30 m)
FOV	Horizontal: 60°; Vertical: 54°
Operating Environment	Surfaces with clear patterns and adequate lighting (> 15 lux)
<b>Upward Infrared Sensing System</b>	
Obstacle Sensing Range	0-16.4 feet (0-5 m)
FOV	±5°
Operating Environment	Large, diffuse and reflective obstacles (reflectivity >10%)

## Aircraft Status Indicator Description

### Normal

	Red, Green and Yellow Flash Alternatively	Power on and self-check
	Green and Yellow Flash Alternatively	Aircraft warming up
	Green Flashes Slowly	Safe to Fly (P mode with GPS and Vision System)
	Green Flashes Twice	Safe to Fly (P mode with Vision System but without GPS)
	Yellow Flashes Slowly	Safe to Fly (A mode but No GPS and Vision System)

**Warning**

 ..... Fast Yellow Flashing	Remote Controller Signal Lost
 ..... Slow Red Flashing	Low Battery Warning
 ..... Fast Red Flashing	Critical Low Battery Warning
 ..... Red Flashing Alternatively	IMU Error
 — Solid Red	Critical Error
  ..... Red and Yellow Flash Alternatively	Compass Calibration Required

**Upgrading the Firmware**

Use DJI Assistant 2 or the DJI GO 4 app to upgrade aircraft and Remote Controller.

**Upgrading the Aircraft Firmware**

**Method 1: Using the DJI Assistant 2**

1. Power on the Intelligent Flight Battery, and toggle the USB Mode Switch down.
2. Connect the Inspire 2 and the PC via the USB cable (with Double A ports).
3. Launch DJI Assistant 2 and login with a DJI account.
4. Click Inspire 2 and the firmware update button.
5. Select the firmware version required.
6. DJI Assistant 2 will download and upgrade the firmware automatically.
7. Restart the aircraft after the firmware upgrade is complete.

**Method 2: Using the DJI GO 4 App**

1. Power on the Intelligent Flight Battery, and toggle the USB Mode Switch up.
2. Connect the aircraft and your mobile device via an appropriate USB cable.
3. Follow the on-screen instructions in the DJI GO 4 app to upgrade. Ensure to connect to the Internet when downloading the firmware.
4. Restart the aircraft after the firmware update is complete.



- During update, the aircraft start a quick single beep continuously. Then the warning sound will alternate between a longer beep and a quick double beep once the update is complete. Restart the aircraft after the firmware update is complete.
- If the warning sound turns into a long beep, retry the update.
- The battery level should be above 30% for the firmware update process.
- When using the DJI GO 4 app to update, you may disconnect the aircraft and the mobile device once the update is more than 30% completed. No Internet connection is required.

## Upgrading the Remote Controller Firmware

### Method 1: Using the DJI GO 4 App

Power on the remote controller and connect it with the DJI GO 4 app. A prompt will appear if a new firmware upgrade is available. To start upgrading, connect a mobile device to the Internet and follow the on-screen instructions.

---



- The firmware update will take around 15 minutes. It is normal that the gimbal will go limp, the aircraft status indicator blinks abnormally and the aircraft reboots. Wait patiently until the update is complete.
  - Ensure the computer has access to the Internet.
  - Ensure the battery level is adequate for the remote controller.
  - Do not disconnect the aircraft from the computer during firmware upgrade.
-

## Compliance Information

### FCC Compliance Notice

This device complies with Part 15 of the FCC Rules. Operation is subject to the following two conditions: (1) This device may not cause harmful interference, and (2) This device must accept any interference received, including interference that may cause undesired operation.

Any changes or modifications not expressly approved by the party responsible for compliance could void the user's authority to operate the equipment.

This equipment has been tested and found to comply with the limits for a Class B digital device, pursuant to part 15 of the FCC Rules. These limits are designed to provide reasonable protection against harmful interference in a residential installation. This equipment generates, uses and can radiate radio frequency energy and, if not installed and used in accordance with the instructions, may cause harmful interference to radio communications. However, there is no guarantee that interference will not occur in a particular installation. If this equipment does cause harmful interference to radio or television reception, which can be determined by turning the equipment off and on, the user is encouraged to try to correct the interference by one or more of the following measures:

- Reorient or relocate the receiving antenna.
- Increase the separation between the equipment and receiver.
- Connect the equipment into an outlet on a circuit different from that to which the receiver is connected.
- Consult the dealer or an experienced radio/TV technician for help.

### RF Exposure Information

This equipment complies with FCC radiation exposure limits set forth for an uncontrolled environment. In order to avoid the possibility of exceeding the FCC radio frequency exposure limits, human proximity to the antenna shall not be less than 20cm during normal operation.

### IC Radiation Exposure Statement:

This equipment complies with IC RF radiation exposure limits set forth for an uncontrolled environment. This transmitter must not be co-located or operating in conjunction with any other antenna or transmitter.

This equipment should be installed and operated with minimum distance 20cm between the radiator & your body.

Any Changes or modifications not expressly approved by the party responsible for compliance could void the user's authority to operate the equipment.

### KCC Warning Message

“해당 무선설비는 운용 중 전파혼신 가능성이 있으므로 인명안전과 관련된 서비스는 할 수 없습니다.”  
“해당 무선설비는 운용 중 전파혼신 가능성이 있음”

### NCC Warning Message

低功率電波輻射性電機管理辦法

第十二條 經型式認證合格之低功率射頻電機，非經許可，公司、商號或使用者均不得擅自變更頻率、加大功率或變更原設計之特性及功能。

第十四條 低功率射頻電機之使用不得影響飛航安全及干擾合法通信；經發現有干擾現象時，應改善至無干擾時方得繼續使用。前項合法通信，指依電信法規定作業之無線電通信。低功率射頻電機須忍受合法通信或工業、科學及醫療用電波輻射性電機設備之干擾。

EU Compliance Statement: SZ DJI TECHNOLOGY CO., LTD. hereby declares that this device is in compliance with the essential requirements and other relevant provisions of the Directive 1999/5/EC.

A copy of the EU Declaration of Conformity is available online at [www.dji.com/euro-compliance](http://www.dji.com/euro-compliance)

Declaración de cumplimiento UE: SZ DJI TECHNOLOGY CO., LTD. por la presente declara que este dispositivo cumple los requisitos básicos y el resto de provisiones relevantes de la Directiva 1999/5/EC.

Hay disponible online una copia de la Declaración de conformidad UE en [www.dji.com/euro-compliance](http://www.dji.com/euro-compliance)

EU-verklaring van overeenstemming: SZ DJI TECHNOLOGY CO., LTD. verklaart hierbij dat dit apparaat voldoet aan de essentiële vereisten en andere relevante bepalingen van Richtlijn 1999/5/EC.

De EU-verklaring van overeenstemming is online beschikbaar op [www.dji.com/euro-compliance](http://www.dji.com/euro-compliance)

Declaração de conformidade da UE: A SZ DJI TECHNOLOGY CO., LTD. declara, através deste documento, que este dispositivo está em conformidade com os requisitos essenciais e outras disposições relevantes da Diretiva 1999/5/EC.

Existe uma cópia da Declaração de conformidade da UE disponível online em [www.dji.com/euro-compliance](http://www.dji.com/euro-compliance)

Dichiarazione di conformità UE: SZ DJI TECHNOLOGY CO., LTD. dichiara che il presente dispositivo è conforme ai requisiti essenziali e alle altre disposizioni rilevanti della direttiva 1999/5/EC.

Una copia della dichiarazione di conformità UE è disponibile online all'indirizzo Web [www.dji.com/euro-compliance](http://www.dji.com/euro-compliance)

Déclaration de conformité UE : Par la présente, SZ DJI TECHNOLOGY CO., LTD déclare que cet appareil est conforme aux principales exigences et autres clauses pertinentes de la directive européenne 1999/5/EC.

Une copie de la déclaration de conformité UE est disponible sur le site [www.dji.com/euro-compliance](http://www.dji.com/euro-compliance)

EU-Compliance: Hiermit erklärt SZ DJI TECHNOLOGY CO., LTD., dass dieses Gerät den wesentlichen Anforderungen und anderen einschlägigen Bestimmungen der EU-Richtlinie 1999/5/EC entspricht.

Eine Kopie der EU-Konformitätserklärung finden Sie online auf [www.dji.com/euro-compliance](http://www.dji.com/euro-compliance).

# CE 1313

EU contact address: DJI GmbH, Industrie Strasse. 12, 97618, Niederlauer, Germany

CAUTION: RISK OF EXPLOSION IF BATTERY IS REPLACED BY AN INCORRECT TYPE. DISPOSE OF USED BATTERIES ACCORDING TO THE INSTRUCTIONS

### Environmentally friendly disposal

Old electrical appliances must not be disposed of together with the residual waste, but have to be disposed of separately. The disposal at the communal collecting point via private persons is for free. The owner of old appliances is responsible to bring the appliances to these collecting points or to similar collection points. With this little personal effort, you contribute to recycle valuable raw materials and the treatment of toxic substances.

### Mexico Warning message

“La operación de este equipo está sujeta a las siguientes dos condiciones: (1) es posible que este equipo o dispositivo no cause interferencia perjudicial y (2) este equipo o dispositivo debe aceptar cualquier interferencia, incluyendo la que pueda causar su operación no deseada.”

### Thailand Warning message

เครื่องโทรทัศน์และอุปกรณ์นี้ มีความสอดคล้องตามข้อกำหนดของ กทช.

## After-Sales Information

Visit the following pages to learn more about After-sales policy and warranty information:

1. After-sales Policy: <http://www.dji.com/service>
2. Refund Policy: <http://www.dji.com/service/refund-return>
3. Paid Repair Service: <http://www.dji.com/service/repair-service>
4. Warranty Service: <http://www.dji.com/service/warranty-service>

This content is subject to change.

Download the latest version from  
[www.dji.com/inspire-2](http://www.dji.com/inspire-2)

If you have any questions about this document, please contact DJI by sending a message to [DocSupport@dji.com](mailto:DocSupport@dji.com).

© 2016 DJI All Rights Reserved.

