

INSTALLATION & OPERATION MANUAL

DECORATIVE VENTED

GAS FIREPLACE LOG

TIERED DUAL BURNER LOG SET



**Models: BRO18NG, BRO24NG - CSO24NG, CSO30NG
MO18DBNG, MO24DBNG - SH18NG, SH24NG**

Burner set for use with all styles and sizes of SureHeat Dual Burner Natural Gas Log Sets.

WARNING: If the information in this manual is not followed exactly, a fire or explosion may result causing property damage, personal injury or loss of life.

- Do not store or use gasoline or other flammable vapors and liquids in the vicinity of this or any other appliance.
- WHAT TO DO IF YOU SMELL GAS
 - Do not try to light any appliance.
 - Do not touch any electrical switch; do not use any phone in your building.
 - Immediately call your gas supplier from a neighbor's phone. Follow the gas supplier's instructions.
 - If you cannot reach your gas supplier, call the fire department.
- Installation and service must be performed by a qualified installer, service agency or the gas supplier.

INSTALLER: Leave this manual with the appliance.

CONSUMER: Retain this manual for future reference.

DUAL BURNER PART LIST

Figure 1



1-6

GRANULES
(HEAVY WEIGHT BAG)

GLOWING EMBERS
(LIGHT WEIGHT BAG)



16



17

NUMBER OF LOGS ARE DETERMINED BY
THE SIZE AND MODEL CHOSEN SETS
RANGE FROM 4 TO 9 LOGS

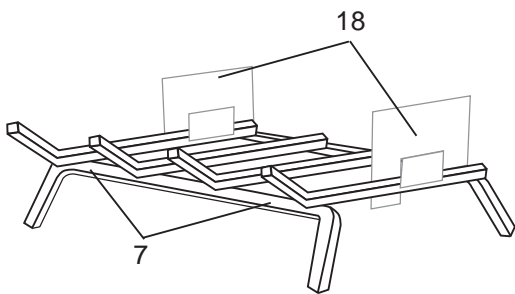

18

7



19



20

LEFT SIDE
KNOCKOUT
PLUG

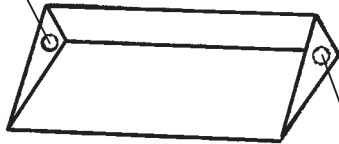

8

RIGHT SIDE
KNOCKOUT
PLUG



9

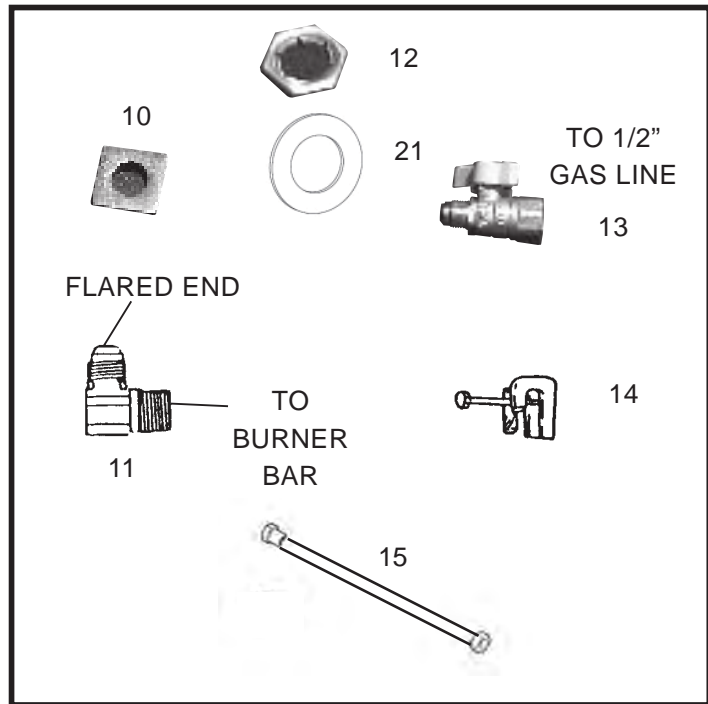

12

10

21

TO 1/2"
GAS LINE

13

FLARED END

TO
BURNER
BAR

11

14

15

REF.	DUAL BURNER Z21.84	PART NUMBER	QTY	PART NUMBER	QTY	PART NUMBER	QTY
		18" SET		24" SET		30" SET	
1-6	LOGS		1		1		1
7	GRATE	WIP-200-90556	1	WIP-200-90566	1	WIP-200-90680	1
8	BURNER PAN	WIP-200-90502	1	WIP-200-90504	1	WIP-200-90506	1
9	DUAL BUNER BAR	WIP-190-90521	1	WIP-190-90523	1	WIP-190-90525	1
10	3/4 BURNER SUPPORT SPACER	RMH-120-00420	1	RMH-120-00420	1	RMH-120-00420	1
11	3/8 BRASS ORIFICE ELBOW	WIP-120-00350	1	WIP-120-00350	1	WIP-120-00350	1
12	3/8" LOCKNUT	RMH-120-00963	1	RMH-120-00963	1	RMH-120-00963	1
13	VALVE	RCODZ00137A	1	RCODZ00137A	1	RCODZ00137A	1
14	DAMPER STOP CLAMP	RMH-120-00100	1	RMH-120-00100	1	RMH-120-00100	1
15	3/8" FLARED TUBING	WIP-120-90426	1	WIP-120-90426	1	WIP-120-90426	1
16	GRANULES	WIP-130-00010	1	WIP-130-00010	1	WIP-130-00010	2
17	GLOWING EMBERS	WIP-130-00300	1	WIP-130-00300	1	WIP-130-00300	2
18	BACK LOG STANDOFFS	WIP-190-90560	2	WIP-190-90560	2	WIP-190-90560	2
19	TAPE SEALANT	RMH-120-00180	1	RMH-120-00180	1	RMH-120-00180	1
20	INSTRUCTION MANUAL	RMH-130-00588	1	RMH-130-00588	1	RMH-130-00588	1
21	WASHER	RCODZ00145A	1	RCOPZ00007A	1	RCOPZ00007A	1

WARNING: Improper use or installation may cause Carbon Monoxide Poisoning. Carbon Monoxide, is an colorless and odorless gas, and is a by-product of combustion. Caution must be taken to insure the fireplace is properly vented when logs are in use To avoid having potentially dangerous fumes enter the living area, be sure the chimney is drawing properly and has sufficient draft.

WARNING: Do not burn wood, solid fuels, or other material in any fireplace fitted with a gas log set.

Do not store gasoline ammable vapors and liquids in the vicinity of this or any other appliance.

Do not place clothing or other flammable material on or near the appliance.

Children and adults should be alearted to the hazards of high surface temperature and should be kept clear to avoid burns or clothing ignition.

- Young children should be carefully supervised when they are in the same room as the appliance.
- Do not use this appliance if any part has been under water. Immediately call a qualified service technician to inspect the appliance and to replace any part of the control system and any gas control which has been under water.
- A fireplace screen must be in place when appliance is operating. Unless other provisions are made for combustion air, the fireplace screen must have provisions for combustion air.
- Installation of this Energy Efficient Gas Log Set and provisions for combustion and ventilation air must conform with the National Fuel Gas Code ANSI Z21-84 and appliance local codes.
- This gas log set is only to be installed and burned in a fully vented fireplace with a fully functional damper and chimney that is free of any obstructions. The fireplace must be constructed of non-combustible materials and approved to burn wood.
- To operate this gas log set, the fireplace damper must be fully opened and locked.
- The smallest or minimum dimension of the chimney flue must be 8 inches in diameter . Do not use an Energy efficient Gas Log Set if it is smaller than 8 inches. Do not use an Energy Efficient Gas Log Set if fumes from the burner emerge into the room when the damper is fully open. This indicates that there is not adequate draft for this log set and it must not be used until the fireplace draft is corrected.
- This appliance must be installed with a Damper Stop Clamp (Part #14). When operating this gas log set, the flue damper must be fully open.
- The nominal inlet gas pressure for this appliance is 7" water column for natural gas.
- This appliance must also be disconnected from th e gas supply system by closing its individual manual shutoff valve during any pressure testing at pressure equal to or less than 1/2 PSIG.

FIREPLACE PREPERATION

- A. Professionally clean chimney and fireplace floor of any combustible material to limit the smell from the system.
- B. Open fireplace damper fully and install Damper Stop Clamp with 1/4x2" set screw (Part 14#). This clamp is Designed to allow any pilot combustion by-products to vent (See **Fig.2**) Should the Damper Stop Clamp supplied not fit, a permanant damper stop clamp must be installed that will keep the damper open at a distance of not less than 1 1/2".
The damper must be in the fully open position anytime the unit is in operation.
- C. Prior to connecting the gas log set, make sure that the gas supply to the fireplace is completely shut off.

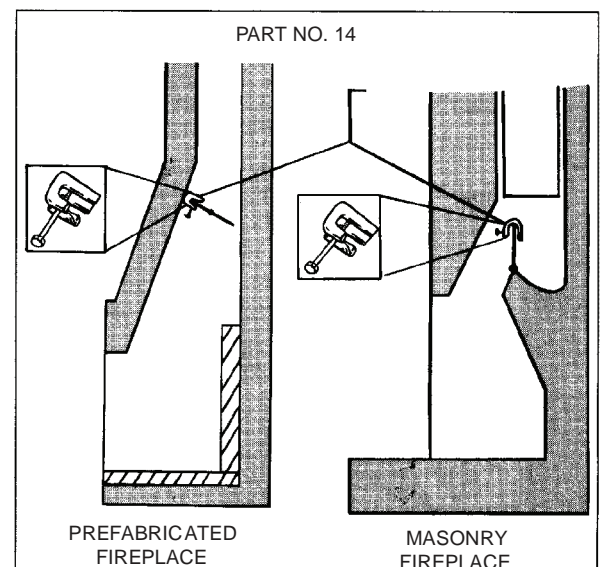

Figure 2. Damper stop clamp

- D. **Prefabricated fireplace:** Refer to the manufacturer's fireplace instruction manual for specific information regarding the running of a gas line into that particular model. A typical installation involves the insertion of a 1/2 inch gas pipe through the gas line tube provided by the manufacturer from **outside** the fireplace. The Knockout on the inside of the fireplace is removed as the gas pipe is punched through the fireplace. (See **Figure 3**).
- E. **Masonry fireplace:** A 1/2 inch gas supply line must be provided to the firebox. Most installations require drilling an access hole through the masonry wall. The supply line should be secured and sealed by mortar within the access hole. The supply line should also have a shutoff valve either in the wall or inside the fireplace (see **Figure 4**).

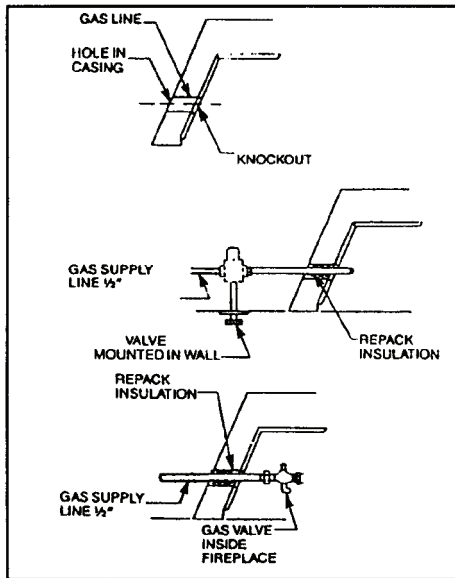

Figure 3. Gas line installation - Prefabricated Fireplace

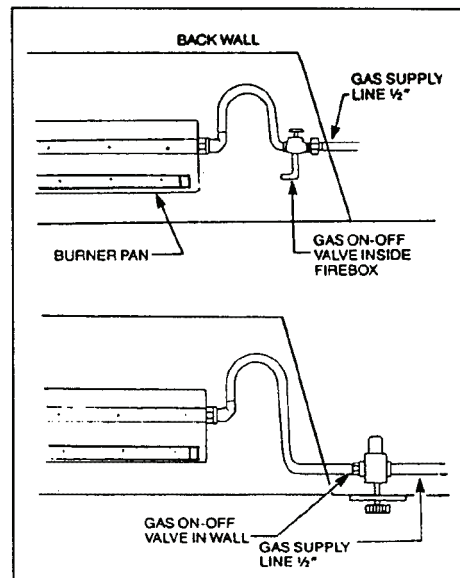

Figure 4. Gas line installation - Masonry Fireplace

GAS LOG INSTALLATION

(See **Figure 1** Parts List as a guide to reference part numbers.)

BURNER PAN INSTALLATION

NOTE: Use pipe compound on all male threads to seal joints.

- A. Determine if the fireplace has a right or left hand gas line feed. The circular "Dimpled" hole covering must be knocked out on the appropriate side (right or left) of the burner pan.
NOTE: Brace pan on workbench when removing burner knock-out. Strike knock-out plug with a punch or drift.
- B. Locate 3/8" locknut (Part #12) and washer (Part #21), and attach them to the 3/8" brass orifice elbow (Part #11) Do not fasten the locknut on the "flared" end.
- C. Slide the 3/4" burner support spacer (Part # 10) over the Dual Burner bar (Part #9) and move spacer to opposite side of the gas inlet connection (See **Figure 5**).
- D. Secure the intake end of the Dual burner bar (Part # 9) to the burner pan (Part # 8) through the knock-out hole selected (right or left hand) with the 3/8" brass orifice elbow (Part # 11), 3/8" locknut (Part # 12), and washer (Part #21) previously assembled in Step B (See **Figure 6**).
- E. Tighten elbow until firmly attached to the Dual burner pan. Then, firmly tighten the attached lock-nut on the elbow to seal the burner bar to the wall of the burner pan.

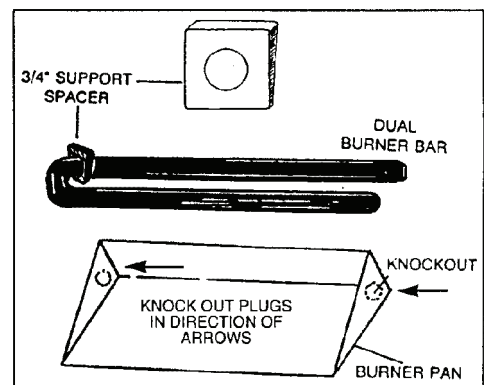

Figure 5. Burner bar placement

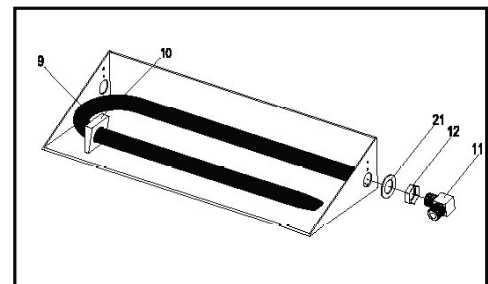

Figure 6. Burner bar connection

CONNECTING GAS SUPPLY TO BURNER ASSEMBLY

Natural Gas applications installed without a Safety Pilot Kit. LP/NG Safety Pilot Kit available at your local store (If a Safety Pilot Kit is to be used, please refer to separate instructions included with the kit.)

- A. Place burner pan assembly in the center of the fireplace.
- B. Attach 3/8" Flare X 1/2" NPT gas valve (Part #13) to the 1/2 inch gas supply stub already in fireplace. Be certain connections are tight and use pipe compound on all male NPT (pipe) threads to seal joints.
- C. Attach 3/8" flared tubing (Part #15) to burner pan assembly. Attach opposite end to gas supply line by carefully bending the flared tubing as needed to make the connection. Avoid kinking the tubing while bending. If tubing must be cut, use a tubing cutter. Flare the cut end of tube with a flaring tool.
NOTE: A good method of bending the tube is to fill it with sand, bending the tube as needed to make the connection. This method will eliminate kinking in the line. Once the tube is in the desired configuration, be sure to **empty** the tube completely of any sand before tube is connected to the gas supply line and burner assembly.
- D. Be certain all connections are tight. Only use pipe compound on all male NPT (pipe) threads. Test all connections with a soapy water solution, and with the gas supply turned on. If bubbles appear on any connection, tighten and re-test. Once it is determined there are no leaks whatsoever, turn off gas supply and move to next assembly step.

GRANULE, EMBER AND GRATE PLACEMENT

- A. Spread granules (Part # 16) over the installed burner pan. Granules should be sloped to the same angle as the burner pan filling the entire pan. (See Figure 7A.)
- B. Spread glowing embers (Part # 17) evenly over the top of the granules covering the entire surface area, concentrating on the front and sides of the burner pan for the most realistic burning effect.
- C. Place log grate (Part # 7) over the burner pan aligning as shown. (See Figure 7B.)
- D. Attach back log Standoff (Part # 18) to the back part of the grate. (See Figure 7B.)

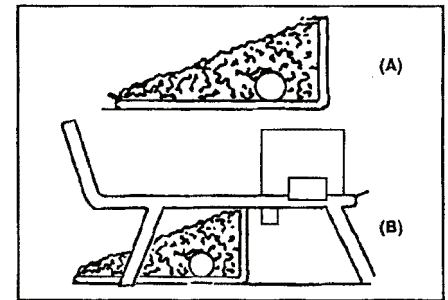

Figure 7 (A & B) Granule and Grate Placement

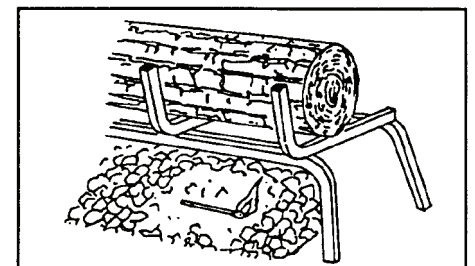

Figure 8. Lighting the log set

LIGHTING YOUR GAS LOG SET

(Manual Valve only)

- A. Open chimney flue damper to the full open position.
- B. Be sure gas supply is shut off.
- C. Lay match on top of embers and granules near gas burner input.
Do not hold match in hand (See **Figure 8**).
- D. With match burning, slowly turn on gas.

LOG PLACEMENT

MODEL: BRO18NG



Log Identification



Back Log Stand-Offs in place



Place log (1) onto back left area of the grate, perpendicular to log (2)



Place log (3) at the front right of the grate with the "burned" area to the flame



Place "Y" shaped log (4) onto left of the grate ahead of raised area



Place log (5) atop log (4), brace on left center grate finger



Place log (6) atop logs (1) and (3)



Place the two small logs (7) and (8) in front of the grate as shown

LOG PLACEMENT

MODEL: BRO24

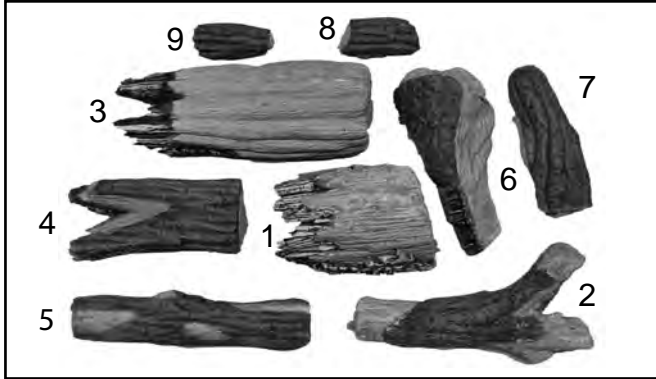

Log Identification



Back Log Stand-Offs in place

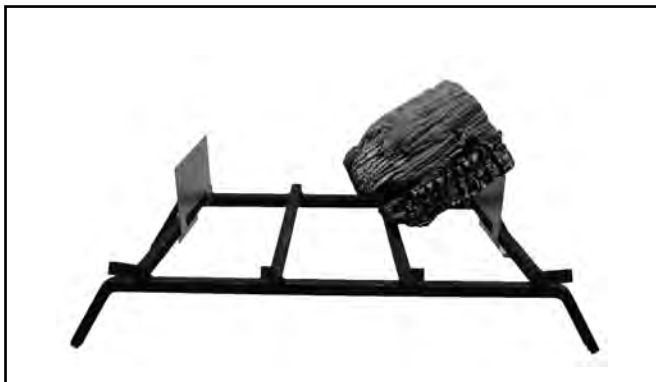

Place log (1) onto back right area of the grate

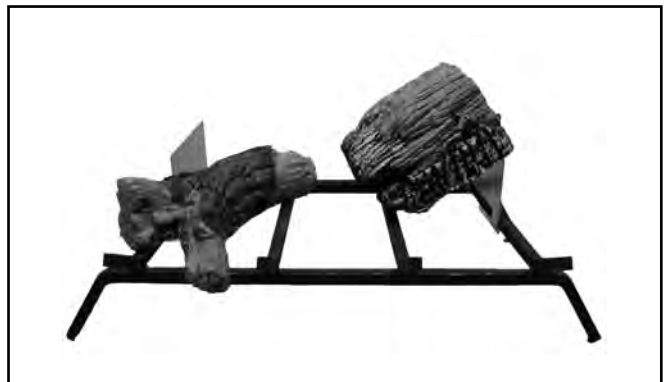

Place "Y" shaped log (2) onto left of the grate ahead of raised area



Place log (3) onto back left area of the grate, perpendicular to log (1)

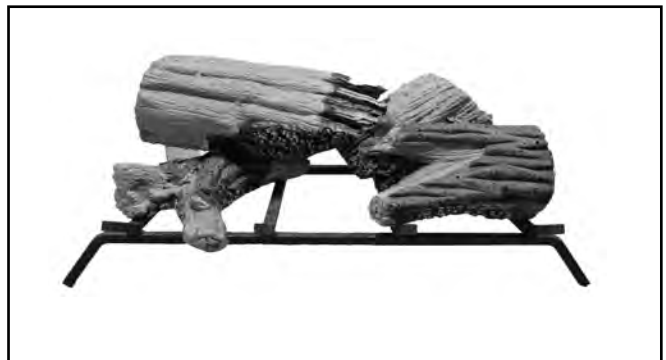

Place log (4) at the front right of the grate with the "split" area to the flame



Place log (5) on to log (2) and brace it on the grate finger left of center



Place log (6) atop logs (5) and (4) as shown

LOG PLACEMENT

MODEL: BRO24 Continued



Place the two small logs (7) and (8) in front of the grate as shown

LOG PLACEMENT

MODEL: CSO24/CSO30

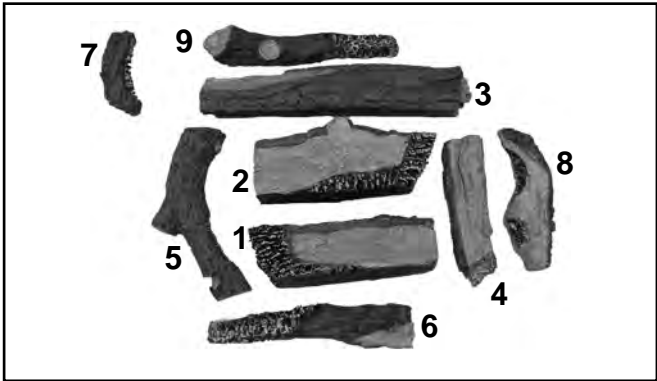

Log Identification

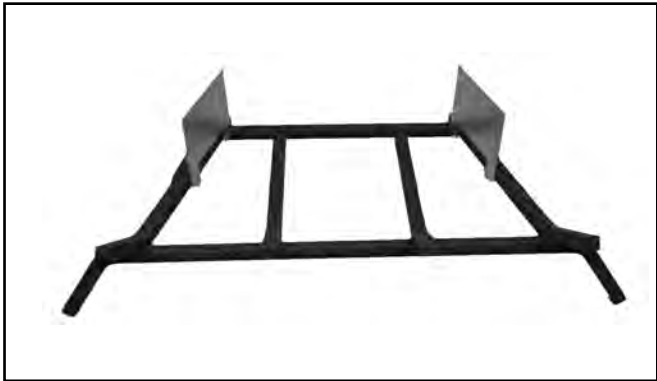

Back Log Stand-Offs in place

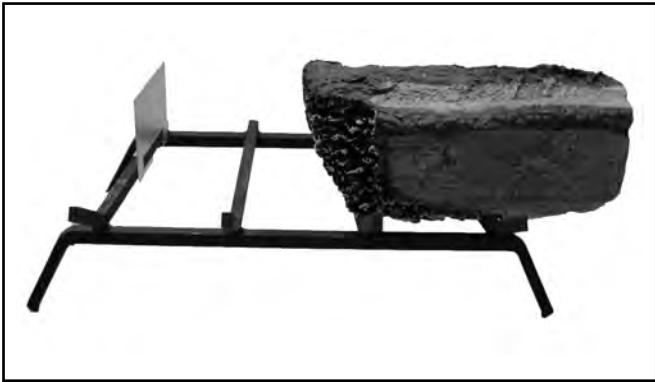

Place Right front log (1) onto front area of the grate



Place left front log (2) onto front area of the grate



Place back log (3) onto raised area of the grate



Place Cross-Log (4) at the center left



Place "Y" shaped Cross-Log (5) at right



Place Cross-Log (6) from front left to lay on log (5) as shown

LOG PLACEMENT

MODEL: CSO24/CSO30 Continued

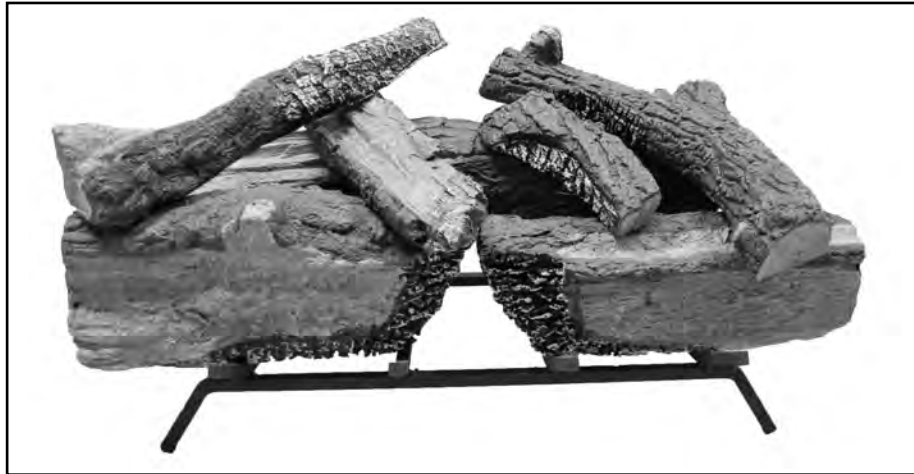

Place Cross-Log (7) at the center right

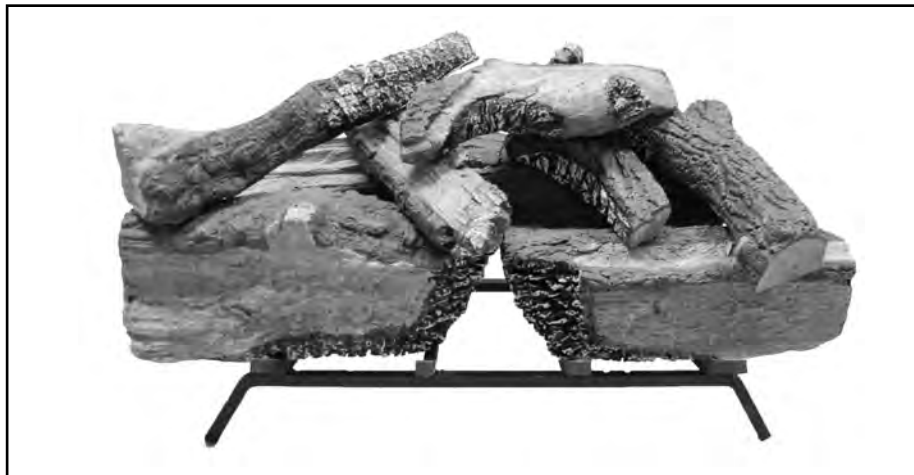

**Place Cross-Log (8) at the top center
across logs (5) and (7)**



**Place log (8) in front of the set, on the fireplace floor
Make sure it is in front of the burner pan**

LOG PLACEMENT

MODEL: MO24NG



Log Identification

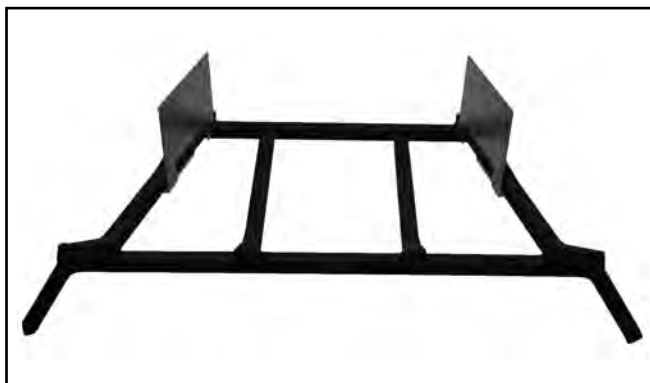

Back Log Stand-Offs in place

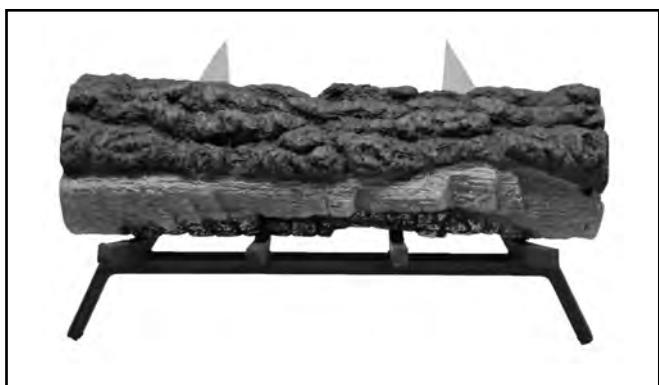

Place Main Front Log (1) onto front area of the grate

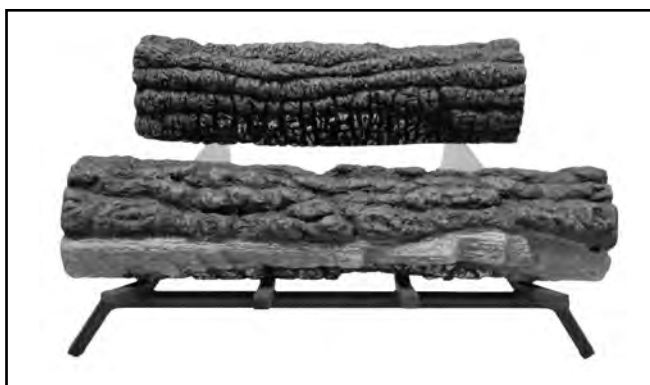

Place shorter back log (2) onto Back Log Stand-Offs

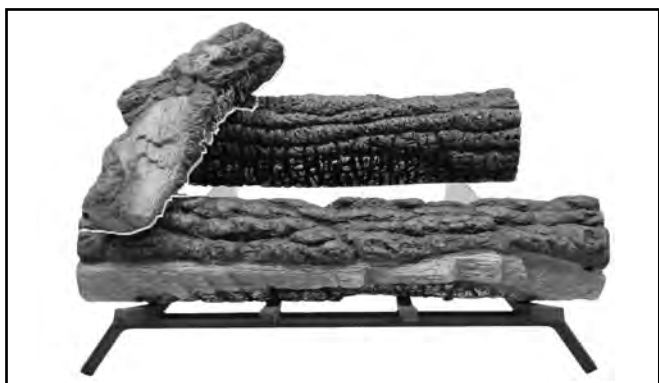

Place Cross-Log (3) at the left side



Place Cross-Log (4) at the center

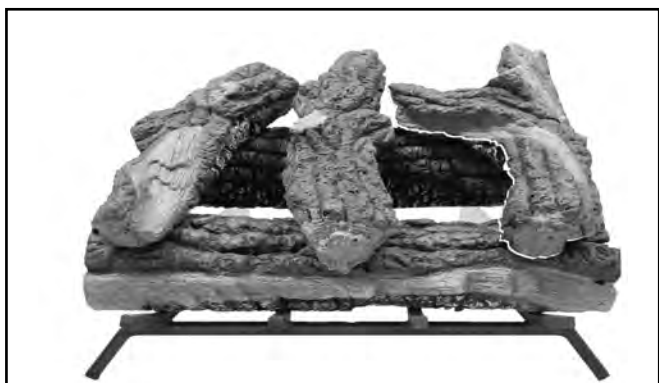

Place Cross-Log (5) at the right side



Place Cross-Log (6) from the center to the right side

LOG PLACEMENT

MODEL: MO24NG Continued



**Place Cross-Log (7) atop the center
Left (4) to the center right (5) logs**

LOG PLACEMENT

MODEL: SH18NG

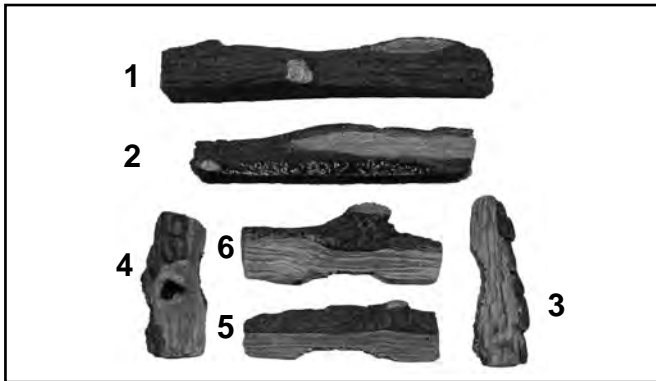

Log Identification



Back Log Stand-Offs in place



Place main front log (1) onto front area of the grate



Place shorter back log (2) onto raised area of the grate

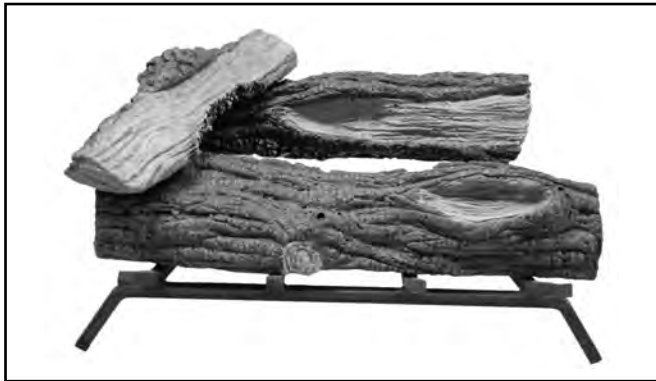

Place Cross-Log (3) at the left side



Place Cross-Log (4) at the right side



Place Cross-Log (5) at the center



Place Cross-Log (6) from the center to the right side

LOG PLACEMENT

MODEL: SH24NG



Log Identification



Back Log Stand-Offs in place



**Place main front log (1)
onto front area of the grate**



**Place shorter back log (2)
onto raised area of the grate**



Place Cross-Log (3) at the left side



Place Cross-Log (4) at the center left



Place Cross-Log (5) at the center right



Place Cross-Log (6) at the right side

LOG PLACEMENT

MODEL: SH24NG Continued



**Place cross-log (7) atop cross-log (6) and
to front center as shown**

MAINTENANCE

Very little maintenance is required. The carbon deposit resulting from combustion is natural and adds to the realistic appearance of the set. If carbon becomes excessive it can be lightly brushed or vacuumed away.

TROUBLE SHOOTING

<u>Problem</u>	<u>Cause</u>	<u>Corrective Action</u>
1. No Ignition	-Valve not fully in "on" position -gas line obstruction	-turn valve to "on" position -inspect supply lines/ tube for kinks or obstructions
2. Inadequate flame	-Valve partially closed -gas line partial obstruction -log arrangement incorrect	-open valve fully -inspect burner tube for kinks or obstructions -rearrange logs to specified pattern

LIMITED WARRANTY

Warranty shall apply to the original purchaser at the original installation point only.

All logs are guaranteed for three years against manufacturer's defects.

The burner assembly system is guaranteed for a period of (3) years from the date of purchase and will be replaced for freight costs only.

Pilot, valves and thermocouples are guaranteed for a period of one(1) year under the original manufacturers warranty.

General Warranty: This warranty does not apply in the case of improper installation, neglect, accident, misuse or as a result of modifications of the original product.

All costs for removal and re-installation are the expressed responsibility of the purchaser.

For repair, replacement, or service to defective part(s) please contact our Customer Service Hotline, number below. Thereafter with valid warranty registration and proof of purchase, call the Customer Service Hotline for authorization to ship defective part prepaid and insured in original carton to Sure Heat Manufacturing.

1861 West Oak Partway, Marietta, GA 30062. Goods returned improperly packaged are the sole responsibility of purchaser.

It is agreed that any repair or replacement is the exclusive remedy from Sure Heat Manufacturing. In no case shall Sure Heat be liable for any consequential damage or breach of this or any other warranty expressed or implied whatsoever. This limitation as to consequential damages shall not apply in states where prohibited.

Purchased From: _____ Date: _____

Size: 18" 24" 30"

Model:

Name: _____ Phone: _____

Address: _____

City: _____ State: _____ Zip: _____

Please photocopy and return to SHM International within 14 days of purchase

If you have other questions, please contact the Customer Service Hotline - (800) 229-5647